

Notice for specifications

I.U. = Indoor Unit O.U. = Outdoor Unit Qu = Quiet * = Not decided yet

- Specifications and design are subject to change without notice for future improvement.
- For further details, please check with our authorised dealer.
- Cooling/Heating capacities are based on the following conditions.

Cooling	Indoor temp. : 27°C DB/19°C WB Outdoor temp.: 35°C DB/24°C WB	Heating	Indoor temp. : 20°C DB Outdoor temp.: 7°C DB/6°C WB
---------	--	---------	--

- Performance test is in accordance with EN14511
- Seasonal efficiency test is in accordance with EN14825
- Sound power test is in accordance with EN12102



Fujitsu General (Thailand) Co., Ltd.



ISO 9001 Certified number: 01 100 075229
ISO 14001 Certified number: 01 104 9245

Fujitsu General (Shanghai) Co., Ltd.



ISO 9001 Certified number: 01 100 79269
ISO 14001 Certified number: CNB312244-LK

Fujitsu General Central Air-conditioner (Wuxi) Co., Ltd.



ISO 9001 Certified number: 15917020073R5M
ISO 14001 Certified number: 15918C20021R5M

- The products or equipments in this catalogue contain fluorinated greenhouse gases.
- **AIRSTAGE** and **WATERSTAGE** are worldwide trademarks of FUJITSU GENERAL LIMITED and are registered trademarks in Japan and other countries or areas.
- **nocria** is a worldwide trademark of FUJITSU GENERAL LIMITED.
- **FCUair** is a worldwide trademark of FUJITSU GENERAL LIMITED.
- **Apple** is a trademark of FUJITSU GENERAL LIMITED.
- iPhone and iPod touch are trademarks of Apple Inc., registered in the U.S. and other countries.
- "Microsoft", "Windows", "Direct X" are trademarks of Microsoft Corporation in the United States and certain other countries.
- "BACnet" is a trademark or registered trademark of the American Society of Heating, Refrigerating and Air-Conditioning Engineers, Inc.
- "MODBUS" is a registered trademark of Schneider Electric.
- "LONWORKS" and Echelon are trademarks of Echelon Corporation registered in the United States and other countries.
- "Adobe" and "Acrobat Reader" are either registered trademarks or trademarks of Adobe in the United States and/or other countries.
- "Android" is a trademark of Google LLC.
- Other company and product names mentioned herein may be registered trademarks, trademarks or trade names of their respective owners.



AIR CONDITIONERS LINEUP PRODUCT CATALOGUE 2021

PRODUCT CATALOGUE 2021

AIR CONDITIONERS LINEUP

FUJITSU GENERAL LIMITED

FUJITSU GENERAL LIMITED
3-3-17, Suenaga, Takatsu-ku, Kawasaki, Kanagawa,
213-8502, Japan
www.fujitsu-general.com



Copyright© 2008-2021 Fujitsu General Limited. All rights reserved. 3EF029-2110E

FUJITSU GENERAL LIMITED

The FUJITSU GENERAL Way

Our mission

Living together for our future

Through innovation and technology, we deliver a brighter future with peace of mind to our customers and societies around the world.

Our philosophy

Act spontaneously

We embrace new challenges by investing in ourselves for personal growth, and through continuous creativity with a spontaneous attitude.

Develop or team

We respect and value our people, and optimize their abilities through fostering culture and diversity, and utilizing a collaborative effort focused on communication.

Value integrity

To achieve our goals, we always act with integrity and shared ethics.

CONTENTS

004 OUR MESSAGE

Innovation and Technology

006 Cleanliness

008 Future

010 Comfort

012 Control

014 Design

016 History

018 Worldwide Locations

020 Global Business Activities

022 Project References

024 Global Development & Production Bases

026 High-Quality Development & Production Facilities

028 2021 New Products

032 SOLUTIONS

034 For Light Commercial Use

042 For Commercial Use

044 For Residential Use

PRODUCT LINEUP

SPLIT & MULTI-SPLIT

VRF

VENTILATION

CONTROL SYSTEM & OPTIONAL PARTS

AIR TO WATER

SUPPORT

Sp-002 AIRSTAGE™ Support

Sp-004 AIRSTAGE™/RAC Support Tool

Sp-006 WATERSTAGE™ Support Tool

Sp-008 Quick Service & Maintenance

Sp-010 Service Tool

Web Monitoring Tool

OUR MESSAGE



for Cleanliness

**Innovation &
Globalization**



for Future



for Comfort



for Control



for Design

We create comfortable lives for people around the world with "made-in-Japan quality" and innovative manufacturing.



History



Worldwide locations



Global business activities



Project references



Global development & Production bases



High-quality development & Production facilities



Cleanliness

Think about air quality

Fresh air is essential for comfortable air conditioning. Fujitsu General offers a wide range of air conditioning products with air purification functions, such as ventilation systems equipped with high-performance filters and heat exchangers.



Collecting dust particles to clean the air



Silver Ion Filter

The Silver ion filter helps to keep indoor air free from viruses, bacteria and molds. Notice: Not a result of experiments in an actual use environment. Silver ion filter inhibits activity or growth of microorganism, but do not prevent infection.

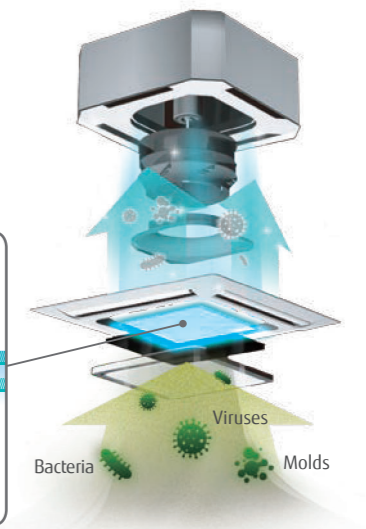
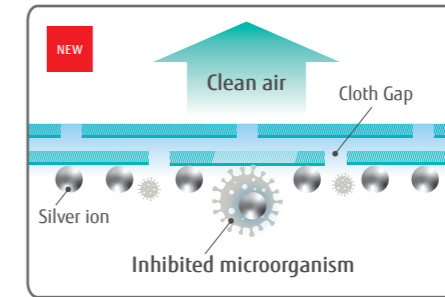

Plasma Air Clean

Air passing through the indoor unit is cleaned by a built-in electrostatic dust collector. Pollen, house dust and other tiny pollutants are collected and removed with static electricity.

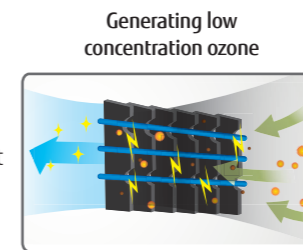

Apple-catechin Filter

The Apple-catechin filter uses static electricity to remove fine particles and dust from the air.

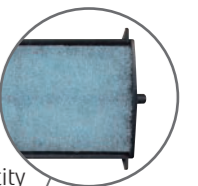

Different filters are used on each side

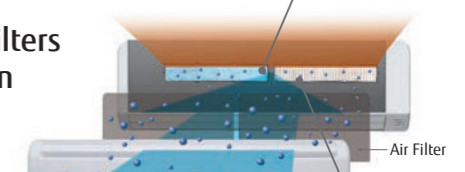

Ion Deodorization Filter

Deodorizes the air by decomposing absorbed odors using the oxidizing and odor-reducing effects of ions generated by ultra-fine particle ceramic.



Ventilation with adequate airflow with reduced temperature changes

Heat Exchange Ventilation

When a room is cooled or heated, the exhausted cooling or heating energy is recovered by heat exchange ventilation.

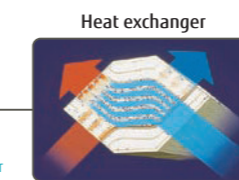

Adopts a high-efficiency counterflow heat exchange element

Air handling unit

The Air handling units connected to Fujitsu General's AIRSTAGE™ system are equipped with technology that provides high energy efficiency and superior comfort to meet the most stringent air conditioning requirements and installation conditions.





The Green refrigerant

Throughout our research and development process, we are constantly striving to create products that we can be proud of in the future. The technologies we have cultivated through these efforts are incorporated into our environmentally friendly products, and are recognized in the European market, which has extremely strict environmental regulations.

R32 refrigerant with reduced global warming potential

- **Zero** Ozone Depletion Potential (ODP^{*1})
- High environmental properties
- High performance
- Economically efficient

^{*1} **ODP (Ozone Depleting Potential)**: a relative value that indicates the impact per unit weight of ozone-depleting substances released into the atmosphere when CFC-11 (trichlorofluoromethane, CCl3F) is fixed at 1.0

^{*2} **GWP (Global Warming Potential)**: a measurement that indicates how much other greenhouse gases are capable of warming the Earth based on carbon dioxide. This is the integrated value of radiant energy given to the Earth (i.e., the estimated impact on global warming) expressed as a ratio to CO₂.

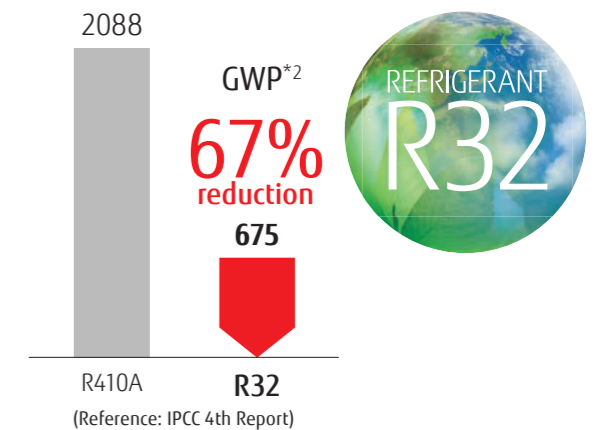

Our pioneering efforts to create a green future

Fujitsu General follows the EU Climate Action Plan 20/20/20 by 2020.

20% Less primary energy use

Fujitsu General's energy-efficient air conditioners are designed to consume less electricity, thus reducing primary energy usage.

20% Less CO₂ emissions

Fujitsu General products closely follow the F-Gas regulation 517/2014/EU.

20% Coming from renewable energy

Fujitsu General is promoting air sourced heat pumps as renewable energy source heating systems

New energy labelling requirement 626/2011/EU

Our air conditioners have reached the "Class A+++" ranking, the highest energy efficiency level that is now shown on energy labels in Europe.

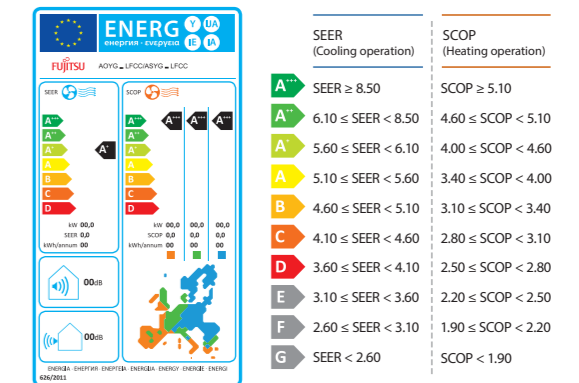

Less is more

Space Noise Refrigerant

Less Space

Improved installation flexibility

Our class-leading compact outdoor units range from 8 to 18 HP, and their flexibility in installation does not detract from the appearance of the building.

Installation area **Weight (18 HP model)**

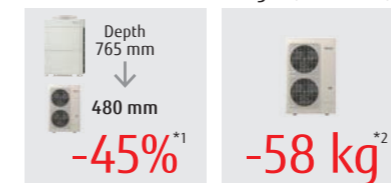

Less Refrigerant

Refrigerant saving design

The compact indoor unit, piping design, and optimization of heat exchanger volume significantly reduce the system refrigerant volume.

System refrigerant volume

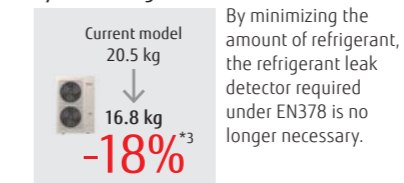

VRF outdoor units



Less Noise

Class-leading low operating sound

The outdoor units in this series are designed to operate extremely quietly. They are an ideal choice for installation in densely populated areas.

Sound power level (8 HP model)

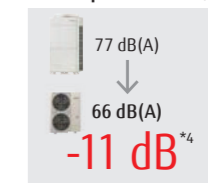

*1: J-IV Series are compared with V Series 14/16/18 HP models. *2: J-IV Series 18 HP model is compared with V-IV Series 18 HP models. *3: E.g.) when 30 indoor units are connected to 1 system (Outdoor unit: 12 HP; Indoor unit: 1.1 kW × 30; Total pipe length: 277.5 m) • J-IV Series is compared with current Series. *4: J-IVL Series 8 HP model is compared with V Series 8 HP



Comfort



Comfortable airflow design

Pursuing the potential of air conditioners and true comfort, Fujitsu General has developed and commercialized numerous world-first technologies, and these concepts are reflected in the design of our products.



Cassette type 3D flow Series
3 individually controlled air outlet ports
 The Comfortable airflow setting enables the right and left air outlet ports as well as the wide center port to work together to provide a comfortable room environment.

NEW

Cassette type One-way flow Series

Wide airflow range created by triangle design and large flap

A large flap with a wide range of movements, equipped with louvers arranged triangularly, sends air into every corner of the room.

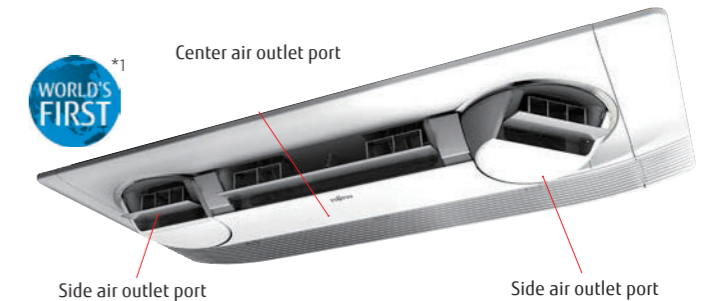

Center air outlet port

Side air outlet port

Side air outlet port



Cassette type Circular flow Series

Unique circular flow design

This Series realizes a Circular Flow to blow a large airflow in a 360° direction by using a high-performance DC fan motor, turbo fan, and a unique seamless airflow louver design.

KX Series

Wall-mounted type

Comfortable airflow control to prevent the body from being exposed to direct airflow

Hybrid Airflow, which combines air currents of different temperatures and velocities, creates a comfortable space.



Dual-fans

nocria X

Dual-fans



Comfort pursued through advanced technologies



Lambda heat exchanger^{*3}



Power diffuser^{*4}

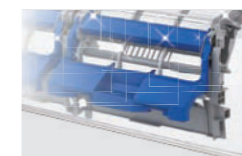

Filter auto clean^{*5}



Dual-fans^{*2}



3 Air outlet ports^{*1}

The dual-fans equipped with the flagship "nocria X" model optimally control airflow. The unique form brings a comfortable airflow to every corner of the room. The power diffuser opens the lower flap of the main unit and blows warm air downward to heat the room from the floor, increasing heating efficiency. The lambda heat exchanger improves the operating efficiency, contributing to the compactness of the indoor

units. In addition, the automatic filter cleaning function that we have developed ensures ease of maintenance and operating efficiency. The "nocria X" airflow control system is also used in the cassette type, creating a comfortable space with three types of airflow. Fujitsu General's unique technology enables the system to create a comfortable space.

*1: Announced 2018. In room air conditioner for the home (Our company's investigation) *2: Announced 2012. In room air conditioner for the home (Our company's investigation) *3: Announced 1994. In room air conditioner for the home (Our company's investigation) *4: Announced 1991. In room air conditioner for the home (Our company's investigation) *5: Announced 2002. In the category of room air conditioners for the home (Our company's investigation).



Control

User-friendly screen display enables easy operation.

With the WLAN adapter and the FGLair app, you can control the heating and cooling of your home anytime, anywhere.

Operation from Anywhere

Using the Internet of Things (IoT), Fujitsu General is actively providing services that allow users to control their air conditioners from their smartphones. We are also expanding our open co-creation activities with external partners to deepen the development of new functions and services using IoT and artificial intelligence (AI) to develop safe and convenient air conditioners.

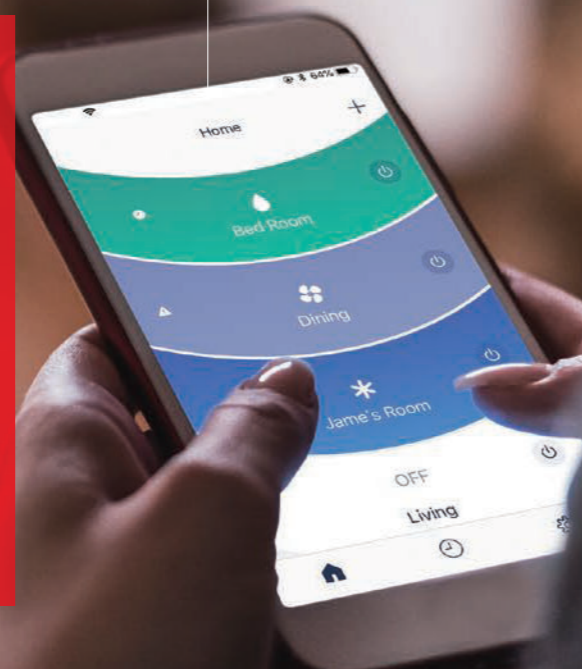

Should you forget to turn off the system before you leave home, you don't have to worry.

"FGLair" is a software application that allows users to control Fujitsu General air conditioners from anywhere outside with a mobile device while out or on the move.

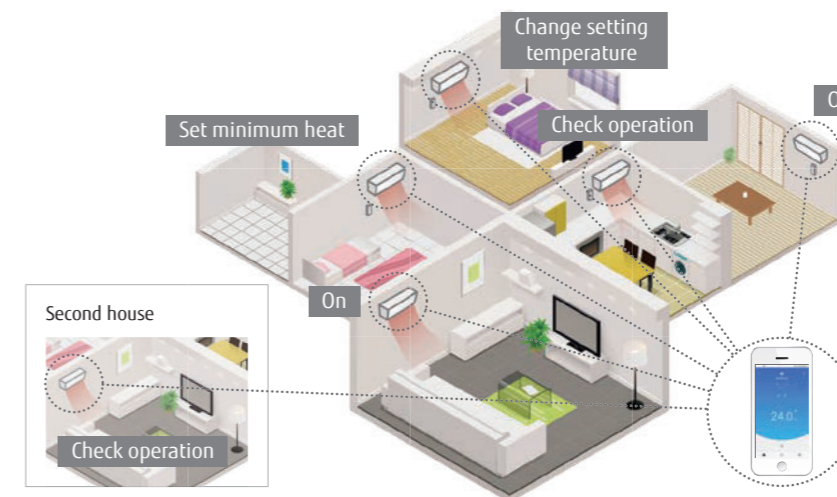

WLAN adapter

The dedicated WLAN adapter enables the air conditioner to be operated by smartphone or tablet PC from outside the home.



+

Download Free

Download on the App Store | Get it on Google play



Compact wired remote controller

Large screen and simple display

- Large screen, yet compact in size
- Large, easy-to-read letters are used.
- The controls are simple and easy to understand.



Central remote controller for VRF system

The central remote controller uses a touch panel screen to display multiple menus on the top screen. Just touch the menu you want to operate, and the necessary window will pop up, and allow intuitive operation.

Remote monitoring and operation

The central remote controller enables monitoring and control of a tenant's air conditioner anytime, anywhere.

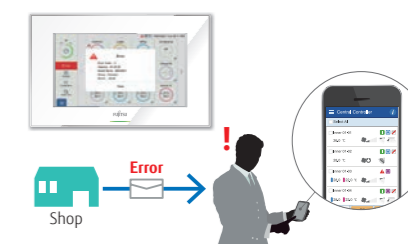



Create a Beautiful Space

Fujitsu General offers a wide range of products for the European market, including models with unique textural designs, award-winning models that integrate with room interiors, and Cassette type models with different designs that match office spaces. We also have a lineup of models with elegant designs, such as the Ceiling type models with its beautiful curved surface.

KE Series

Wall-mounted type

KE Designer Series

We have designed this series exclusively for the European market. The exterior design harmonizes beautifully with any decor and adds comfortable elegance to the room. The light, elegant and three-dimensional expression achieved by the curved surface looks beautiful from any angle.

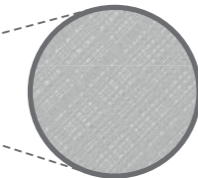

CMF: Color Material Finish

The texture of the front panel expresses the craftsmanship of Europe, and changes its expression with the changing light of the day.

Design award-winning products

Wall-mounted type, design Series



KG Series



LT Series



reddot design award winner 2012

Light Elegant Design

New Ceiling type design

The light, elegant and three-dimensional expression achieved by the curved surface gives a sense of comfort and well-being.



reddot winner 2020

Different Cassette type Designs



Compatible with grid ceiling systems
Compact cassette Series
for grid ceiling



Beautiful design from any angle
Cassette type Circular flow Series
White panel



For ambience with dimmed lighting
Cassette type Circular flow Series
Black panel



History

Yaou Shoten Ltd. established in 1936

Overseas air conditioning business since 1971

Starts air conditioning business in Japan in 1960

1971 Air conditioner exports to the Middle East.

1977 "Super Power, Super Quiet" Series released

1982 Window type 3 Super Series released

AL/AX Series



1985 Large wall-mounted type and multi-split air conditioner released.

WORLD'S FIRST *1,*2 1991 World's first air conditioner equipped with lambda heat exchanger

1994 World's first air conditioner with power diffuser

2001 AIRSTAGE™ Series released VRF air conditioners for large buildings



WORLD'S FIRST *3 2002 Air conditioner with the world's first automatic self-cleaning filter system

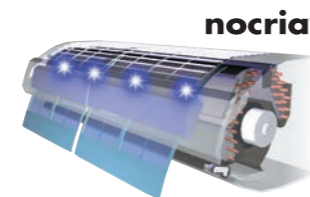

2004 Standalone Compact VRF AIRSTAGE™ J Series released



2006 VRF Heat Pump type Maximum 42 HP AIRSTAGE™ V Series released



2009 VRF Heat Pump Modular type Maximum 48 HP AIRSTAGE™ V-II Series released



2009 Air to water system released

WATERSTAGE

For Light commercial use

2011 High energy-saving type AIRSTAGE™ J-II Series released

2014 Compact & lightweight outdoor unit AIRSTAGE™ J-IIS equipped with a single fan for improved ease of installation

2016 Compact VRF AIRSTAGE™ J-III Series with advanced energy efficiency and easy installation released

2017-19 Compact VRF AIRSTAGE™ J-IIIIL Series for light commercial use released

2020 Compact & lightweight outdoor unit AIRSTAGE™ J-IVL, J-IV, J-IVS Series released



2019

New cassette style released
Cassette type 3D flow Series

For Commercial use

2012 Heat Recovery Modular type AIRSTAGE™ VR-II Series Maximum 48 HP released



2020

AIRSTAGE™ Air handling unit released

2014-15 Heat Pump Modular type AIRSTAGE™ V-III Series Maximum 54 HP for large buildings released

2020 Heat Recovery type AIRSTAGE™ VR-IV Series Maximum 48 HP released

For Residential use

2011 Hi-spec Design model LT Series & LU Series released

2017 Flagship Wall-mounted type "nocria X" released

2017-19 Added to this lineup recently are the environment-friendly R32 refrigerant models. (Split & Multi-split type)



For Light commercial use

AIRSTAGE
The new triangle design cassette One-way Flow Series released

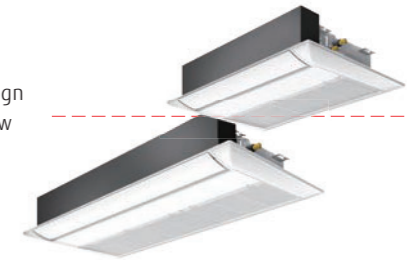

For Commercial use

For Residential use

R32 Multi-split and Air to water comfort Series 10 kW class released



3-unit, 4-unit, 5-unit Multi-split

Air to water Comfort series 10 kW class



WATERSTAGE

1950 ~

1970 ~

2000 ~

2010 ~

2021 What's New

Manufacturing Company Establishment

1955 Head Office established in Kawasaki

1964 Electronic components factory in Ichinoseki



1977 Air conditioner manufacturing company in Hamamatsu (now Hamamatsu business office)

1991 Air conditioner manufacturing company in Thailand

1994 Air conditioner manufacturing company in Shanghai, China

1998 Air conditioner motor manufacturing company in Thailand

2006 VRF air conditioner manufacturing, sale, and service company in China

2007 Air Conditioner Technology Building becomes operational on the premises of the Kawasaki Headquarters. Air conditioner R&D Center in Kawasaki

2009 Compressor Factory begins operation in Thailand

2012 Joint venture in Thailand to manufacture compressors

2016 Commercial use air conditioner R&D Center in Thailand



2019 New building constructed at Kawasaki Head Office to strengthen development capabilities:

Base for creating new value by combining internal and external knowledge



2020 Building IoT-based manufacturing

Implementing a real-time IoT system to instantly visualize and analyze various information



Fujitsu General (Thailand) Co., Ltd. (Thailand) Factory-2



Fujitsu General (UK) Co., Ltd. (UK)



Fujitsu General (EURO) GmbH

Sales & service maintenance company established

1976 North America sales company

1977 Europe sales company (UK)

1978 Australia sales company and Europe sales company (Germany)

1980 Brazil sales company

1997 Asia sales company (Singapore)

1998 Middle East sales company (UAE) and New Zealand sales company

2000 Air conditioner manufacturing and sale technical partnership in India

2002 Taiwan sales company

2006 China sales company

2016 THE AIRSTAGE™ on Broadway in New York



*1: Announced 1991. In room air conditioner for the home (Our company's investigation) *2: Announced 1994. In the category of room air conditioners for the home (Our company's investigation). *3: Announced 2002. In the category of room air conditioners for the home (Our company's investigation).

*4: Announced 2018. In room air conditioner for the home (Our company's investigation) *5: Announced 2012. In room air conditioner for the home (Our company's investigation)



Worldwide locations

Under a system of five bases in Europe, the Middle East, Asia and Oceania, North and South America, and Japan, the company promotes Globalization from a worldwide perspective while emphasizing the actual conditions in each region.



JAPAN Head Office



Technology research building (Japan)

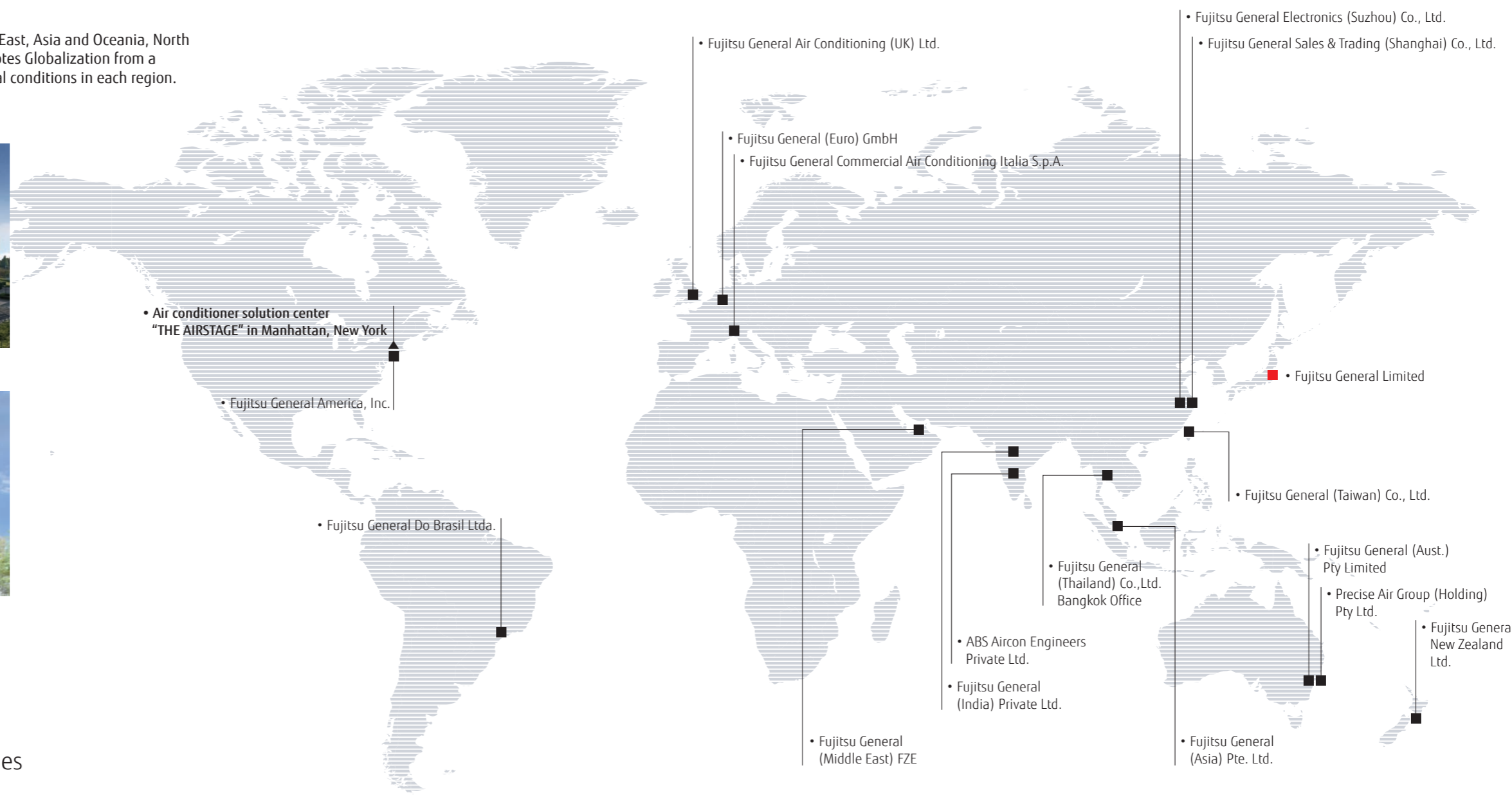

18 Overseas Sales Companies

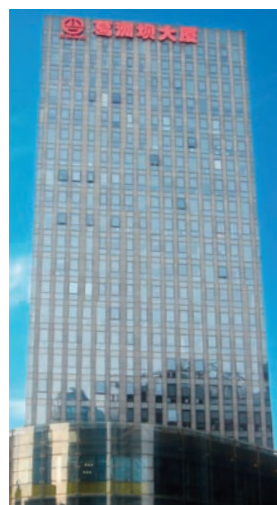

Fujitsu General Sales & Trading (Shanghai) Co., Ltd.



Fujitsu General (Taiwan) Co., Ltd. (Taiwan)



Fujitsu General (Thailand) Co.,Ltd. Bangkok Office (Thailand)



Fujitsu General (Asia) PTE. Ltd. (Singapore)



Fujitsu General (EURO) GmbH (Germany)



Fujitsu General Air Conditioning (UK) Ltd. (U.K.)



Fujitsu General Commercial Air Conditioning Italia S.p.A. (Italy)

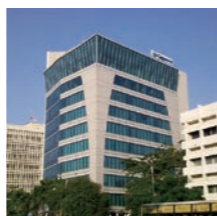

Fujitsu General (India) Private Ltd. (India)



Fujitsu General (Aust.) Pty building (Australia)



Precise Air Group (Holding) Pty Ltd. (Australia)



Fujitsu General New Zealand Ltd. (New Zealand)



Fujitsu General (Middle East) FZE (U.A.E.)



ABS Aircon Engineers Private Ltd. (India)

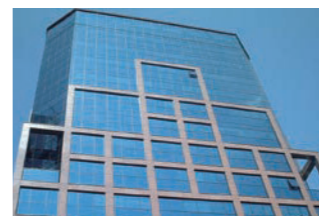

Fujitsu General Do Brasil Ltda. (Brasil)



Fujitsu General America, Inc. (U.S.A.)



FUJITSU GENERAL SOLUTION CENTER "THE AIRSTAGE" (U.S.A.)



Global business activities

We have been recognized for our activities in advertising, human resource development and customer service, as well as for our community-based social contribution activities in each region, winning numerous awards and achieving a high level of customer satisfaction.

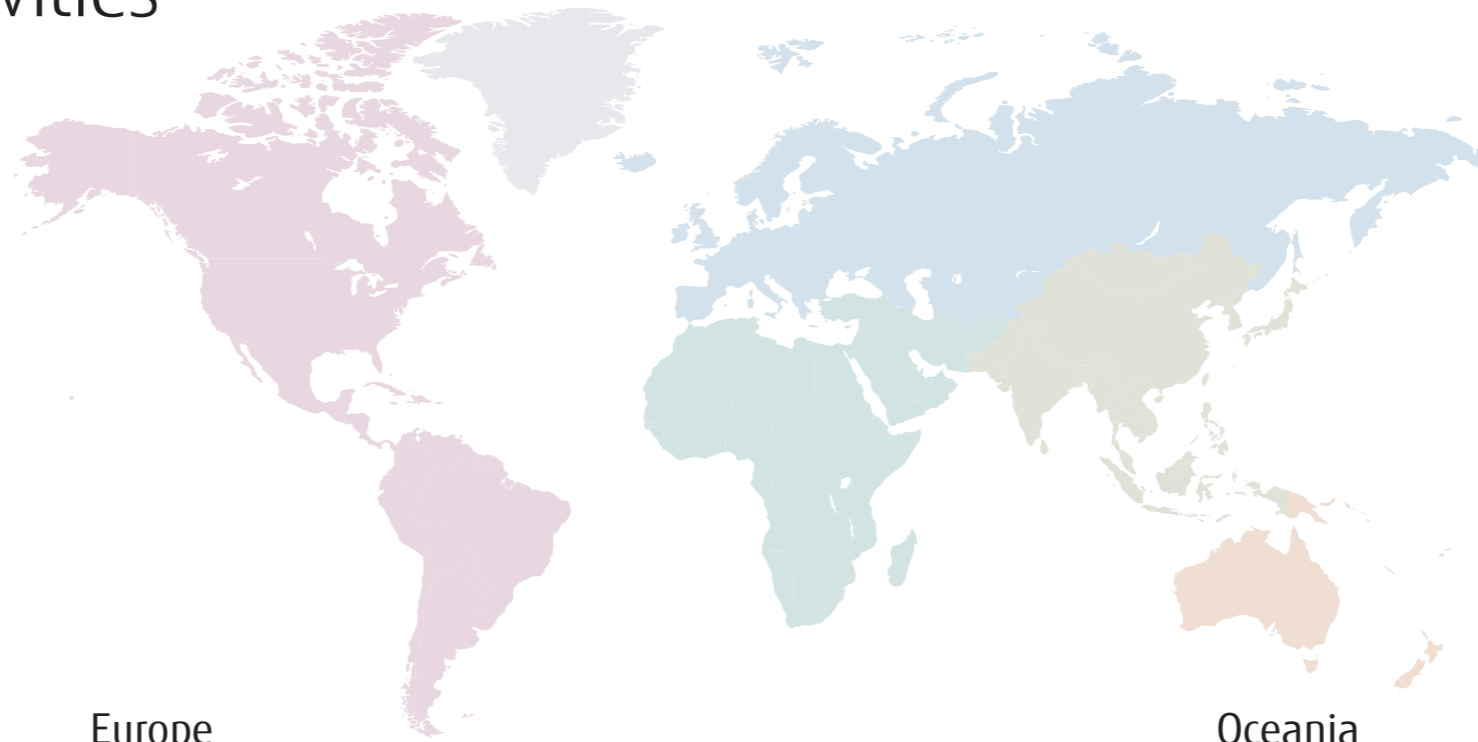

North and South Americas



AHR Expo



HVAC trade shows in Brazil



Distributor meeting



Call center

Middle East



Exhibition



Dealer Convention in Kuwait



Technical seminar



Training for dealers

Europe



HVAC trade show in European countries



Presentation & training



HVAC trade show in European countries



The ACR Show



Oceania

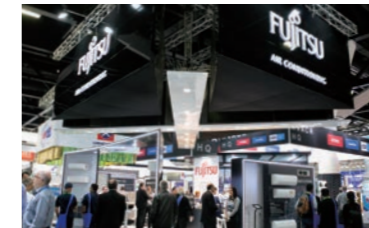

HVAC trade show in Australia



Charity activity (Christchurch)



Service & Maintenance

Asia



New product presentation meeting



Dealer convention in Thailand



Training



Call center

International authoritative design awards



the NEWS Dealer Design Awards



Gold Award (Category: HVAC & PLUMBING) in Reader's Choice Awards



TOP OF MIND 2016 First prize in "MARCA DE EQUIPAMENTO DE AR-CONDICIONADO" category of "CLIMATIZACAO" division



Superbrands is the world's largest independent arbiter of branding.



The iF Product Design Award is given annually by iF International Forum Design GmbH for industrial products from around the world.



The Plus X Award is the world's largest innovation award for technology, sports and lifestyle.



reddot winner 2020

A product design competition that has been held since 1955. Products that win the award are given the "Red Dot" seal, a sign of international recognition of quality.



Coolworld Industry Awards "Most Efficient Air Conditioner"



Canstar Blue Most Satisfied Customers Award



China State Construction Engineering Luban Prize



The Good Design Award is an award sponsored by the Japan Institute of Design Promotion, and is given once a year to items of outstanding design.



Project references

Introduced in over 50 countries worldwide

Highly popular for their excellent quality, energy efficiency, and ease of installation, Fujitsu General's products are installed in a wide range of buildings around the world, including high-rise office buildings, stores, hotels, public facilities, schools, hospitals, and residences.

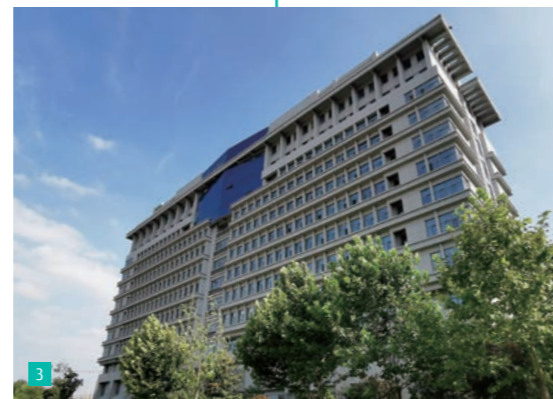

For Light commercial use

- 1 Bank in Europe
- 2 Museum in Europe
- 3 School in Asia
- 4 Hospital in Asia
- 5 School in the Middle East
- 6 Shop in Oceania
- 7 Public facility in the United States

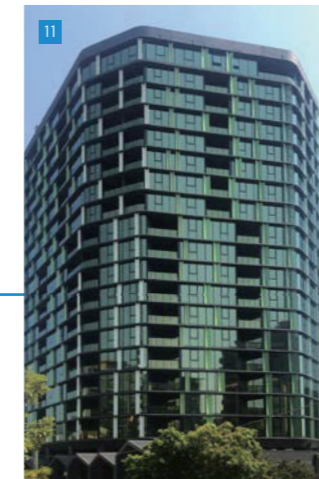
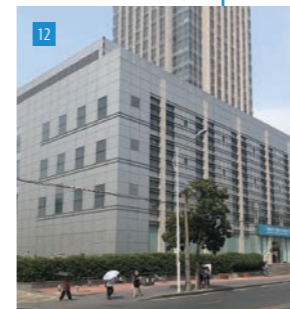
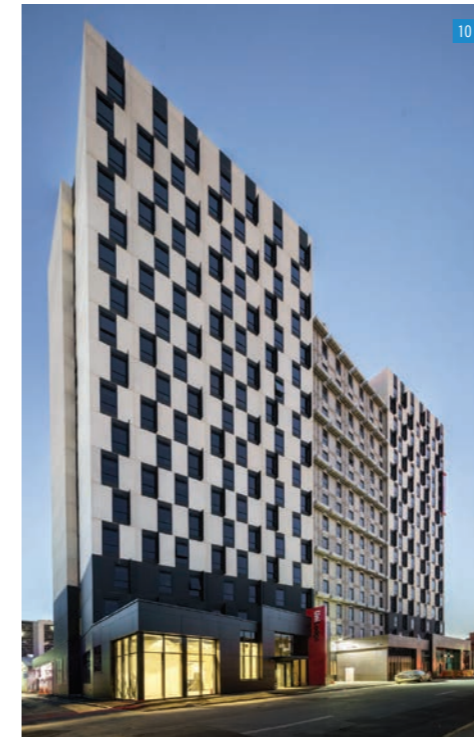

For Commercial use

- 8 Hotel in Asia
- 9 Office in Asia
- 10 Apartment in Oceania
- 11 Apartment in Oceania
- 12 Public facility in Asia
- 13 Hotel in the Middle East

For Residential use

- 14 Residence in Oceania
- 15 Residence in the United States
- 16 Villa in the Middle East





Global development & Production bases

We have established R&D bases in five countries from Japan, Europe, Asia, China, and North America to pursue environmental properties and comfort according to the needs of each region.

- Head office
- R&D center
- Manufacturing companies



R&D center & Technology Research Building



R&D center in Fujitsu General (EURO) GmbH (Germany)



North America R&D Center (USA)



Fujitsu General Air Conditioning R&D (Thailand) Co., Ltd. (Thailand)



R&D center in Fujitsu General (Shanghai)



JAPAN Head office, R&D center and 60 m height difference testing tower (Japan)

Technology research building in Japan Head office



Constructing IoT-based manufacturing
We are implementing a real-time IoT-enabled system to immediately visualize and analyze various information such as facility operating status, assembly line production progress, and parts inventory and transportation status. This will further enhance the accuracy of production and shipping forecasts in the Head Office and factory management departments. The system will also help improve activities by employees at production sites, with the aim of improving the efficiency of the production process, the efficiency of parts distribution operations, and the utilization rates of the facilities.

Overseas manufacturing companies



Fujitsu General (Shanghai) Co., Ltd. (China)



F.G.L.S. Electric Co., Ltd. (China)



Fujitsu General Central Air-conditioner (Wuxi) Co., Ltd. (China)



Fujitsu General Electronics Ltd. (Japan)



Fujitsu General (Thailand) Co., Ltd. (Thailand) Factory-2



Fujitsu General (Thailand) Co., Ltd. (Thailand)

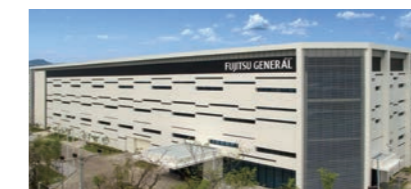

Fujitsu General Air Conditioning R&D (Thailand) Co., Ltd. (Thailand)



FGA (Thailand) Co., Ltd. (Thailand)



TCFG Compressor (Thailand) Co., Ltd. (Thailand)



High-quality development & Production facilities

Advanced Research Facilities and Equipment

Performance tests



Airflow measurement room
Measure the airflow of air conditioners, from compact room air conditioner models to variable refrigerant flow (VRF) systems.



Calorimeter
Measure the temperature, humidity, and airflow at the inlet and outlet of the air conditioner to evaluate its cooling and heating capacity.



Silent room
Measure the operating sounds of air conditioners on walls and ceilings with reduced sound reflection.

Fujitsu General is one of Japan's leading manufacturers with R&D centers in Japan. The research and development conducted in these facilities contributes to providing our customers with the highest quality and performance.

Reliability tests

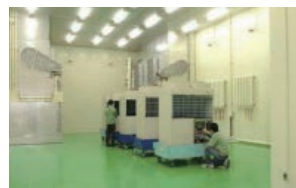

Constant temperature room
Verify product performance in cooling and heating operations under various temperature and humidity conditions.

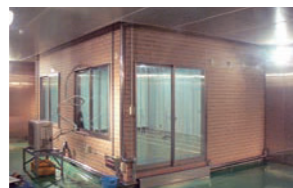

Practical test room
Check whether the performance of the air conditioner can be sustained under the conditions of the actual housing environment.



Shower test room
Check if the electrical box of the outdoor unit is protected from strong wind and rain, such as during a typhoon.

Transportation and Handling Tests



Compressibility test



Vibration test



Technology research building in Japan Head office

Testing laboratory

Fujitsu General EMC Laboratory Limited

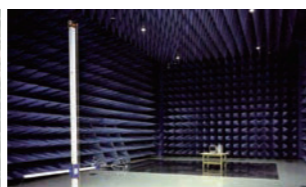
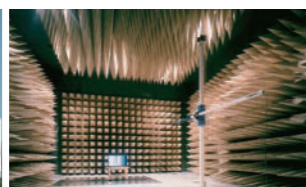

60-m Height Difference testing tower

Tests oil circulation in a compressor for reliability.



Certification of ISO 9001 and ISO 14001

■ ISO 9001
■ ISO 14001
() Number of companies

The Group's 5 overseas production subsidiaries are individually certified with ISO 9001 and ISO 14001. The Group's 11 overseas sales subsidiaries have been certified with ISO 14001 since 2012.

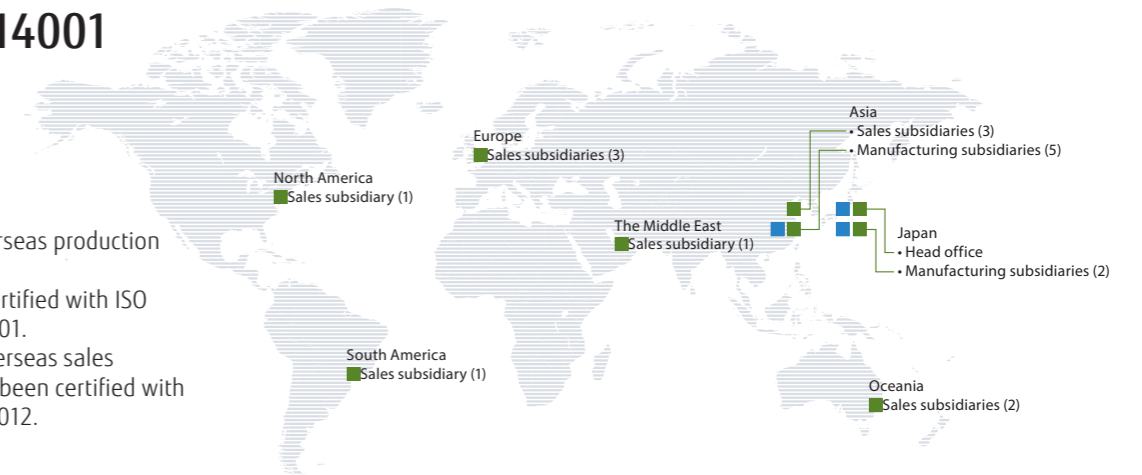

Product Quality Assurance

All Fujitsu General plants are ISO 9001 certified and operate under a unified quality control system. We deliver to customers all over the world high-quality products that have passed stringent quality inspections.

Receiving inspection

We require all our parts suppliers to submit test reports to ensure that all parts we receive from them meet our quality standards. Our in-house test department inspects incoming parts to ensure their compliance with RoHS as required by the EU. We also conduct 100% inspection of main parts to prevent defective parts from making it to assembly lines.

Quality inspection of products

We carry out stringent quality inspections in all production processes performed in our plants. To keep the quality of our products high, inspectors check their quality from start to finish on production lines.

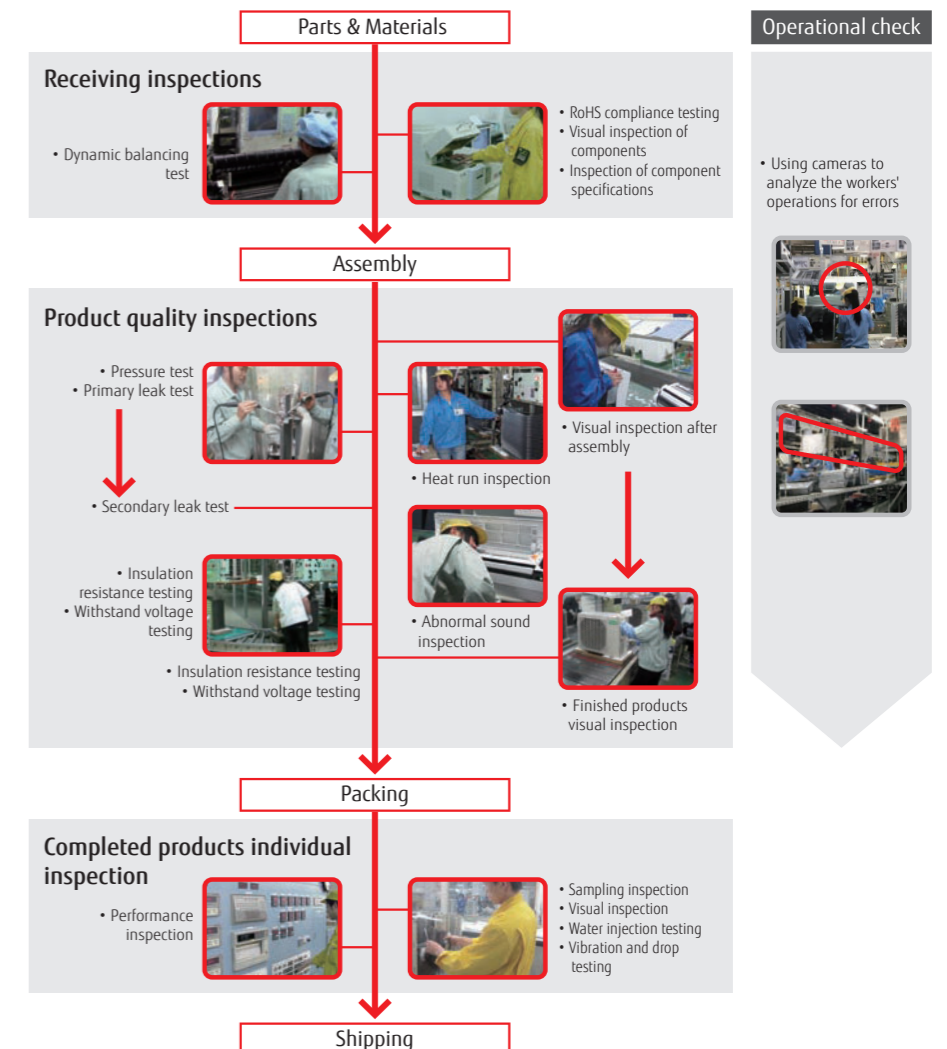



Multi-split indoor unit
Wall-mounted type Standard Series
High-efficiency for large rooms
24,000 BTU

2021 New Products



Floor type

Compact & Comfort

S-046

- 9/12/14 classes, 3 models
- High-efficiency
- New WLAN adapter (option)
- R32 refrigerant & low refrigerant volume



2-unit to 5-unit Multi-split type Indoor units

M-011, 022, 023

Wall-mounted type Standard Series

- 3 models
- Capacity range from 18,000 to 24,000 BTU

Floor type

- 3 models
- Capacity range from 9,000 to 14,000 BTU

Ceiling type

- 2 models
- Capacity range from 18,000 to 22,000 BTU

Medium static pressure duct

- Capacity range is 22,000 BTU



Multi-split type 3-unit, 4-unit, 5-unit

M-010-013

- 18-36 classes, 4 models
- Outstanding energy-saving performance
- R32 refrigerant & low refrigerant volume
- Slim and compact design
- Flexible installation





AIRSTAGE Indoor unit
Cassette type One-way flow Series

- V-062
- 7 models
 - Capacity range from 1.1 kW to 7.1 kW classes
 - Compact chassis size
 - Wide airflow range
 - Low noise operation



CONTROL SYSTEM

MODBUS® interface

- C-016
- Small, compact, and easy to install on DIN rails.
 - No separate external power supply required.
 - Modbus® interface enables central monitoring and control of air conditioners from BMS.



KNX® interface

- C-017
- Simple installation due to compact size.
 - No separate external power supply required (only KNX bus power required)



WLAN adapter

- C-018
- This interface provides the most advanced solution for the remote management of an air conditioning system by using smartphones, tablet PCs, and computers.

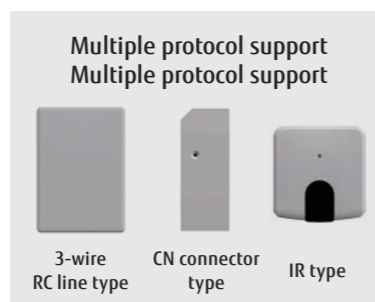

BACnet® gateway

- C-020
- BACnet® gateway connects BMS and a Fujitsu General split/multi-split/VRF system.



BACnet®/MODBUS® Router & Cloud device

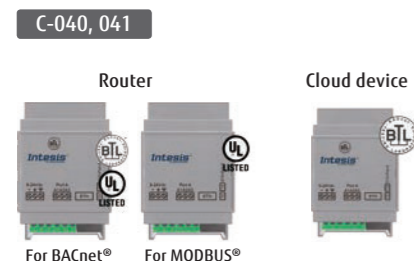

Multiple protocol LAN adapter



Pressure sensor kit



External power supply unit



WATERSTAGE
Split type & Split DHW Integrated type
Comfort Series 10 kW class

- W-012, 018
- 10 kW class, 1 outdoor unit
 - Advanced heating capabilities at low outdoor temperature
 - Enhanced anti-freezing functions in cold regions
 - Compact and quiet design to reduce noise during nighttime operation

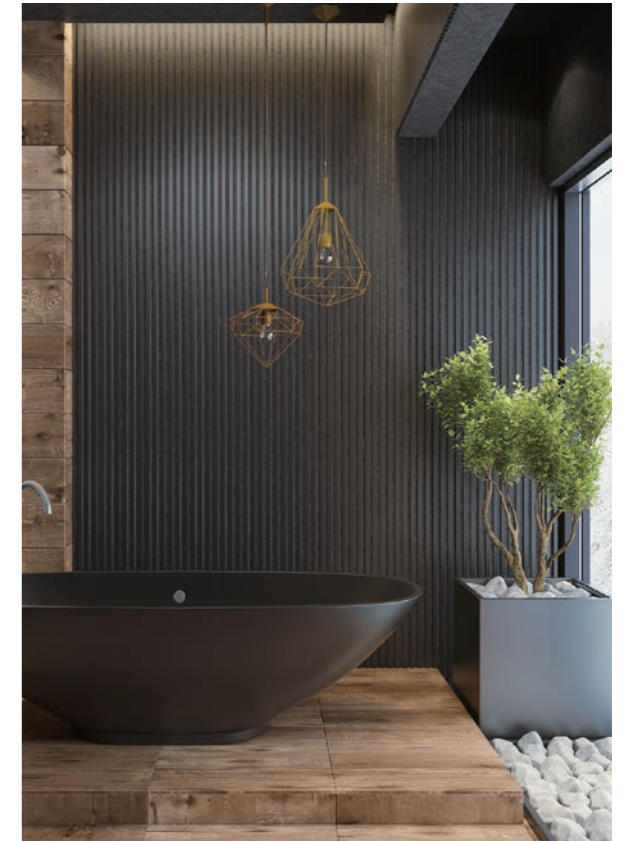

From Business to private spaces
SOLUTIONS

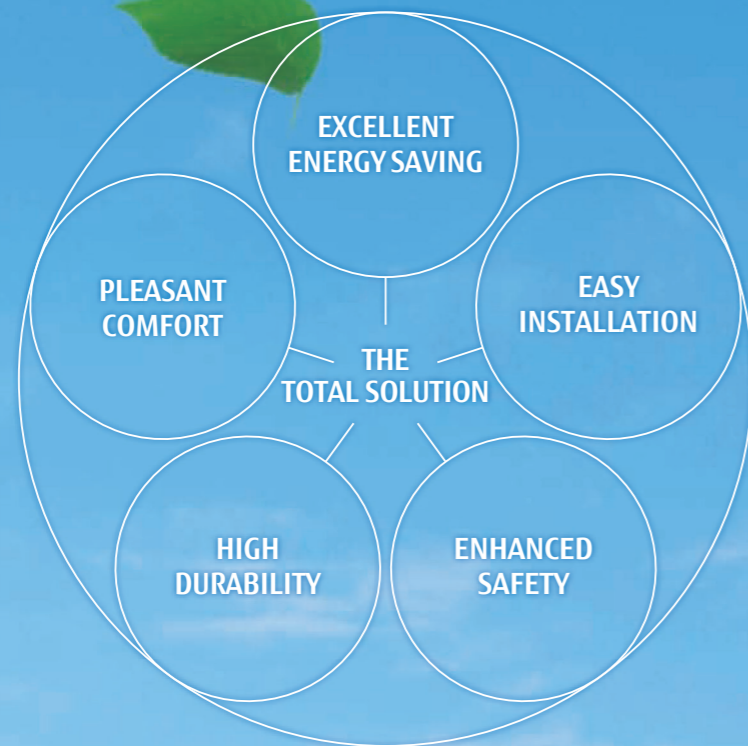

Key solution points

Fujitsu General's total solutions are tailored to each property's unique needs.

Fujitsu General provides the best control solutions for buildings.

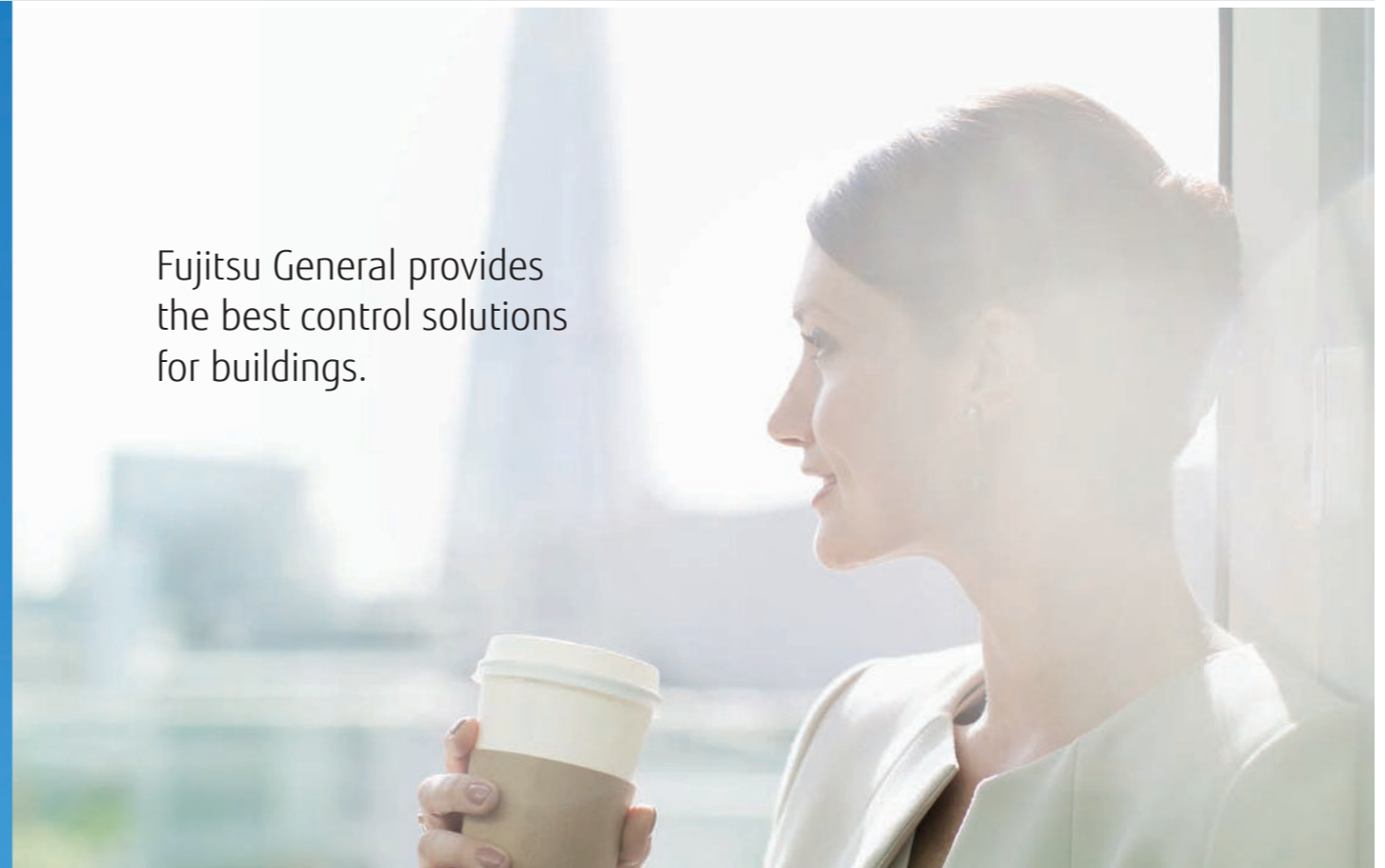

Target buildings

- A casual conversation with a colleague at work
- A presentation in a large meeting room
- A restaurant you stop by Your living room

We have a comprehensive lineup of air conditioners ideal for all these situations—from business to private spaces. Fujitsu General's air conditioners are used in all aspects of everyday life.



For Light commercial use

Comfortable and economical air conditioning systems, ideal for small and midsize commercial buildings

- 034 Shops and Restaurants
- 036 Small offices
- 038 Hotels
- 040 Schools



For Commercial use

Single and modular VRF systems for high efficiency, comfort, design flexibility, ease of installation, and high reliability

- 042 Large Buildings



For Residences

Smart air conditioning systems with extensive control options for comfort and convenience of use

- 044 Residences

Restaurant, shops

For Light commercial use

Fujitsu General provides perfect total air conditioning systems that offer seamless support by tenant, by purpose, and by customer visit frequency in shops and restaurants with multiple lighting and a high density of customers.



Single split

For Restaurants

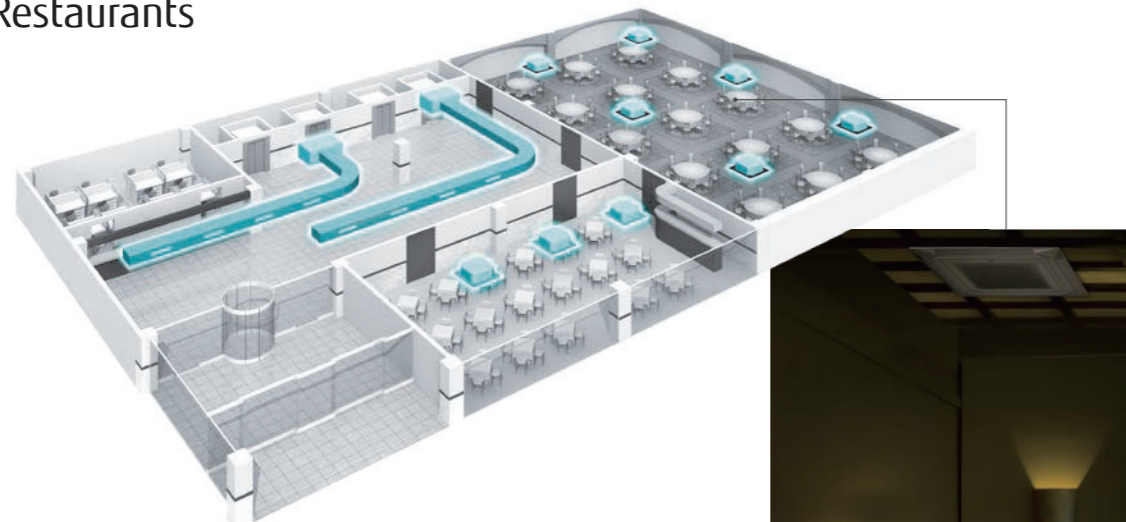

R32 large model lineup expanded

Expanded lineup of ceiling, cassette, and duct types suitable for large spaces using environmentally friendly R32 refrigerant

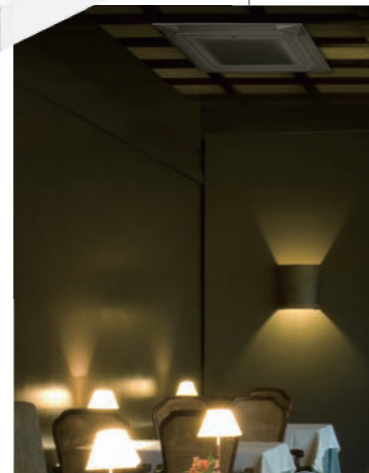

Circular flow cassette Series
For ambience with dimmed lighting

For rooms with bright interiors

Two panel colors

Both black and white panels are available for Cassette type. Black panels are suitable for dark places such as atmospheric restaurants. White panels, by contrast, are more appropriate for use in brightly lit spaces such as offices. (Available for Single split and VRF indoor units)

Simultaneous multi-split

For Shops

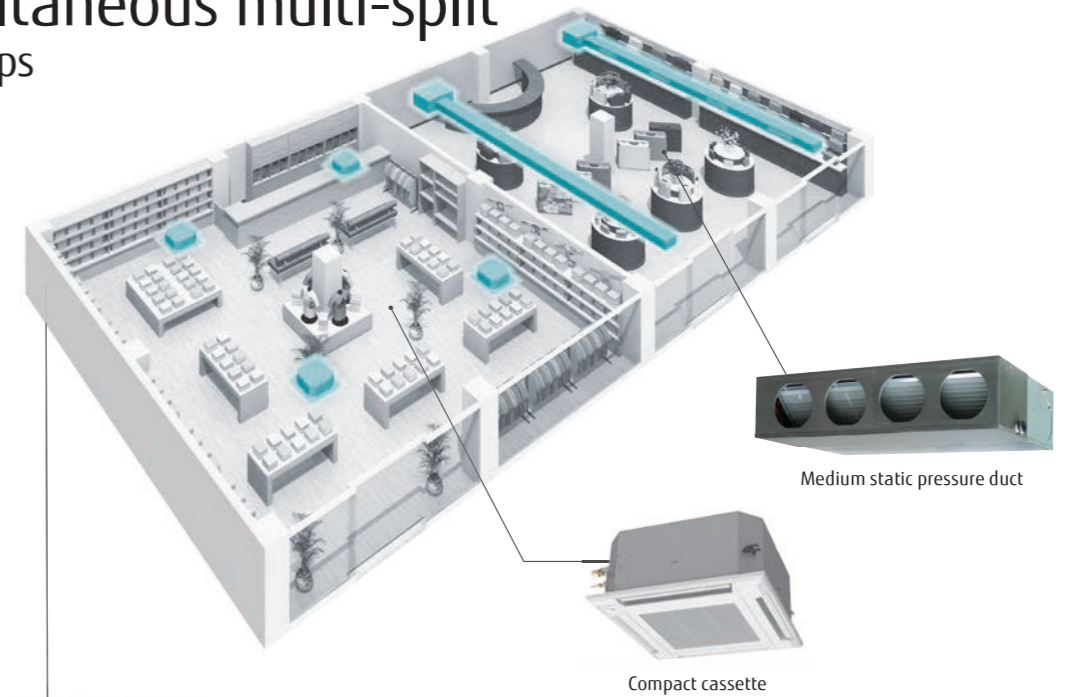

Small, lightweight outdoor unit

Models equipped with the new R32 refrigerant Compared to current models, the outdoor unit is more compact and easier to install. (45/54 models)
Compact cassette Series for grid ceiling were added to the lineup of indoor units to improve ease of installation.

Various indoor unit lineup

You can choose from 3 types of indoor units to suit the atmosphere and layout of your shop.

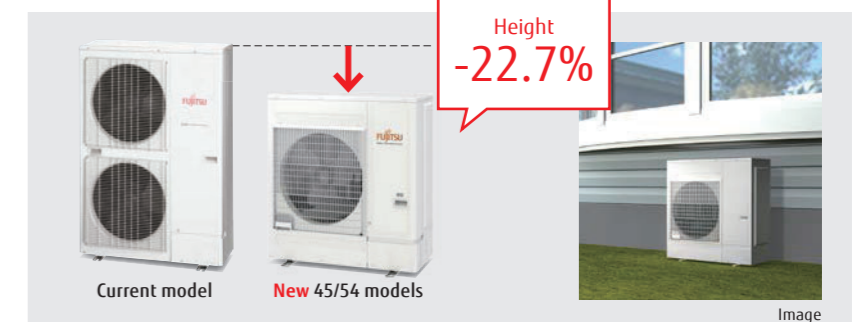

Small offices

For Light commercial use

Fujitsu General offers a perfect total air conditioning system for small office buildings with multiple small rooms, taking into consideration energy savings, low noise, comfortable air volume, usage and purpose, and centralized control.

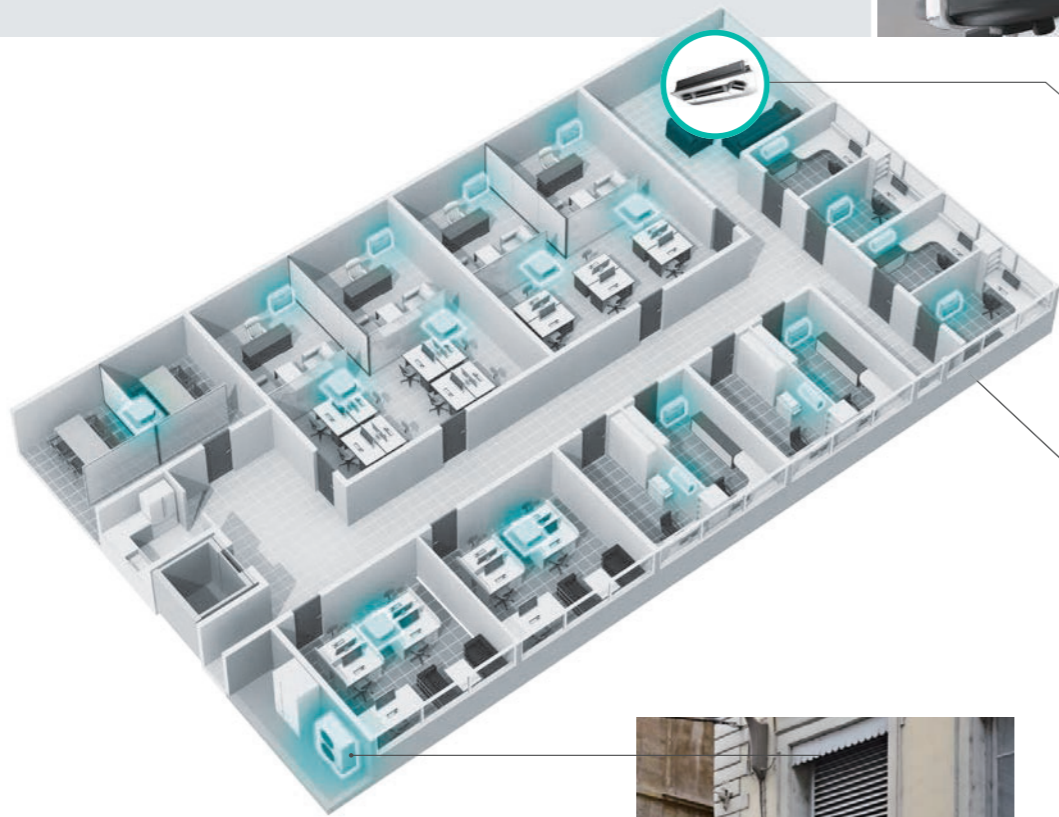

AIRSTAGE™ J Series compact outdoor units with up to 18 HP

Suitable for the buildings with multiple small rooms. Up to 42 indoor units* can be connected.

*Only J-IVL Series 18 HP model

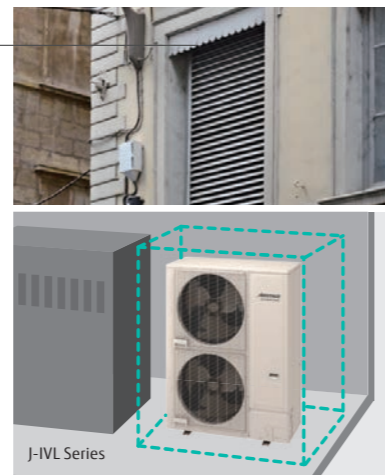

Compact outdoor unit with low noise design

Takes up little space even when installed in a machine room or on the roof. Sufficient static pressure can be maintained even with louvers. Low-noise mode suffices even for nighttime operations at low noise levels.

Breakthrough 3D flow cassette with innovative pursuit of comfort

The left and right air outlet ports with a maximum rotation angle of 100° and the wide central air outlet port create a comfortable space with less uneven temperature.



Wide lineup of indoor units of low-capacity class

Various low-capacity 1.1 kW indoor units are available for small rooms and spaces.

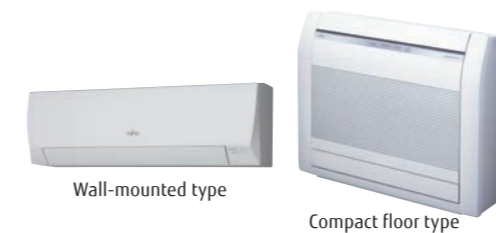

Central remote controller UTY-DCGY22



Central remote controller with improved operability

Controls the temperature of each room easily, and manages and sets the operation control for a week. Energy-saving management by setting upper and lower temperature limits and operating prohibitions.

LAN



Computer

Control and monitoring

You can operate the main unit from your desk. Non-administrators can also operate the air conditioners with a Computer, smartphone or tablet PC.



Router



Tablet PC

Smartphone

Static IP address and IP forwarding to open ports required

*Wireless LAN will be supported in the future.

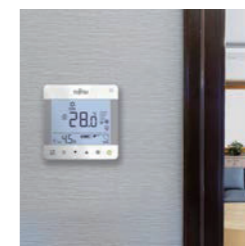

Compact wired remote controller

Compact size with a large screen for easy operation. The stylish design harmonizes with the interior.

Hotels

For Light commercial use

Fujitsu General offers total air conditioning systems perfect for low-rise, small hotels that take into account energy savings, external appearance, safety, and ease of installation.

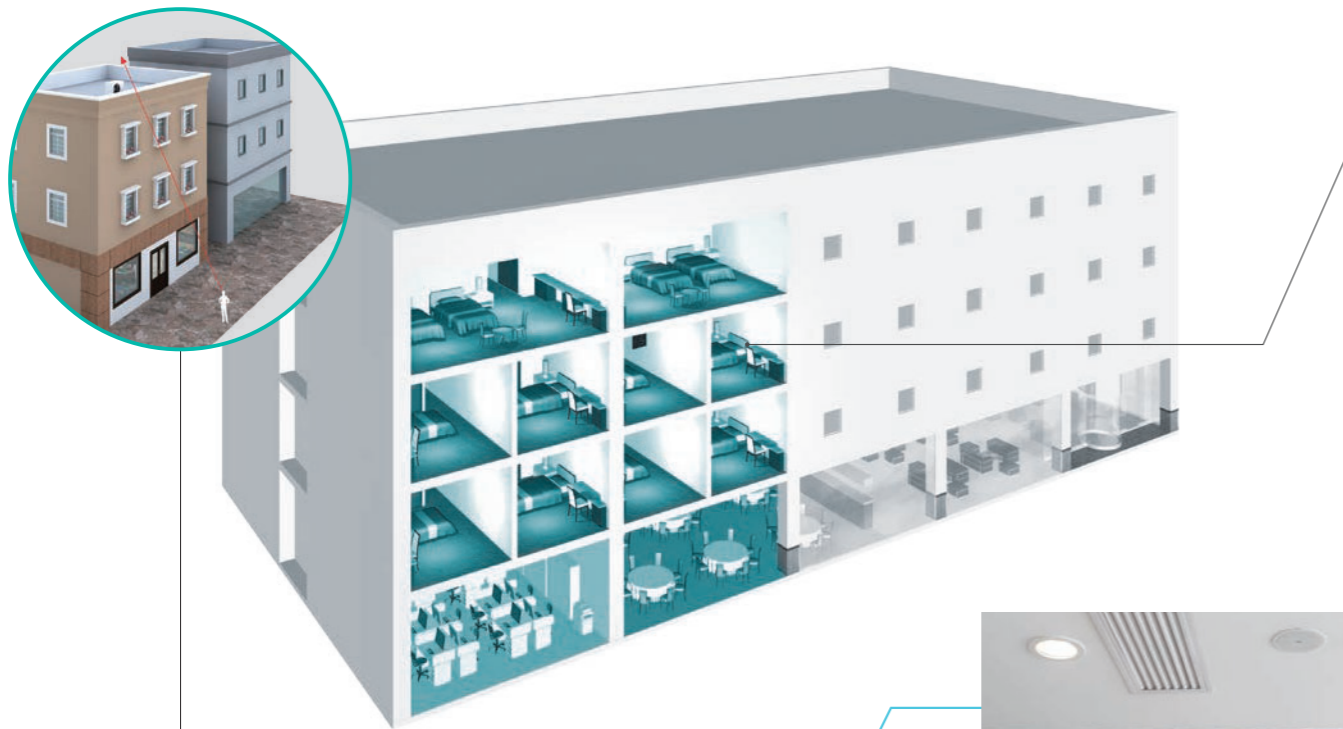

AIRSTAGE™ J Series compact outdoor unit with appearance-conscious design

The class-leading compact design will not detract from the appearance of the hotel.

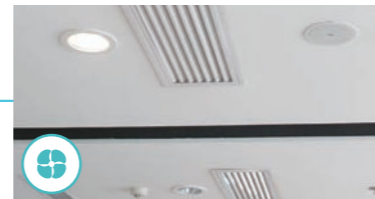

Supports ventilation for the entire hotel

Outdoor air processing is essential in an airtight hotel space. The DX kit links up with air conditioners to ensure sufficient ventilation. The system is expandable.

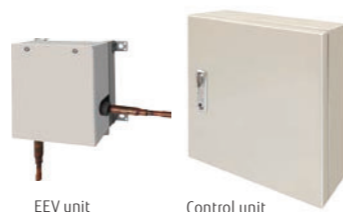

Guest room air conditioning with superior comfort, energy efficiency, and ease of installation

Space saving
Mini duct type with a height of 198 mm and a depth of 450 mm. Easily installed in a narrow ceiling space.

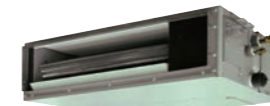

Mini duct



Card key switch available
Linked to a card key to prevent people from forgetting to turn off the air conditioner.



External connection switch



Comfortable airflow by switching the up/down airflow direction
The Auto louver grille kit creates comfortable airflow by adjusting the air direction.

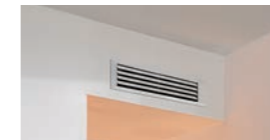

Auto louver grille kit

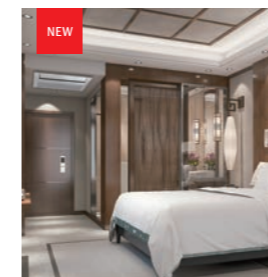

One-way flow cassette Series

Compact chassis with low noise operation
The low operating noise makes the model ideal for use in hotel rooms.



Centralized control of air conditioning for shared spaces

Lobbies, hallways, and other common spaces are centrally controlled for air conditioning. Temperature and operating conditions can be managed without any adjustments by the guests.



System controller

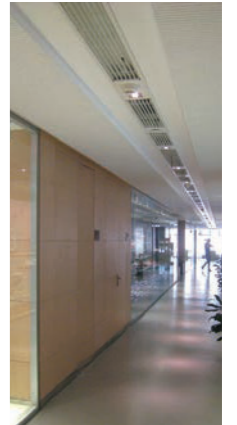

Simple remote controller with sophisticated design

The ease of operation makes it an ideal choice for use in hotels or offices. Simple buttons and a white backlit large LCD screen make it easy to operate in the dark.



Large space air conditioning for the reception area and lobby

Duct type Big duct Series suitable for large spaces with high ceilings



Schools

For Light commercial use

Fujitsu General offers indoor units that allow multiple connections with a compact design that reduces the installation area and increases the flexibility for selecting installation locations, making them perfect for midsize educational institutions. One single outdoor unit is able to cover an entire school building.

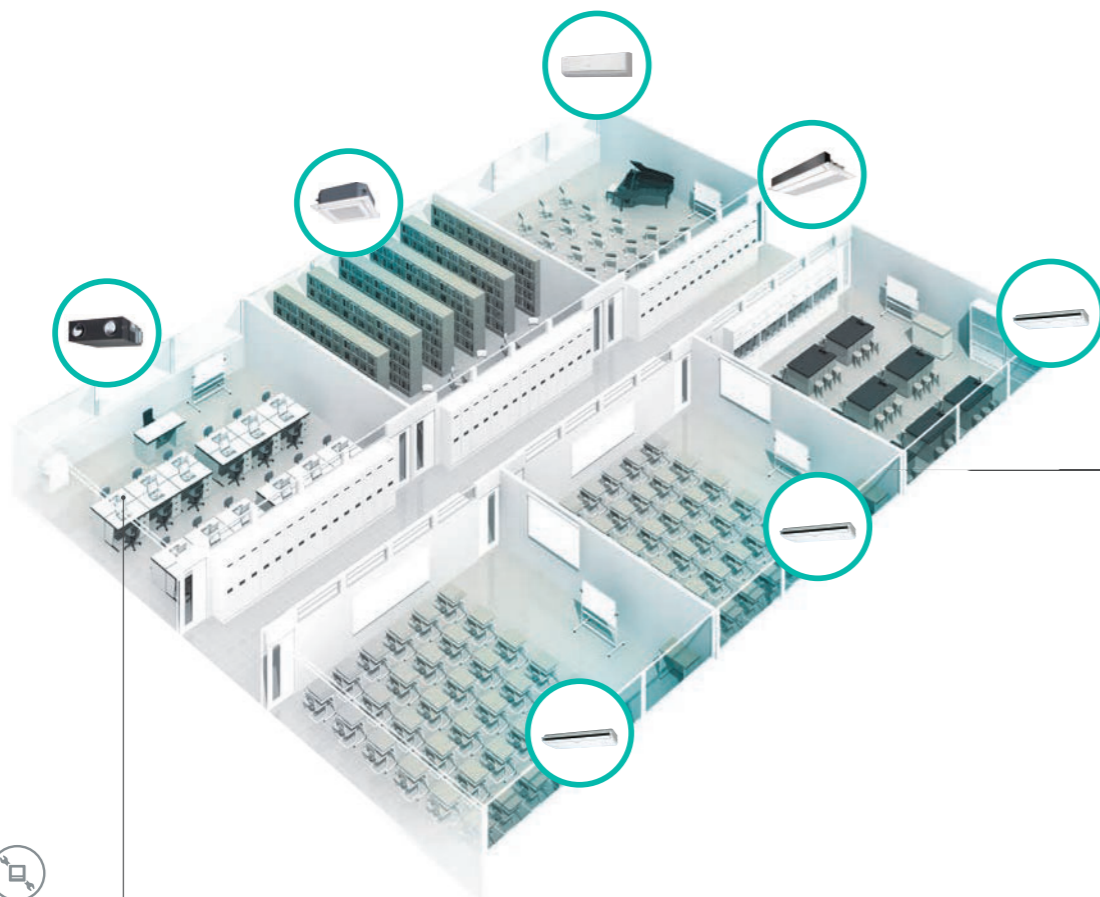

Centralized control of both air conditioning and ventilation equipment

Centralized control is also possible to stop the operation of not only air conditioners but also lighting and ventilation equipment. These features are useful for managing the energy efficiency of the entire building.

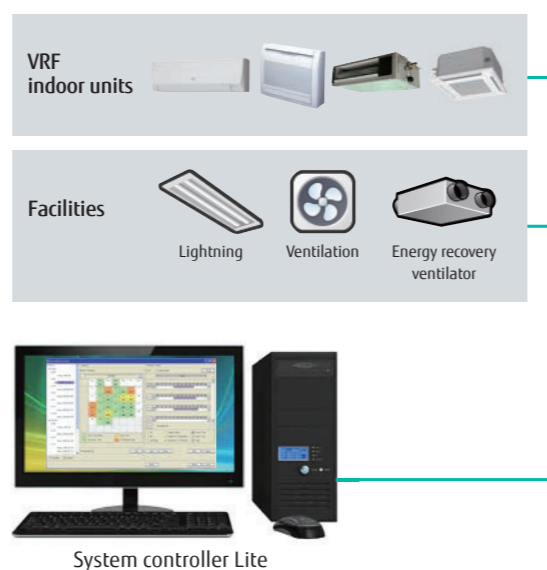

Wide variety of indoor units

Support complex applications for regular classrooms, special classrooms and auditoriums. Ventilators can also be added easily.

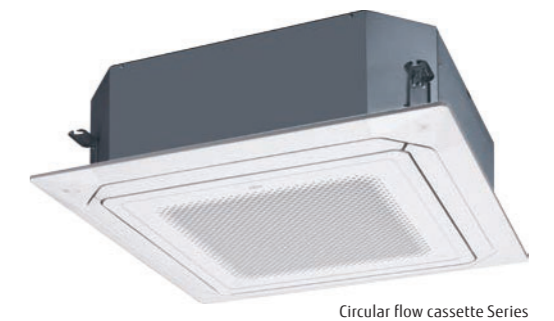
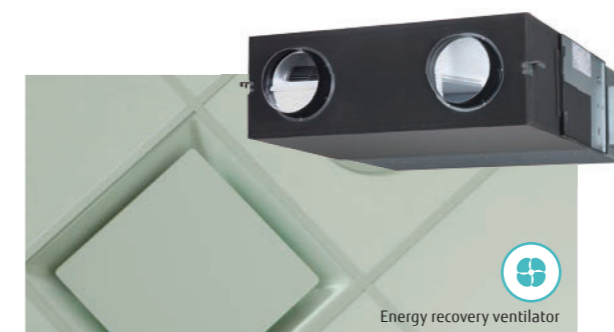

Comfortable room air conditioning without airflow sensation

Circular flow cassette blows air in all directions at a uniform temperature.



Individual airflow direction control to prevent people from being exposed to airflow

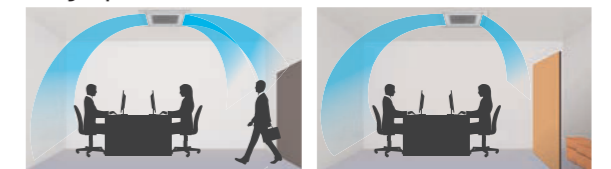

Energy-saving operation when unattended, in conjunction with a human sensor.

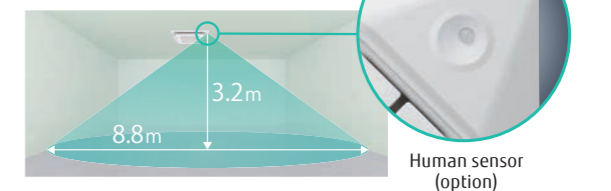



Large buildings

For Commercial use

Fujitsu General offers modular VRF systems that pursue high efficiency, comfort, design flexibility, ease of installation, and reliability for high-rise buildings.



Abundant lineup optimized for the operating environment

The VRF system meets a variety of needs, including energy-saving models and models with compatibility to outdoor temperatures of up to 52°C*.

*: V-III Tropical Series only



AIRSTAGE™ VR-IV

Smart, cutting-edge design Extensive lineup from 10 HP to 48 HP with the capacity ratio of indoor units connectable up to 150%.

25 models with 10 to 48 HP

- Space saving combination: 19 models from 10 to 48 HP
- Energy efficient combination: 6 models from 30 to 44 HP



39 models from 8 to 54 HP

- Space saving combination: 24 models from 10 to 54 HP
- Energy efficient combination: 15 models from 16 to 46 HP

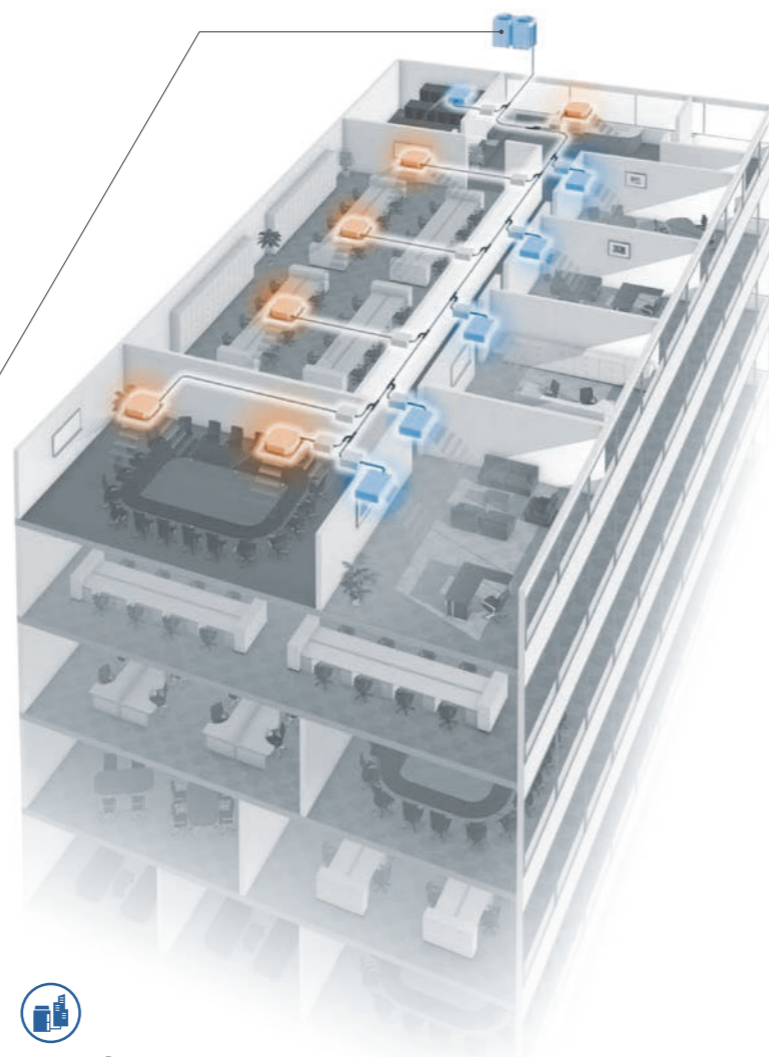

Height difference up to 110 m

The height difference between the outdoor unit and the indoor unit is normally 50 m for the V-III Series, but can be extended to 110 m by installing the Pressure sensor kit.

* Can only be connected to the V-III Series



Centralized control

Not only indoor units in the building, but also facilities such as ventilation can be controlled easily by anyone



System controller (UTY-APGXZ1)
System controller Lite (UTY-ALGXZ1 & UTY-PLGXX2)



Linkage with various BMS

Linking with MODBUS®, BACnet®, KNX® and other interfaces allows centralized control of equipment other than air conditioning.

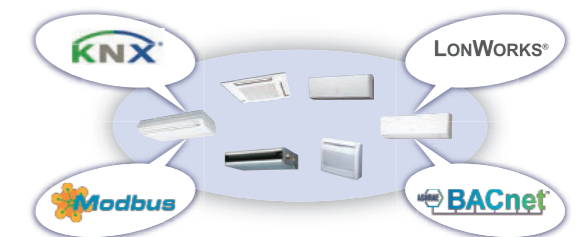

High system flexibility

The industry-leading high static pressure, long pipe design, and connection capacity enable flexible installation on each floor and installation of various indoor units.

82* Pa
*: V-III Series, 80Pa for VR-IV Series

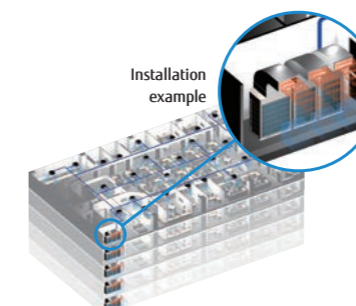
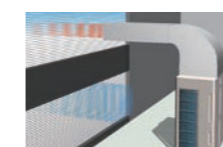

Prompt service support

Web monitoring tool and System controller remotely monitor the air conditioning of the entire building. Self-diagnosis in cooperation with the management company enables quick response in case of an emergency.

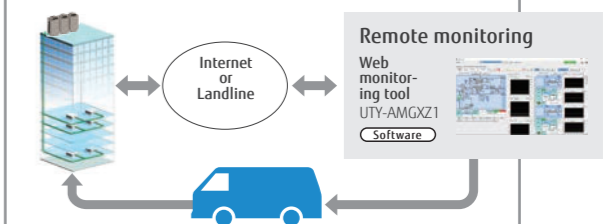

Residences

For Apartments & Houses

From the living room, where the whole family relaxes, to bedrooms, children's rooms and other small rooms, Fujitsu General has designed systems suited to spaces that reflect the rhythm of life.



 **A variety of indoor units to suit the characteristics of each room**



For Living & Dining room

Cool beauty design Series
This series features a special European-style design. The light, elegant and three-dimensional expression achieved by the curved surface is beautiful from all angles.

KE Series



KM Series

For Large rooms

Standard & Comfort Series
The basic functions and powerful, comfortable airflow volume controls are optimal for large spaces.



KP Series

For Primary bedrooms or Living rooms

Good Design Award winning, Quietet Series
High performance, low noise with emphasis on design



KM Series GOOD DESIGN

For Bedrooms or Home offices

Standard & ECO Range Series
High performance and compact design suitable for bedrooms, home offices and other small spaces



Outdoor units suitable for residential environments

 **R32 Multi-split type released**

Models are now available with environment-friendly R32 refrigerant. A number of products with improved external design have been added to the indoor unit lineup.

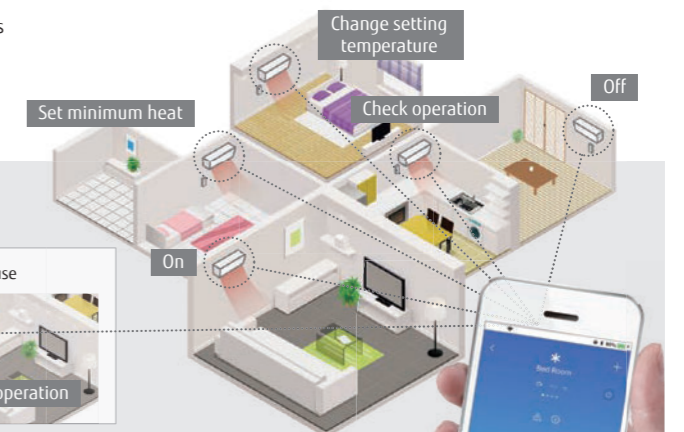
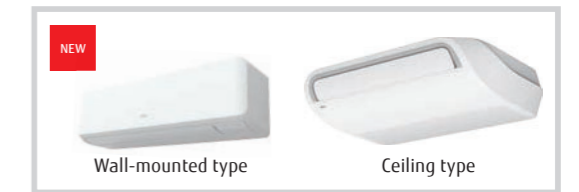

 **Operation from anywhere**

With a single smartphone, you can check the operating status of not only your home air conditioner, but also the air conditioners in your second house or in your parents' house (up to 24 air conditioners).



With the WLAN adapter and the FGLair app, you can control the heating and cooling of your home anytime, anywhere.

Light Commercial & Residential SPLIT & MULTI-SPLIT

Energy saving design to provide a comfortable indoor environment while being environment-friendly.

These are air conditioners that are both user-friendly and environment-friendly. Fujitsu General air conditioners cater to a wide range of needs, from living rooms, bedrooms, stores, small offices, through to hotels.

SPLIT

- Refrigerant R32 models
 - Wall-mounted type
 - Cassette
 - Duct
 - Floor
 - Ceiling
- Refrigerant R410A models
 - Duct

MULTI-SPLIT

- Refrigerant R32 models
 - 2-unit to 5-unit Multi-split
 - Simultaneous Multi-split Twin/Triple
- Refrigerant R410A models
 - 6-unit to 8-unit Multi-split
 - Simultaneous Multi-split Twin/Triple/Double Twin



SPLIT & MULTI-SPLIT

Light Commercial &
Residential



Light Commercial & Residential SPLIT

- S-004 Split Overview
- S-006 Indoor Units Lineup
- S-008 Features
- S-013 Features Explanation
- S-050 ECO Series Lineup Specifications
- S-054 Feature Summary



Refrigerant R32 models

Wall-mounted type

- S-014 Flagship Series
- S-016 Designer Series
 - High Spec & Design
 - Cool Beauty Design
- S-020 Standard Series
 - High-Efficiency
 - High-Efficiency for Large Rooms
- S-026 ECO Series
 - Compact & Comfort
 - Comfort for Large Rooms

Cassette

- S-030 Compact 4-way Flow Series – Compact Size
- S-032 Circular Flow Series – Comfort for Large Rooms

Duct

- S-034 Slim Duct – Slim Design
- S-036 Medium Static Pressure Duct – Compact & Comfort
- S-038 Medium Static Pressure Duct – Standard
- S-040 High Static Pressure Duct

Floor, Ceiling

- S-046 Floor – Compact & Comfort
- S-048 Ceiling



Refrigerant R410A models

Duct

- S-042 High Static Pressure Duct
- S-044 Big Duct



Split Overview

Fujitsu General provides its customers with 6 types and 128 models of air conditioning systems perfect for various customer applications and layouts. Added to this lineup recently are the environment-friendly R32 refrigerant models.



Wall-mounted type, Designer Series, Cool Beauty Design



Ceiling



Wall-mounted type

Simple and easy to install, all models, including the flagship model equipped with dual-fan, are expertly designed to control airflow and save energy. The design, with its flat and simple appeal, perfectly matches room interiors. Many of the models in the lineup adopt the new environmentally friendly R32 refrigerant.



Duct

The main unit is hidden in the wall, making the room look neat and tidy. Mini Duct and Slim Duct models are also available for installation in narrow spaces between beams or above the ceiling. Large models, suitable for air conditioning vast spaces, allow multiple outlets to be installed in just one unit, and are perfect for atypical room layouts.



Cassette

The Cassette type, which blends in perfectly with the interior design, blows air in all four directions to create an even air-conditioning for the entire space. We have a variety of series including Compact models with a uniquely designed panel to match grid ceilings, and Circular Flow models that send airflow in a 360° direction.



Floor

The compact and slim design makes this model suitable for installation in commercial as well as residential buildings. This model is also recommended as a heating device because it delivers a warm airflow from both the top and bottom outlets.



Ceiling

As with the wall-mounted unit, ceiling installation is very easy, and the unit's thin structure with a height of just 240 mm allows neat installation. The powerful airflow that can reach far away from the wide outlet is perfect for large meeting rooms, audiovisual rooms, and other rectangular spaces with a lot of depth.

Indoor Units Lineup



FUJITSU GENERAL (Euro) GmbH participates in the ECP program for VRF. Check ongoing validity of certificate: www.eurovent-certification.com *Models so marked are not ECC certified.

Type	Series	Refrigerant	Model	Class				Class										
				7	9	12	14	18	22	24	30	36	45	54	60	72	90	
Wall-mounted type	Flagship Series nocria X					ASYG12KXCA												
	Designer Series High Spec & Design			ASYG07KGTB	ASYG09KGTB	ASYG12KGTB	ASYG14KGTB											
	Designer Series Cool Beauty Design			ASYG07KETA ASYG07KETA-B	ASYG09KETA ASYG09KETA-B	ASYG12KETA ASYG12KETA-B	ASYG14KETA ASYG14KETA-B											
	Standard Series High-Efficiency & Comfort			ASYG07KMCC	ASYG09KMCC	ASYG12KMCC	ASYG14KMCC											
	Standard Series High-Efficiency & Large Rooms							ASYG18KMTB		ASYG24KMTB								
	Standard Series High-Efficiency & Large Rooms										ASYG30KMTA	ASYG36KMTA						
	ECO Series Compact Size			ASYG07KPCA	ASYG09KPCA	ASYG12KPCA												
	ECO Series Comfort for Large Rooms							ASYG18KLCA*		ASYG24KLCA*								
Cassette	Compact 4-way Flow Series Compact Size				AUXG09KVLA	AUXG12KVLA	AUXG14KVLA	AUXG18KVLA	AUXG22KVLA	AUXG24KVLA								
	Circular Flow Series Comfort for Large Rooms			18/22/24 30/36/45/54				AUXG18KRLB	AUXG22KRLB	AUXG24KRLB	AUXG30KRLB	AUXG36KRLB	AUXG45KRLB	AUXG54KRLB				
Duct	Slim Duct			09/12/14 18	ARXG09KLLAP	ARXG12KLLAP	ARXG14KLLAP	ARXG18KLLAP										
	Medium Static Pressure Duct Compact Size			12/14 18/22/24/30 36/45/54		ARXG12KHTAP	ARXG14KHTAP	ARXG18KHTAP	ARXG22KHTAP	ARXG24KHTAP	ARXG30KHTAP	ARXG36KHTAP	ARXG45KHTAP	ARXG54KHTAP				
	Medium Static Pressure Duct Standard								ARXG22KMLB	ARXG24KMLA	ARXG30KMLA	ARXG36KMLA	ARXG45KMLA					
	High Static Pressure Duct													ARXG45KHTA	ARXG54KHTA			
																ARYG60LHTA		
Big Duct																ARYG72LHTA*	ARYG90LHTA*	
Floor Compact & Comfort				AGYG09KVCA	AGYG12KVCA	AGYG14KVCA												
Ceiling			18/22 24/30 36/45/54					ABYG18KRTA	ABYG22KRTA	ABYG24KRTA	ABYG30KRTA	ABYG36KRTA	ABYG45KRTA	ABYG54KRTA				

Features

High-Efficiency

ALL DC All DC Inverter Technology



DC twin-rotary compressor

A high-efficiency 2-cylinder rotary compressor with a DC inverter optimizes the internal structure of the compressor to achieve higher energy efficiency compared to similar compressors.

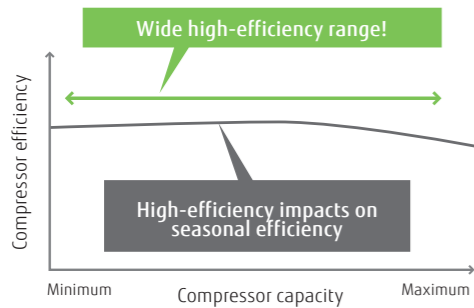

DC fan motor

The DC fan motor produces high power, a wide operating range, and high-efficiency.

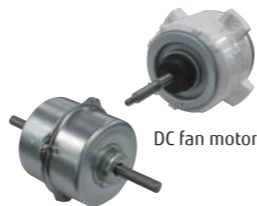

Sine-wave DC inverter control

High-efficiency operation is realized by using sine-wave DC inverter control.

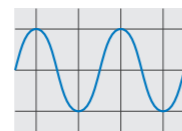

Heat Exchanger for Wall-mounted type

High-density multipath heat exchanger

Thinner and denser heat exchangers and multipath efficiency technology have substantially improved heat exchange performance.

High-performance sub-cool heat exchanger

A counter-type bypass circuit has been incorporated to achieve a higher performance. (Large multi-split type, VRF)

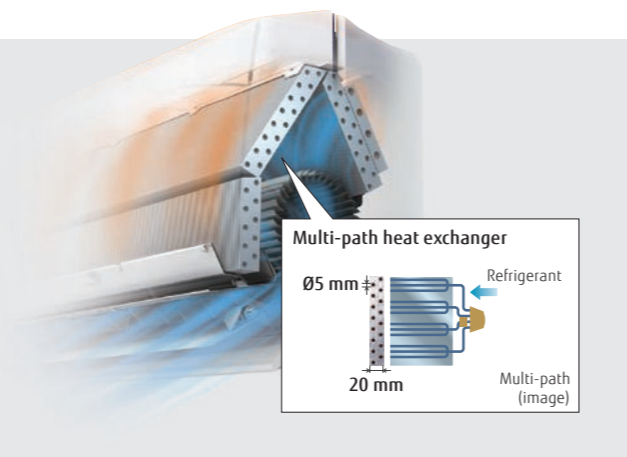

High Energy Saving

Human sensor control

The Human sensor monitors the movements of people in a room and operates the air conditioner at a lower capacity when people leave the room. When people come back to the room, it automatically returns to the previous operating mode.

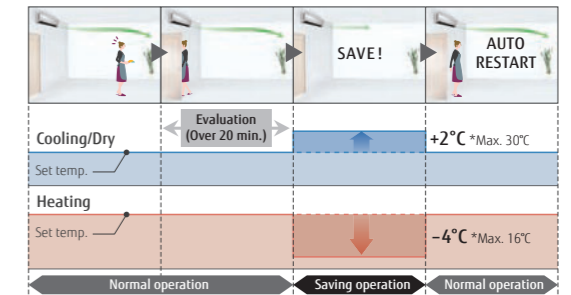

Economy operation

Limits maximum operation, reducing the power consumption, and thereby suppressing the maximum load.

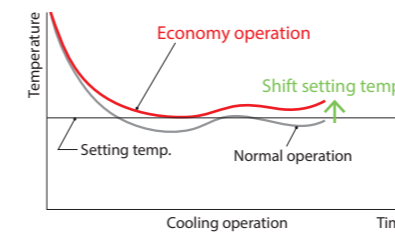

Setting temperature range limitation

The minimum and maximum temperature range can be set giving further energy savings while considering the comfort of the occupants.

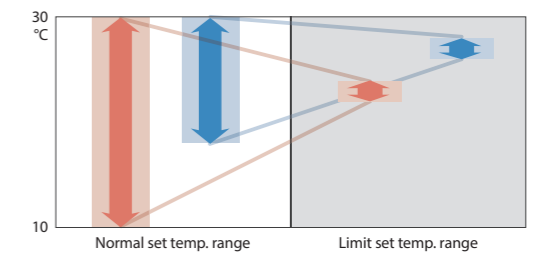

Set temperature auto return

- The set temperature automatically returns to the previously set temperature.
- The time range in which the set temperature can be changed is from 10 to 120 minutes.

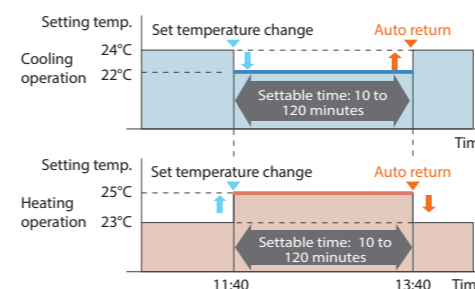

Auto-off timer

- The indoor unit is automatically turned off when it reaches a preset operating time frame.
- The time frame of the Auto-off timer can be flexibly scheduled.
- Auto-off times can be set from 30 to 240 minutes.

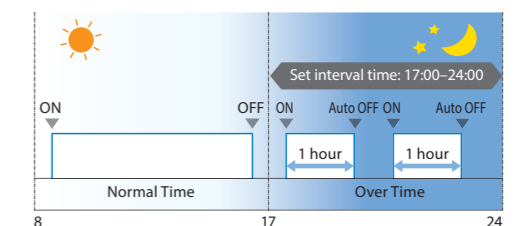

More Comfort

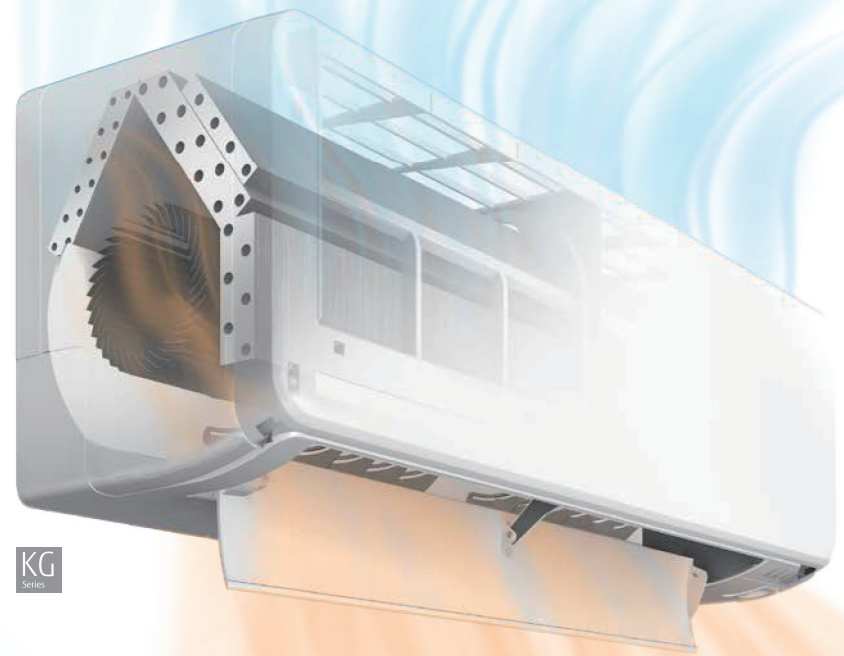

KG Series

Powerful heating

A large heat exchanger, a large DC rotary compressor, and a high-performance inverter PCB provide high heating capacity even at low outdoor temperature.

Power diffuser

These three technologies enable precise wind direction control and improve ventilation efficiency; our airflow control offers a more comfortable environment.

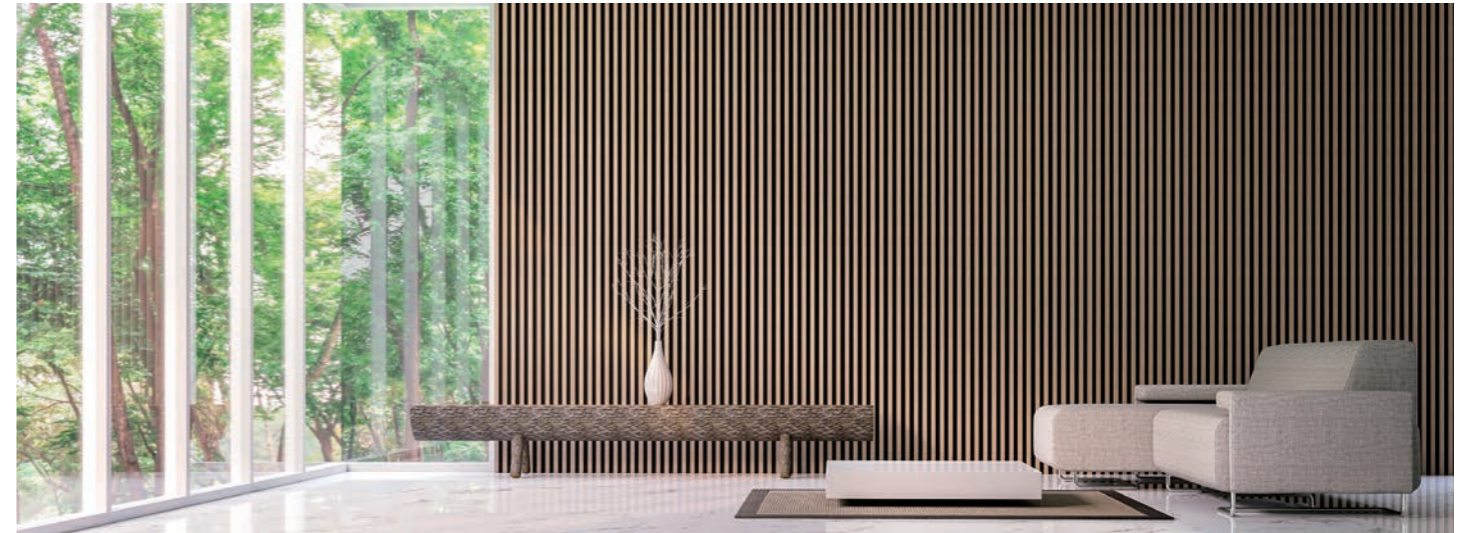
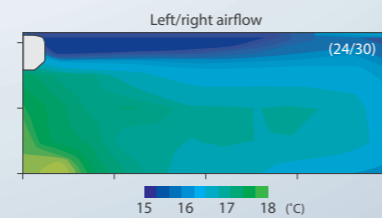
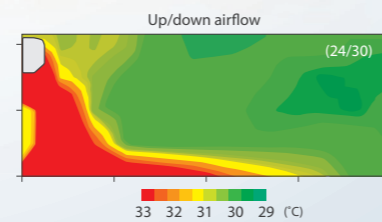

Powerful operation

Maximum airflow and maximum compressor speed are maintained for the period necessary to reach the set temperature quickly.

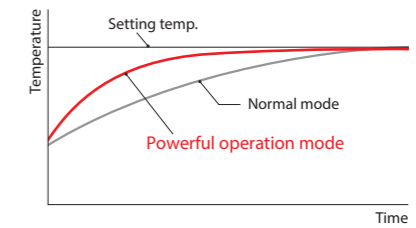

10°C Heat

After a person has left the room, the system switches to minimum heating operation to maintain the room temperature. (Maintained at 10°C)

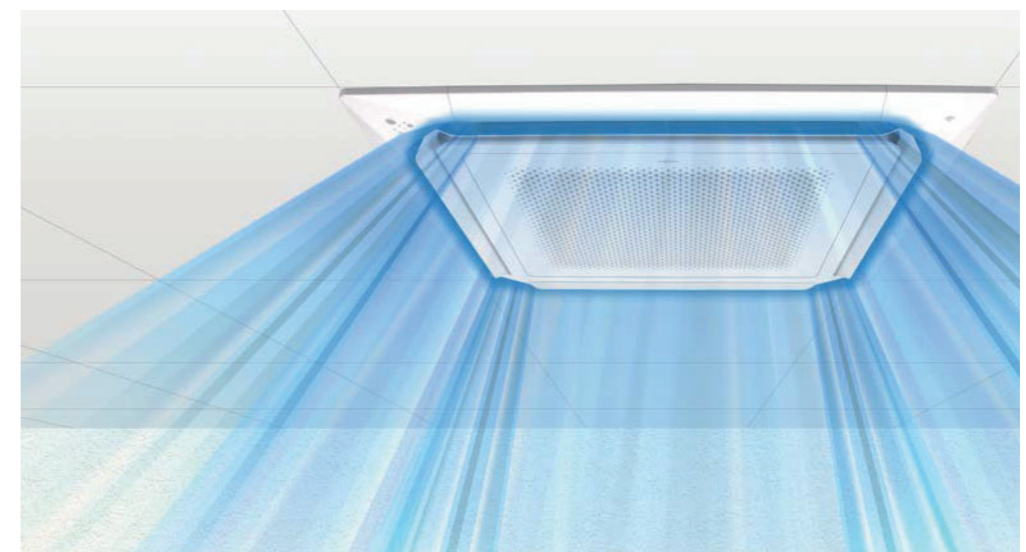
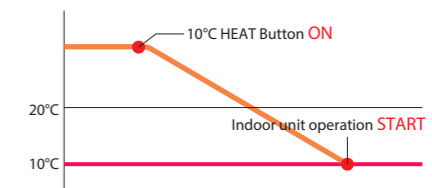

Uniform air conditioning

Circular airflow to achieve uniform air conditioning without temperature unevenness in workspaces



Quiet and Comfort Control



Low Noise Technology

Outdoor unit fan

Outdoor unit fan design with a small separation vortex, minimized air volume by fan control, and top-class low noise

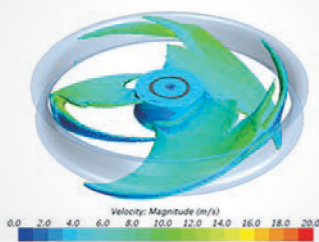

Air stabilizer in Duct

Low-noise duct structure with a built-in air stabilizer

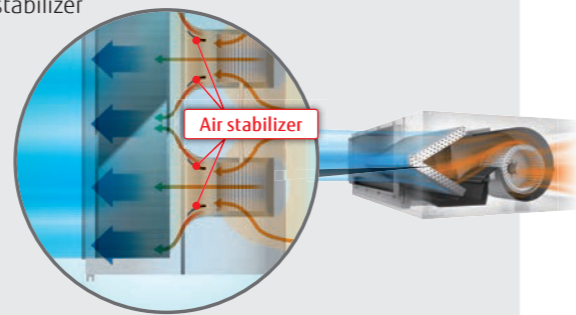

Outdoor unit low noise operation

Users can choose low noise levels, depending on the installation environment. Operation time can be set by timer.

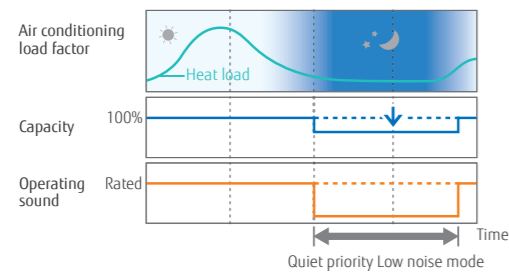

Auto changeover

In an auto setting, the system automatically switches between cooling and heating modes according to the set temperature and room temperature.

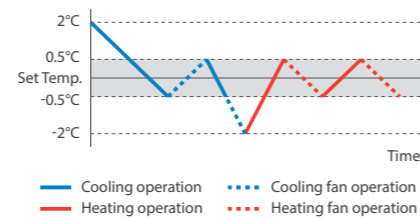

Fresh air intake for Cassette, Duct, Ceiling

Fresh air is taken in by a fan connected to an external control unit.



Feature Explanation

Energy-Saving Features

- Dual-fan**
Hybrid Airflow, which combines air currents of different temperatures and velocities, creates a comfortable space.
- Economy mode**
The thermostat setting is adjusted automatically according to the room temperature to avoid unnecessary cooling or heating.
- Save Human sensor**
The Human sensor detects the movement of people in the room and determines whether to switch to energy saving operation.
- Setting temperature range limitation**
Sets the minimum and maximum limits on room temperature to establish the right balance between energy saving and a comfortable environment.
- Human sensor for saving/stop modes**
The Human sensor (option) detects movement of people in the room and decides whether to save energy or stop the unit.
- Set temperature auto return**
The setting temperature automatically returns to the previously set temperature.

Features for Comfort

- Powerful heating**
Maintains the rated heating capacity even when the outdoor ambient temperature is -7°C.
- Powerful mode**
Operation at maximum air flow and compressor speed, that quickly makes the room comfortable.
- Auto changeover**
The unit automatically switches between heating and cooling modes based on the temperature setting and the room temperature.
- Automatic fan speed**
A micro-computer automatically adjusts the airflow to follow the changes in room temperature.
- Fresh air intake**
Fresh air can be taken in by a fan connected to an external control unit.
- Power diffuser**
An additional louver that opens based on input from monitoring sensors to quickly enhance immediate comfort needs.
- 10°C Heat**
The room temperature can be set to go no lower than 10°C, thus ensuring that the room does not get too cold when not occupied.
- UP/DOWN swing louver**
The vertical louver automatically swings up and down.
- Auto restart**
In the event of a temporary power failure, the air conditioner will automatically restart in the same operating mode as before, once the power supply is restored.
- Connectable distributing duct**
Locally purchased branch ducts can be attached to the systems to distribute the airflow.
- Server room operation**
Interlock operation is possible by connecting 2 indoor units even in low temperatures.
- Low noise mode**
The noise level of the outdoor unit can be selected.
- Double swing automatic**
Complex swing action of the louver enables automatic swing in both the left/right and up/down directions.
- Connectable fresh air duct**
Outside air can be introduced by attaching a locally purchased duct to the fresh air knockout and an optional part.
- Individual airflow direction control**
Each louver of a 4-way Cassette type can be controlled individually to provide comfortable airflow.

Convenience Features

- Auto-off timer**
Automatically stops operation when a fixed time has elapsed from the start of operation.
- Weekly timer**
Different ON-OFF times can be set for each day.
- External error output**
- External ON/OFF input**
- Sleep timer**
A micro-computer gradually changes the room temperature automatically to promote a comfortable night's sleep.
- Weekly & Temperature setback timer**
Weekly & Temperature setback timer can set the temperature for 2 time spans and for each day of the week.
- Program timer**
This digital timer allows selection of one of four options: ON, OFF, ON + OFF, or OFF + ON.
- Filter sign**
Indicates the filter cleaning period by blinking.
- Wireless LAN control**
The optional WLAN adapter enables the air conditioner to be operated by smartphone or tablet PC from outside the home.

Clean Features

- Plasma air clean**
The electrostatic precipitator removes dust particles such as pollen and house dust. It is washable and thus can always be kept clean.
- Apple-catechin filter**
The Apple-catechin filter uses static electricity to clean fine particles and dust from the air.
- Silver Ion Filter**
The Silver ion filter helps to keep indoor air free from viruses, bacteria and molds.
- Filter auto clean**
The dust collected by the air filter is automatically removed. A routine disposal of the dust stored in the dust box is necessary.
- Long-life filter**
- Ion deodorization filter**
The filter deodorizes by powerfully decomposing absorbed odors using the oxidizing and reducing effects of ions generated by an ultra-fine-particle ceramic.
- Washable panel**
Since the front panel is easy to remove, maintenance is also easy.

Installation

- Automatic airflow adjustment**
Automatically detects required airflow in each application case and adjusts the volume.
- Drain pump as standard**
- Blue fin**



All DC models

Wall-mounted type
Flagship Series

nocria™ X



Comfortable airflow control to prevent the body from being exposed to direct airflow



A comfortable space can be created with Hybrid Airflow, which combines different temperatures of air current and velocities.



*1: Announced 2012. In room air conditioner for the home (Our company's investigation)

Filter Auto Clean



Dust on the filter is automatically removed to prevent power from being wasted by the clogged filter.



*2: Announced 2002. In room air conditioner for the home (our company's investigation)

Plasma Air Clean

Air that passes through the indoor unit is cleaned by a built-in electrostatic dust collector. Pollen, house dust and other tiny pollutants are collected and removed with static electricity.



Human Sensor

The Human sensor detects movement of people in a room and operates at reduced capacity when people leave the room. When people return to the room, the system automatically returns to the previous room settings.

Rank A+++ SEER 8.5 SCOP 5.1

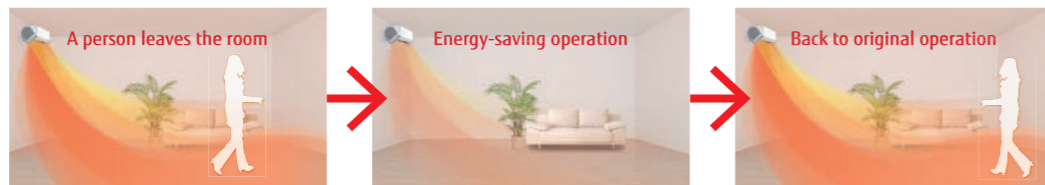

Model: ASYG12KXCA



Specifications

Model name	Indoor unit		Outdoor unit		ASYG12KXCA		AOYG12KXCA	
Power Source					Single phase, ~230 V, 50 Hz			
Capacity	Cooling		kW			3.4 (0.6-5.3)		
	Heating					5.0 (0.6-9.0)		
Input Power	Cooling/Heating		kW			0.670/1.020		
EER	Cooling		W/W			5.09		
COP	Heating					4.90		
Pdesign	Cooling/Heating (-10°C)		kW			3.4/3.5		
SEER	Cooling			W/W			8.50	
SCOP	Heating (Average)				5.10			
Energy Efficiency Class	Cooling				A+++			
	Heating (Average)				A+++			
Max. Operating Current	Cooling/Heating		A			9.0/16.0		
Annual Energy Consumption	Cooling		kWh/a			140		
	Heating					961		
Moisture Removal			l/h			1.2		
Sound Pressure Level	Indoor (Cooling)	H/M/L/Q	dB(A)			46/42/38/28		
	Indoor (Heating)	H/M/L/Q				48/43/39/30		
	Outdoor (Cooling/Heating)	High				44/43		
Sound Power Level	Indoor (Cooling/Heating)	High				58/62		
	Outdoor (Cooling/Heating)	High				57/57		
Airflow Rate	Indoor/Outdoor (Cooling)	High	m³/h			670/2,230		
	Indoor/Outdoor (Heating)					810/1,975		
Net Dimensions H x W x D	Indoor	mm			293 x 786 x 378			
	Outdoor	mm			704 x 820 x 315			
Weight	Indoor	kg (lbs)			20 (44)			
	Outdoor	kg (lbs)			41 (90)			
Connection Pipe Diameter (Liquid/Gas)			mm			6.35/9.52		
Drain Hose Diameter (I.D./O.D.)					11.8/15.0 to 16.8			
Max. Pipe Length (Pre-Charge)			m			15 (15)		
Max. Height Difference					10			
Operating Range	Cooling					-10 to 43		
	Heating					-15 to 24		
Refrigerant Charge	Type (Global Warming Potential)				R32 (675)			
			kg (CO2eq-T)			1.30 (0.878)		

Dimensions

(Unit: mm)

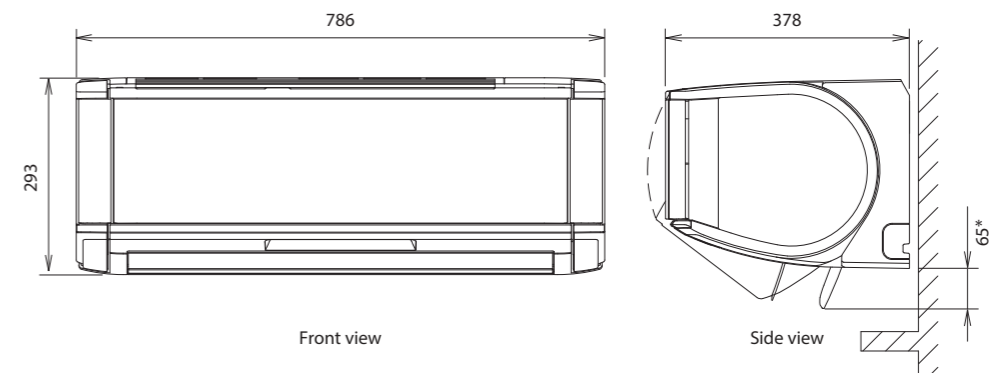

* Dimensions when air flowing downward

Wall-mounted type Designer Series High Spec & Design



High energy saving

High-efficiency has been achieved by the lambda heat exchanger, large cross-flow fan, and the new refrigerant.

Rank **A+++** SEER **8.5** SCOP **5.1**
*1: 07, 09, 12 models

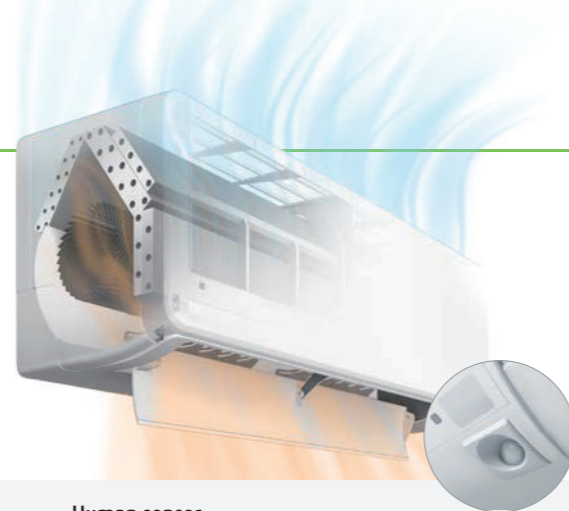

Hybrid-heat exchanger

The large hybrid heat exchanger has greatly improved the heat exchange efficiency to achieve top-level SEER and SCOP.

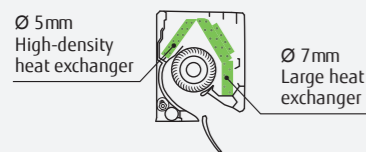

Ø107 Large cross-flow fan

The large-diameter fan generates air volume efficiently even at reduced power.

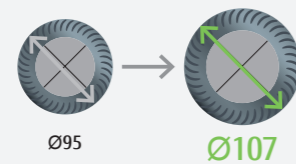

Human sensor

The Human sensor monitors the movements of people in a room and operates the air conditioner at a lower capacity when people leave the room. When people come back to the room, it automatically returns to the previous operating mode.

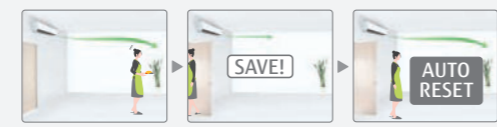

Comfortable airflow & Quiet operation

The large louver and the new air-blowing structure create a comfortable air flow that spreads all the way down to the user's feet with quiet operation.



Smart device control (Option)

Using a smartphone, tablet, or PC, you can easily control the air conditioner both inside and outside your home or office.



Model: ASYG07KGTB/ASYG09KGTB/ASYG12KGTB/ASYG14KGTB



Specifications

Model name	Indoor unit		ASYG07KGTB	ASYG09KGTB	ASYG12KGTB	ASYG14KGTB
	Outdoor unit		AOYG07KCCA	AOYG09KCCA	AOYG12KCCA	AOYG14KCCA
Power Source	Single phase, ~230 V, 50 Hz					
Capacity	Cooling	kW	2.0 (0.9-3.2)	2.5 (0.9-3.4)	3.4 (0.9-4.1)	4.2 (0.9-4.5)
	Heating	kW	2.5 (0.9-5.2)	2.8 (0.9-5.4)	4.0 (0.9-6.1)	5.4 (0.9-6.4)
Input Power	Cooling/Heating		0.400/0.500	0.555/0.560	0.805/0.910	1.175/1.350
EER	Cooling		5.00	4.50	4.22	3.57
COP	Heating		5.00	5.00	4.40	4.00
	Cooling/Heating (-10°C)		2.0/2.3	2.5/2.4	3.4/2.5	4.2/4.0
SEER	Cooling		8.52	8.52	8.51	7.11
SCOP	Heating (Average)		5.12	5.11	5.10	4.31
Energy Efficiency Class	Cooling		A+++	A+++	A+++	A++
	Heating (Average)		A+++	A+++	A+++	A+
Max. Operating Current	Cooling/Heating		6.5/9.0	6.5/9.0	6.5/9.0	9.0/10.5
Annual Energy Consumption	Cooling		82	103	140	207
	Heating		628	658	685	1,298
Moisture Removal			1.0	1.3	1.8	2.1
Sound Pressure Level	Indoor (Cooling)	H/M/L/Q	38/33/29/19	40/34/29/19	40/35/30/19	43/36/30/20
	Indoor (Heating)	H/M/L/Q	41/35/31/21	42/36/31/21	42/38/31/21	44/39/33/24
	Outdoor (Cooling/Heating)	High	46/46	46/48	50/50	50/50
Sound Power Level	Indoor (Cooling/Heating)	High	54/56	55/57	56/58	57/59
	Outdoor (Cooling/Heating)	High	61/62	61/63	65/66	65/66
	Airflow Rate	Indoor/Outdoor (Cooling)	High	650/1,610	700/1,610	700/1,680
Net Dimensions H x W x D	Indoor	mm	270 x 834 x 215	270 x 834 x 215	270 x 834 x 215	270 x 834 x 215
	Outdoor	mm	542 x 799 x 290	542 x 799 x 290	542 x 799 x 290	542 x 799 x 290
Weight	Indoor	kg (lbs)	10 (22)	10 (22)	10 (22)	10 (22)
	Outdoor	kg (lbs)	30 (66)	30 (66)	31 (68)	32 (71)
Connection Pipe Diameter (Liquid/Gas)			6.35/9.52			
Drain Hose Diameter (I.D./O.D.)			11.8/15.0 to 16.8			
Max. Pipe Length (Pre-Charge)			20 (15)			
Max. Height Difference			15			
Operating Range	Cooling		-10 to 46			
	Heating		-15 to 24			
Refrigerant	Type (Global Warming Potential)		R32 (675)			
	Charge	kg (CO2eq-T)	0.75 (0.506)	0.75 (0.506)	0.85 (0.574)	0.85 (0.574)

Optional parts

* For optional parts compatibility of Intesis devices, please refer to the optional parts compatibility list page C-046.

Compact wired remote controller:	UTY-RCRYZ1	External switch controller:	UTY-TERX	Network Converter for single split (DC power supply type):	UTY-VTGX
Wired remote controller (touch panel):	UTY-RNRYZ5	WLAN adapter:	UTY-TFSXW1	Network Converter for single split (AC power supply type):	UTY-VTGXV
Wired remote controller:	UTY-RLRY	Communication kit:	UTY-TWRXZ2	Silver Ion filter:	UTR-FA16-5
Simple remote controller (without operation mode):	UTY-RHRY	External input and output PCB:	UTY-XCSXZ2		
Simple remote controller:	UTY-RSRY	External connect kit:	UTY-XWZX		

Dimensions

(Unit: mm)

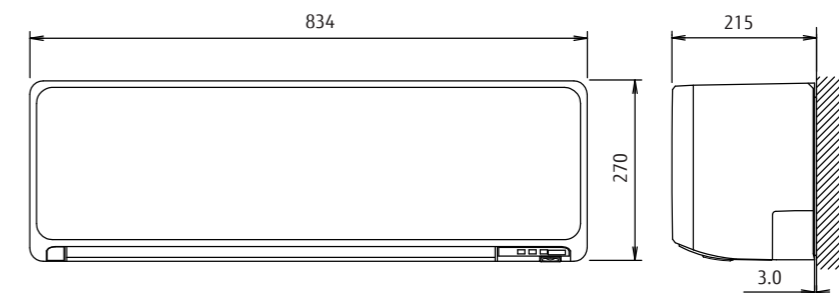

Wall-mounted type Designer Series Cool Beauty Design



Cool Beauty Design

We have designed this series exclusively for the European market. The exterior design harmonizes beautifully with any decor and adds comfortable elegance to the room. The light, elegant and three-dimensional expression achieved by the curved surface is beautiful from any angle.

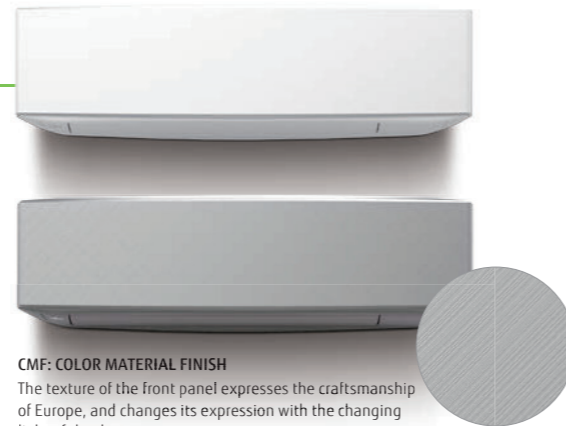

CMF: COLOR MATERIAL FINISH
The texture of the front panel expresses the craftsmanship of Europe, and changes its expression with the changing light of the day.

High energy saving

High-efficiency has been achieved by the lambda heat exchanger, large cross-flow fan, and the new refrigerant.

Rank Cooling*1
A++
Rank Heating*2
A+

SEER 7.4 *1
*1: 07/09 models

SCOP 4.4 *2
*2: 12 model

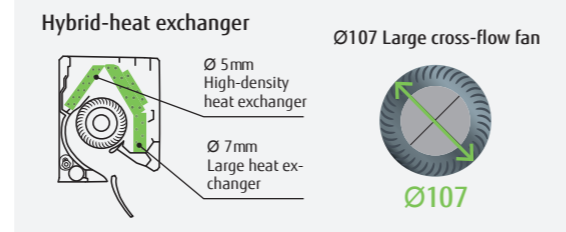

Comfortable airflow & Quiet operation

The large louver and the new air-blowing structure create a comfortable air flow that spreads all the way down to the user's feet with quiet operation.



Smart Device control (Option)

With the optional WLAN adapter installed in the air conditioner, you can control it from anywhere with your smart device. WLAN adapter can be installed easily without specialized installation work.

You need to install the FGLair app on your smart device in order to control the air conditioner.

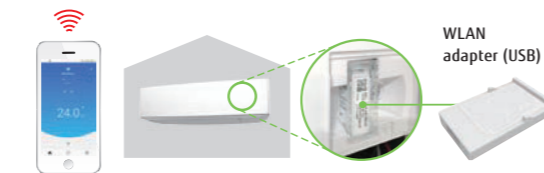

**Model: ASYG07KETA/ASYG09KETA/ASYG12KETA/ASYG14KETA
ASYG07KETA-B/ASYG09KETA-B/ASYG12KETA-B/ASYG14KETA-B**



Peal white X White



Silver X Dark gray



Wireless RC



For ASYG07/09/12KETA-B



For ASYG14KETA-B

Specifications

Model name	Indoor unit		ASYG07KETA ASYG07KETA-B	ASYG09KETA ASYG09KETA-B	ASYG12KETA ASYG12KETA-B	ASYG14KETA ASYG14KETA-B
	Outdoor unit		AOYG07KETA	AOYG09KETA	AOYG12KETA	AOYG14KETA
Power Source	Single phase, ~230 V, 50 Hz					
Capacity	Cooling	kW	2.0 (0.9 - 3.0)	2.5 (0.9 - 3.2)	3.4 (0.9 - 3.9)	4.2 (0.9 - 4.4)
	Heating		2.5 (0.9 - 3.4)	2.8 (0.9 - 4.0)	4.0 (0.9 - 5.3)	5.4 (0.9 - 6.0)
Input Power	Cooling/Heating	kW	0.450/0.555	0.630/0.620	0.935/0.960	1.220/1.410
EER	Cooling		4.43	3.97	3.65	3.44
COP	Heating	4.52	4.52	4.17	3.83	
Pdesign	Cooling/Heating (-10°C)	kW	2.0/2.3	2.5/2.4	3.4/2.5	4.2/4.0
SEER	Cooling		7.40	7.40	7.30	6.9
SCOP	Heating (Average)	W/W	4.10	4.10	4.40	4.1
Energy Efficiency Class	Cooling		A++	A++	A++	A++
	Heating (Average)	A+	A+	A+	A+	
Max. Operating Current	Cooling/Heating	A	6.5/9.0	6.5/9.0	6.5/9.0	6.5/9.0
Annual Energy Consumption	Cooling		kWh/a	95	118	163
	Heating	785		819	795	1,367
Moisture Removal		l/h	1.0	1.3	1.8	2.1
Sound Pressure Level	Indoor (Cooling)		H/M/L/Q	38/33/29/20	40/34/29/20	40/35/30/20
	Indoor (Heating)	H/M/L/Q	41/35/31/22	42/36/31/22	42/38/33/22	44/39/33/24
	Outdoor (Cooling/Heating)	High	46/46	46/46	50/50	50/50
Sound Power Level	Indoor (Cooling/Heating)	High	54/56	55/57	55/58	57/59
	Outdoor (Cooling/Heating)	High	61/61	61/62	65/65	65/66
Airflow Rate	Indoor/Outdoor (Cooling)	High	650/1,650	700/1,650	700/1,700	770/1,680
	Indoor/Outdoor (Heating)	High	720/1,450	750/1,450	770/1,470	800/1,580
Net Dimensions	Indoor	mm	295 × 950 (wall side: 840) × 230			
H x W x D	Outdoor		mm	541 × 663 × 290	541 × 663 × 290	541 × 663 × 290
Weight	Indoor	kg (lbs)	11 (24)	11 (24)	11 (24)	11.5 (25)
	Outdoor		kg (lbs)	23 (51)	23 (51)	25 (55)
Connection Pipe Diameter (Liquid/Gas)		mm	6.35/9.52	6.35/9.52	6.35/9.52	6.35/9.52
Drain Hose Diameter (I.D./O.D.)			13.8/15.0 to 16.8	13.8/15.0 to 16.8	13.8/15.0 to 16.8	13.8/15.0 to 16.8
Max. Pipe Length (Pre-Charge)		m	20 (15)	20 (15)	20 (15)	20 (15)
Max. Height Difference			15	15	15	15
Operating Range	Cooling	°CDB	-10 to 46	-10 to 46	-10 to 46	-10 to 46
	Heating		-15 to 24	-15 to 24	-15 to 24	-15 to 24
Refrigerant	Type (Global Warming Potential)	kg (CO2eq-T)	R32 (675)	R32 (675)	R32 (675)	R32 (675)
	Charge		0.6 (0.405)	0.6 (0.405)	0.7 (0.473)	0.85 (0.574)

Optional parts

* For optional parts compatibility of Inesis devices, refer to the optional parts compatibility list Page C-046.

Compact wired remote controller:	UTY-RCRYZ1	Communication kit:	UTY-TWRXZ2	Network Converter for single split (DC power supply type):	UTY-VTGX
Wired remote controller (touch panel):	UTY-RNRYZ5	External input and output PCB:	UTY-XCSXZ2	Network Converter for single split (AC power supply type):	UTY-VTGXV
Wired remote controller:	UTY-RLRY	External connect kit:	UTY-XWZXZ5	Silver Ion filter:	UTR-FA16-5
Simple remote controller (without operation mode):	UTY-RHRY	External switch controller:	UTY-TERX		
Simple remote controller:	UTY-RSRY	WLAN adapter:	UTY-TFSXF2		

Dimensions

(Unit: mm)

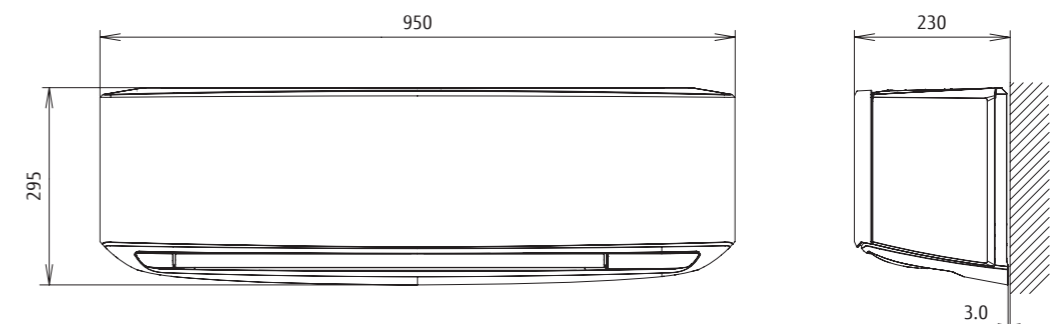

Wall-mounted type

Standard Series

High-Efficiency & Comfort



Slim & stylish square design

The slim and stylish square design of this indoor unit is realized by using a high-density, multipath heat exchanger and a high-efficiency wind blower.

Hybrid-heat exchanger

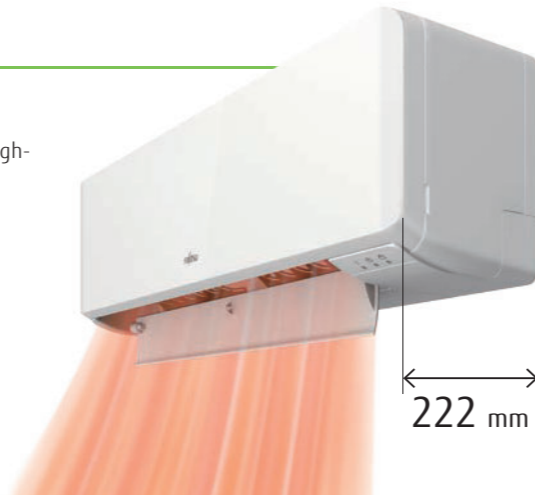
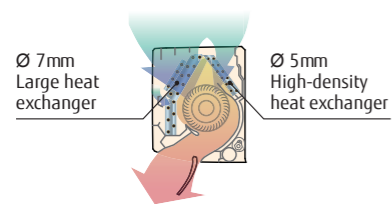

High energy saving

High-efficiency has been achieved by the lambda heat exchanger, large cross-flow fan, and the new refrigerant.

Rank Cooling **A++** Heating **A+**

SEER **7.4** *1 SCOP **4.4** *2

*1: 07/09 models *2: 12 model

Comfortable airflow & Quiet operation

The large louver and the new air-blowing structure create a comfortable air flow that spreads all the way down to the user's feet with quiet operation.



Smart device Control (Option)

Using a smartphone, tablet, or PC, you can easily control the air conditioner both inside and outside your home or office.

WLAN adapter
The optional WLAN adapter enables the air conditioner to be operated by smartphone or tablet PC from outside the home.

Model: ASYG07KMCC/ASYG09KMCC/ASYG12KMCC/ASYG14KMCC



Specifications

Model name	Indoor unit		ASYG07KMCC	ASYG09KMCC	ASYG12KMCC	ASYG14KMCC
	Outdoor unit		AOYG07KMCC	AOYG09KMCC	AOYG12KMCC	AOYG14KMCC
Power Source	Single phase, ~230 V, 50 Hz					
Capacity	Cooling	kW	2.0 (0.9-3.0)	2.5 (0.9-3.2)	3.4 (0.9-3.9)	4.2 (0.9-4.4)
	Heating	kW	2.5 (0.9-3.4)	2.8 (0.9-4.0)	4.0 (0.9-5.3)	5.4 (0.9-6.0)
Input Power	Cooling/Heating		0.450/0.555	0.630/0.620	0.935/0.960	1.220/1.410
	Cooling	W/W	4.43	3.97	3.65	3.44
EER	Heating		4.52	4.52	4.17	3.83
	Cooling/Heating (-10°C)	kW	2.0/2.3	2.5/2.4	3.4/2.5	4.2/4.0
SEER	Cooling		7.40	7.40	7.30	6.90
	Heating (Average)		4.10	4.10	4.40	4.10
SCOP	Cooling		A++	A++	A++	A++
	Heating (Average)		A+	A+	A+	A+
Max. Operating Current	Cooling/Heating		6.5/9.0	6.5/9.0	6.5/9.0	6.5/9.0
	Cooling	kWh/a	95	118	163	213
Annual Energy Consumption	Heating		785	819	795	1367
	Moisture Removal		l/h	1.0	1.3	1.8
Sound Pressure Level	Indoor (Cooling)	H/M/L/Q	38/33/29/20	40/34/29/20	40/35/30/20	43/36/30/20
	Indoor (Heating)	H/M/L/Q	41/35/31/22	42/36/31/22	42/38/33/22	44/39/33/24
Sound Power Level	Outdoor (Cooling/Heating)	High	46/46	46/46	50/50	50/50
	Indoor (Cooling/Heating)	High	54/56	55/57	55/58	57/59
Airflow Rate	Outdoor (Cooling/Heating)	High	61/61	61/62	65/65	65/66
	Indoor/Outdoor (Cooling)	High	650/1,650	700/1,650	700/1,700	770/1,680
Net Dimensions H x W x D	Indoor/Outdoor (Heating)	High	720/1,450	750/1,450	780/1,470	820/1,580
	Indoor	mm	270 × 834 × 222	270 × 834 × 222	270 × 834 × 222	270 × 834 × 222
Weight	Outdoor	mm	541 × 663 × 290	541 × 663 × 290	541 × 663 × 290	542 × 799 × 290
	Indoor	kg (lbs)	10 (22)	10 (22)	10 (22)	10 (22)
Connection Pipe Diameter (Liquid/Gas)	Indoor	kg (lbs)	22 (49)	22 (49)	24 (53)	31 (68)
	Outdoor	kg (lbs)	22 (49)	22 (49)	24 (53)	31 (68)
Drain Hose Diameter (I.D./O.D.)	mm		6.35/9.52	6.35/9.52	6.35/9.52	6.35/9.52
Max. Pipe Length (Pre-Charge)	mm		11.8/15.0 to 16.8	11.8/15.0 to 16.8	11.8/15.0 to 16.8	11.8/15.0 to 16.8
Max. Height Difference	m		20 (15)	20 (15)	20 (15)	20 (15)
Operating Range	°CDB		15	15	15	15
	Cooling	°CDB	-10 to 46	-10 to 46	-10 to 46	-10 to 46
Refrigerant	Heating		-15 to 24	-15 to 24	-15 to 24	-15 to 24
	Type (Global Warming Potential)		R32 (675)	R32 (675)	R32 (675)	R32 (675)
Charge	kg (CO2eq-T)		0.6 (0.405)	0.6 (0.405)	0.7 (0.473)	0.85 (0.574)

Optional parts

* For optional parts compatibility of Inesis devices, refer to the optional parts compatibility list Page C-046.

Wired remote controller:	UTY-RNNYM	WLAN adapter:	UTY-TFSXW1
	UTY-RVNYM	External switch controller:	UTY-TERX
Simple remote controller:	UTY-RSNYM	Network Converter for single split (DC power supply type):	UTY-VTGX
External connect kit:	UTY-XWZXZ5	Network Converter for single split (AC power supply type):	UTY-VTGXV
Communication kit:	UTY-TWBXF2	Silver Ion filter:	UTR-FA16-5

Dimensions

(Unit: mm)

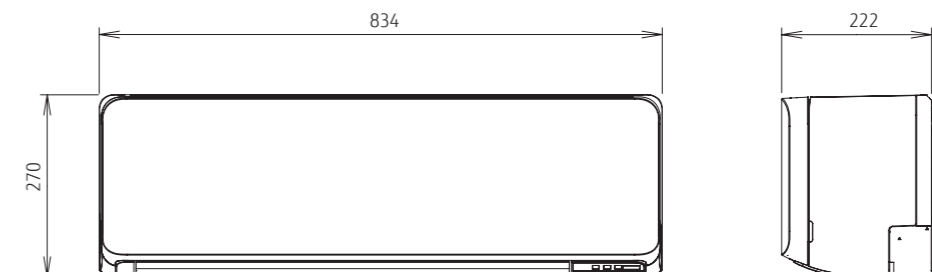

Wall-mounted type

Standard Series

High-Efficiency & Large Rooms



High energy saving

High-efficiency has been achieved by the lambda heat exchanger, large cross-flow fan, and the new refrigerant.



Hybrid-heat exchanger

The large hybrid heat exchanger has greatly improved the heat exchange efficiency to achieve top-level SEER and SCOP.

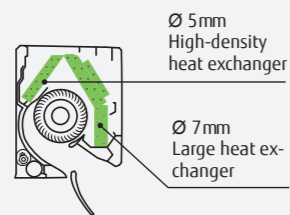

Ø107 Large cross-flow fan

The large-diameter fan generates air volume efficiently even at reduced power.

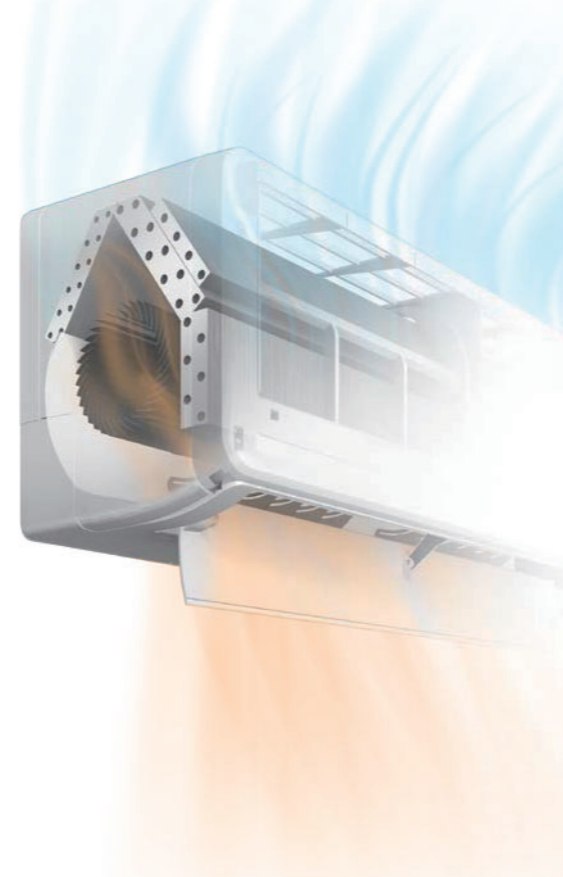
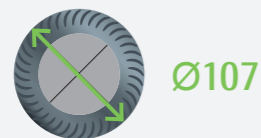

Smart device Control (Option)

With the optional WLAN adapter installed in the air conditioner, you can control it from anywhere with your smart device. WLAN adapter can be installed easily without specialized installation work.

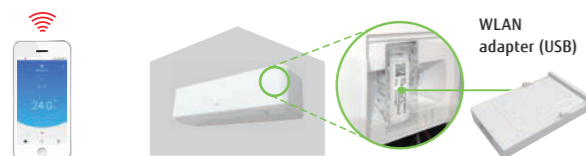

Low ambient operation

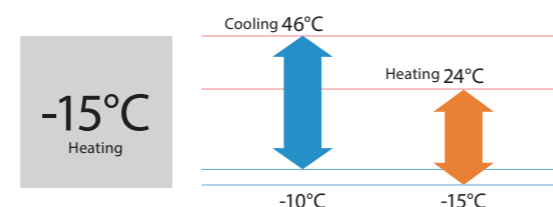

Model: ASYG18KMTB/ASYG24KMTB



Specifications

Model name	Indoor unit		Outdoor unit		ASYG18KMTB		ASYG24KMTB	
	Outdoor unit		AOYG18KMTA		AOYG24KMTA		AOYG24KMTA	
Power Source	Single phase, ~230 V, 50 Hz							
Capacity	Cooling	kW	5.2 (0.9-6.0)		7.1 (0.9-8.3)			
	Heating	kW	6.3 (0.9-8.7)		8.0 (0.9-10.1)			
Input Power	Cooling/Heating		1.39/1.56		2.08/1.91			
	EER		3.74		3.41			
COP	Cooling	W/W	4.04		4.19			
	Heating	W/W	5.2/4.8		7.1/7.1			
Pdesign	Cooling/Heating (-10°C)		7.77		7.28			
SEER	Cooling		4.56		4.18			
SCOP	Heating (Average)		A++		A++			
Energy Efficiency Class	Cooling		A+		A+			
	Heating (Average)		A		A			
Max. Operating Current	Cooling/Heating		9.5/13.5		13.5/16.0			
	Annual Energy Consumption	kWh/a	234		341			
Moisture Removal	Cooling	l/h	1.472		2.372			
	Heating	l/h	1.7		2.7			
Sound Pressure Level	Indoor (Cooling)	H/M/L/Q	45/40/35/29		49/40/35/29			
	Indoor (Heating)	H/M/L/Q	46/40/35/29		49/40/35/29			
	Outdoor (Cooling/Heating)	High	50/50		54/52			
Sound Power Level	Indoor (Cooling/Heating)	High	60/61		65/65			
	Outdoor (Cooling/Heating)	High	65/65		67/66			
	Airflow Rate	Indoor/Outdoor (Cooling)	High	980/2,350		1,170/3,240		
Net Dimensions H x W x D	Indoor	mm	1,020/2,100		1,170/2,820			
	Outdoor	mm	280 x 980 x 240		280 x 980 x 240			
Weight	Indoor	kg (lbs)	632 x 799 x 290		716 x 820 x 315			
	Outdoor	kg (lbs)	12.5 (28)		12.5 (28)			
Connection Pipe Diameter (Liquid/Gas)	Indoor	kg (lbs)	36 (79)		42 (93)			
	Outdoor	kg (lbs)	6.35/12.70		6.35/12.70			
Drain Hose Diameter (I.D./O.D.)	mm	13.8/15.8 to 16.7		13.8/15.8 to 16.7				
Max. Pipe Length (Pre-Charge)	m	25 (15)		30 (15)				
Max. Height Difference		20		25				
Operating Range	Cooling	°CDB	-10 to 46		-10 to 46			
	Heating	°CDB	-15 to 24		-15 to 24			
Refrigerant	Type (Global Warming Potential)		R32 (675)		R32 (675)			
	Charge	kg (CO2eq-T)	1.02 (0.689)		1.32 (0.891)			

Optional parts

* For optional parts compatibility of Intesis devices, refer to the optional parts compatibility list Page C-046.

Compact wired remote controller:	UTY-RCRYZ1	Communication kit:	UTY-TWRXZ2	Network Converter for single split (DC power supply type):	UTY-VTGX
Wired remote controller (touch panel):	UTY-RNRYZ5	External input and output PCB:	UTY-XCSXZ2	Network Converter for single split (AC power supply type):	UTY-VTGXV
Wired remote controller:	UTY-RLRY	External connect kit:	UTY-XWZXZ5	Silver Ion filter:	UTR-FA16-5
Simple remote controller (without operation mode):	UTY-RHRY	WLAN adapter:	UTY-TFSXF2		
Simple remote controller:	UTY-RSRY	External switch controller:	UTY-TERX		

Dimensions

(Unit: mm)

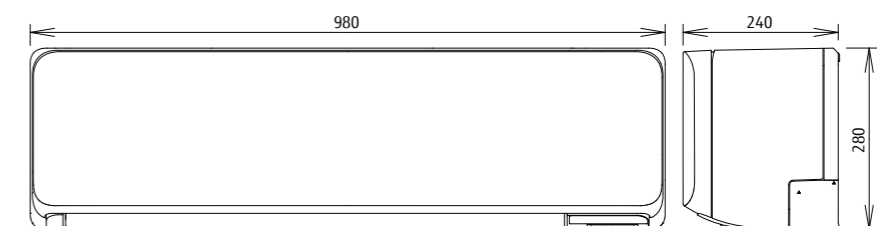

Wall-mounted type

Standard Series

High-Efficiency & Large Rooms



Small, lightweight outdoor unit

The outdoor unit in this series is smaller and lighter than previous-generation outdoor units. It can be installed in a narrow space.



Human sensor

The Human sensor monitors the movements of people in a room and operates the air conditioner at a lower capacity when people leave the room. When people come back to the room, it automatically returns to the previous operating mode.

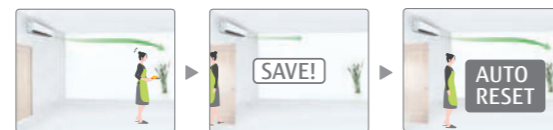

Adopting new R32 refrigerant

R32 refrigerant is an environmentally friendly refrigerant with a significantly lower Global Warming Potential (GWP) than conventional refrigerant.



Smart Device control (option)

With the optional WLAN adapter installed in the air conditioner, you can control it from anywhere with your smart device. WLAN adapter can be installed easily without specialized installation work.

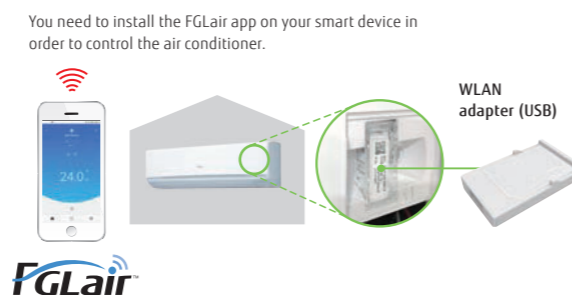

Model: ASYG30KMTA/ASYG36KMTA



Specifications

Model name	Indoor unit		Outdoor unit		ASYG30KMTA	ASYG36KMTA
	Outdoor unit		Outdoor unit		AOYG30KMTA	AOYG36KMTA
Power Source	Single phase, ~230 V, 50 Hz					
Capacity	Cooling	kW			8.0 (2.9-9.0)	9.4 (2.9-10.0)
	Heating	kW			8.8 (2.2-11.0)	10.1 (2.7-11.2)
Input Power	Cooling/Heating		kW		2.33/2.20	3.16/2.73
	Cooling	W/W			3.43	2.97
EER	Cooling		W/W		4.00	3.70
	Heating		W/W		3.70	3.40
COP	Cooling/Heating (-10°C)		kW		8.0/6.5	9.4/7.1
	Cooling		W/W		6.67	6.14
Pdesign	Cooling/Heating (Average)		W/W		4.54	4.52
	Cooling		W/W		4.54	4.52
SEER	Cooling		W/W		4.54	4.52
	Heating (Average)		W/W		4.54	4.52
SCOP	Cooling		W/W		A++	A++
	Heating (Average)		W/W		A+	A+
Max. Operating Current	Cooling/Heating		A		21.0/21.0	21.5/21.5
	Cooling		kWh/a		419	535
Annual Energy Consumption	Cooling		kWh/a		419	535
	Heating		kWh/a		2,001	2,198
Moisture Removal	Cooling		l/h		2.6	3.8
	Heating		l/h		2.6	3.8
Sound Pressure Level	Indoor (Cooling)	H/M/L/Q			50/44/40/33	50/44/40/33
	Indoor (Heating)	H/M/L/Q			49/44/39/33	49/44/39/33
	Outdoor (Cooling/Heating)	High	dB(A)		53/55	55/55
Sound Power Level	Indoor (Cooling/Heating)	High			65/65	65/65
	Outdoor (Cooling/Heating)	High			68/69	70/70
	Outdoor (Cooling/Heating)	High			68/69	70/70
Airflow Rate	Indoor/Outdoor (Cooling)	High	m³/h		1,330/3,750	1,330/3,750
	Indoor/Outdoor (Heating)	High	m³/h		1,330/3,750	1,330/3,750
Net Dimensions H x W x D	Indoor	mm			340 x 1,150 x 280	340 x 1,150 x 280
	Outdoor	mm			788 x 940 x 320	788 x 940 x 320
Weight	Indoor	kg (lbs)			18.5 (41)	18.5 (41)
	Outdoor	kg (lbs)			52.0 (115)	52.0 (115)
Connection Pipe Diameter (Liquid/Gas)	Indoor		mm		9.52/15.88	9.52/15.88
	Outdoor		mm		13.8/15.8 to 16.7	13.8/15.8 to 16.7
Drain Hose Diameter (I.D./O.D.)	Indoor		mm		13.8/15.8 to 16.7	13.8/15.8 to 16.7
	Outdoor		mm		13.8/15.8 to 16.7	13.8/15.8 to 16.7
Max. Pipe Length (Pre-Charge)	Indoor		m		50 (30)	50 (30)
	Outdoor		m		50 (30)	50 (30)
Max. Height Difference	Indoor		m		30	30
	Outdoor		m		30	30
Operating Range	Cooling		°CDB		-15to46	-15to46
	Heating		°CDB		-15to24	-15to24
Refrigerant	Type (Global Warming Potential)				R32 (675)	R32 (675)
	Charge		kg (CO2eq-T)		1.90 (1.283)	1.90 (1.283)

Optional parts

* For optional parts compatibility of Intesis devices, refer to the optional parts compatibility list Page C-046.

Compact wired remote controller:	UTY-RCRYZ1	External connect kit:	UTY-XWZX25	Network Converter for single split (DC power supply type):	UTY-VTGX
Wired remote controller (touch panel):	UTY-RNRYZ5	External Input and Output PCB:	UTY-XCSXZ2	Network Converter for single split (AC power supply type):	UTY-VTGXV
Wired remote controller:	UTY-RLRY	Communication kit:	UTY-TWRXZ2	Silver Ion Filter:	UTR-FA13-3
Simple remote controller (without operation mode):	UTY-RHRY	WLAN adapter:	UTY-TFSXF2		
Simple remote controller:	UTY-RSRY	External switch controller:	UTY-TERX		

Dimensions

(Unit: mm)

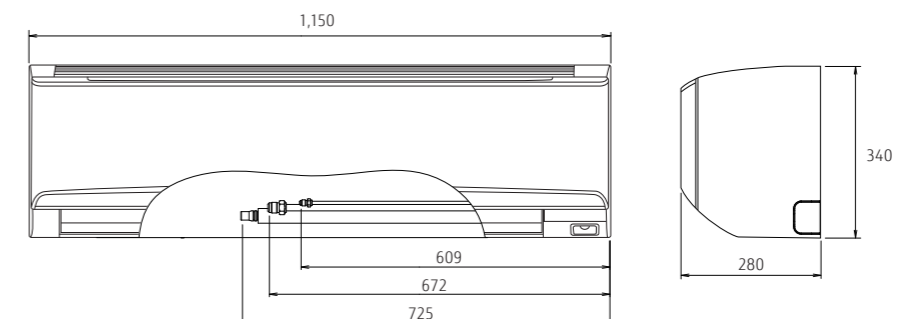

Wall-mounted type
ECO Series
Compact Size



Slim & stylish square design

The slim and stylish square design of this indoor unit is realized by using a high-density, multipath heat exchanger and a high-efficiency wind blower.



High energy saving

High-efficiency has been achieved by the lambda heat exchanger, large cross-flow fan, and the new refrigerant.

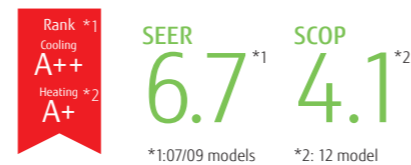

Comfortable airflow & Quiet operation

The large louver and the new air-blowing structure create a comfortable air flow that spreads all the way down to the user's feet with quiet operation.



Smart device Control (Option)

With the optional WLAN adapter installed in the air conditioner, you can control it from anywhere with your smart device. WLAN adapter can be installed easily without specialized installation work.

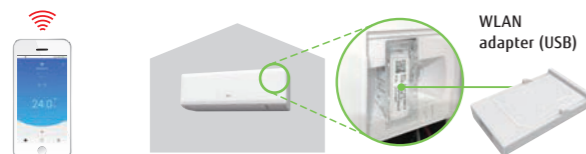

Low ambient operation

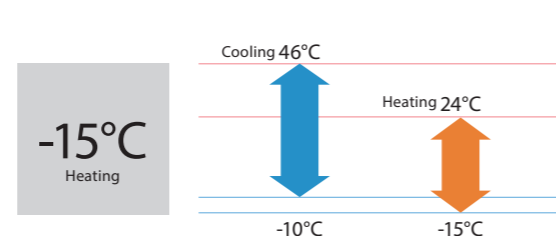

Model: ASYG07KPCA/ASYG09KPCA/ASYG12KPCA



Wireless RC



Specifications

Model name	Indoor unit		ASYG07KPCA	ASYG09KPCA	ASYG12KPCA
	Outdoor unit		AOYG07KPCA	AOYG09KPCA	AOYG12KPCA
Power Source	Single phase, ~230 V, 50 Hz				
Capacity	Cooling	kW	2.0 (0.9-2.8)	2.5 (0.9-3.0)	3.4 (0.9-3.7)
	Heating	kW	2.5 (0.9-3.4)	2.8 (0.9-3.8)	3.8 (0.9-4.8)
Input Power	Cooling/Heating		0.48/0.63	0.71/0.79	1.00/1.14
	Cooling	W/W	4.17	3.52	3.40
EER	Heating		3.97	3.54	3.33
	Cooling/Heating (-10°C)	kW	2.0/2.2	2.5/2.4	3.4/2.5
SEER	Cooling		6.70	6.70	6.30
	Heating (Average)		4.00	4.00	4.10
SCOP	Cooling		A++	A++	A++
	Heating (Average)		A+	A+	A+
Max. Operating Current	Cooling/Heating		6.5/9.0	6.5/9.0	6.5/9.0
	Cooling	A	104	131	189
Annual Energy Consumption	Cooling		769	840	853
	Heating		1.0	1.3	1.8
Moisture Removal	Cooling		45/38/31/22	45/38/31/22	46/40/33/22
	Heating		45/40/36/26	45/40/36/26	46/40/35/27
Sound Pressure Level	Indoor (Cooling)	H/M/L/Q	45/46	47/47	49/51
	Indoor (Heating)	H/M/L/Q	57/58	58/58	59/59
Sound Power Level	Outdoor (Cooling/Heating)	High	57/58	59/59	62/62
	Indoor (Cooling/Heating)	High	580/1,650	580/1,650	630/1,700
Airflow Rate	Indoor/Outdoor (Cooling)	High	580/1,450	580/1,450	630/1,470
	Indoor/Outdoor (Heating)	High	270 × 784 × 224	270 × 784 × 224	270 × 784 × 224
Net Dimensions H x W x D	Indoor	mm	541 × 663 × 290	541 × 663 × 290	541 × 663 × 290
	Outdoor	mm	8 (18)	8 (18)	8 (18)
Weight	Indoor	kg (lbs)	23 (51)	23 (51)	25 (55)
	Outdoor	kg (lbs)	6.35/9.52	6.35/9.52	6.35/9.52
Connection Pipe Diameter (Liquid/Gas)	mm		11.8/15.0 to 16.8	11.8/15.0 to 16.8	11.8/15.0 to 16.8
Drain Hose Diameter (I.D./O.D.)	mm		20 (15)	20 (15)	20 (15)
Max. Pipe Length (Pre-Charge)	m		15	15	15
Max. Height Difference	Cooling		-10 to 46	-10 to 46	-10 to 46
	Heating		-15 to 24	-15 to 24	-15 to 24
Operating Range	Type (Global Warming Potential)		R32 (675)	R32 (675)	R32 (675)
	Charge		kg (CO2eq-T)	0.55 (0.371)	0.55 (0.371)

Optional parts

* For optional parts compatibility of Inetis devices, refer to the optional parts compatibility list Page C-046.

- WLAN adapter: UTY-TFSXF2
- Remote controller holder kit: UTZ-RXLA
- Silver Ion Filter: UTR-FA16-5

Dimensions

(Unit: mm)

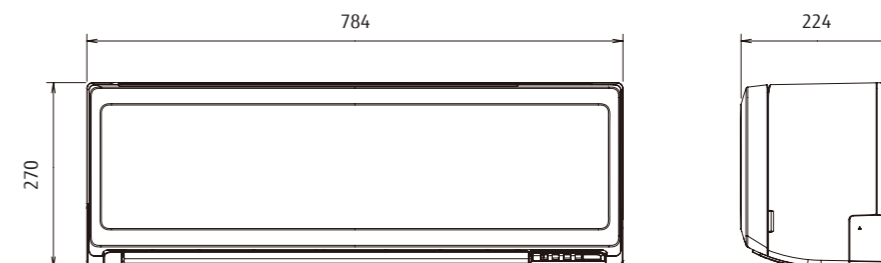

Wall-mounted type

ECO Series

Comfort for Large Rooms



Model: ASYG18KLCA/ASYG24KLCA



Wireless RC



For ASYG18KLCA



For ASYG24KLCA

Specifications

Model name	Indoor unit		Outdoor unit		ASYG18KLCA	ASYG24KLCA	
	Indoor unit		Outdoor unit		AOYG18KLCA	AOYG24KLCA	
Power Source	Single phase, ~230 V, 50 Hz						
Capacity	Cooling	kW			5.2 (0.9-5.5)	7.1 (0.9-7.7)	
	Heating				6.3 (0.6-7.6)	8.0 (0.9-9.0)	
Input Power	Cooling/Heating		kW			1.685/1.80	2.42/2.225
	Cooling					3.09	2.93
EER	Cooling		W/W			3.50	3.60
	Heating					5.20/4.80	7.10/7.10
Pdesign	Cooling/Heating (-10°C)		kW			7.20	7.10
	Cooling					4.30	4.00
SEER	Cooling		W/W			A++	A++
	Heating (Average)					A+	A+
SCOP	Cooling		A			253	350
	Heating (Average)					1563	2485
Max. Operating Current	Cooling/Heating		kWh/a			1.9	3.1
	Cooling					47/44/40/35	51/45/38/33
Annual Energy Consumption	Cooling		I/h			50/45/41/37	52/45/41/37
	Heating					50/56	55/57
Moisture Removal	Indoor (Cooling)	H/M/L/Q	dB(A)			60/65	64/65
	Indoor (Heating)	H/M/L/Q				61/66	65/67
Sound Pressure Level	Outdoor (Cooling/Heating)	High	m³/h			865/1,830	1,040/2,885
	Indoor (Cooling/Heating)	High				995/2,265	1,040/3,030
Sound Power Level	Indoor (Cooling/Heating)	High	mm			293 × 790 × 249	293 × 790 × 249
	Outdoor (Cooling/Heating)	High				542 × 799 × 290	632 × 799 × 290
Airflow Rate	Indoor	kg (lbs)	kg (lbs)			9.5 (21)	10.0 (22)
	Outdoor	kg (lbs)				33 (73)	38 (84)
Net Dimensions	Indoor				6.35/9.52	6.35/12.70	
	Outdoor				13.8/15.8 to 16.7	13.8/15.8 to 16.7	
H x W x D	Indoor				25 (15)	30 (15)	
	Outdoor				20	25	
Weight	Cooling		°CDB			-10 to 46	-10 to 46
	Heating					-15 to 24	-15 to 24
Connection Pipe Diameter (Liquid/Gas)	Type (Global Warming Potential)				0.85 (0.574)	1.10 (0.743)	
	Charge						
Drain Hose Diameter (I.D./O.D.)	Refrigerant						
	Max. Pipe Length (Pre-Charge)						
Max. Height Difference	Max. Height Difference						
	Operating Range						

Narrow width & Compact Design

Compact and versatile. Powerful airflow is realized despite the 790-mm width compact design for small spaces such as bedrooms or home offices.



Economy operation

Set temperature automatically increases or decreases by 1°C. The thermostat setting is adjusted automatically according to the room temperature to avoid unnecessary cooling or heating.

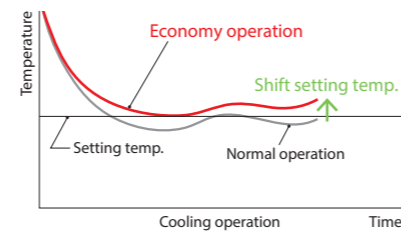

Powerful operation

In powerful operation mode, the compressor operates at maximum speed for 20 minutes to provide a powerful airflow. Rapid cooling and heating makes the room comfortable quickly.

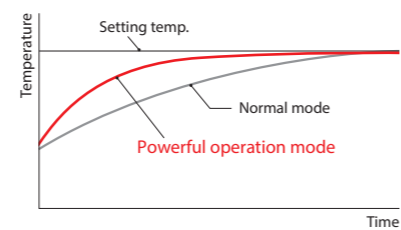

ON-OFF Programmable timer

You can set ON/OFF or OFF/ON times depending on your lifestyle needs. (Setting time: 0.5, 1, 1.5, 2, 2.5, ----9.5, 10, 11, 12 hours)

Low ambient operation

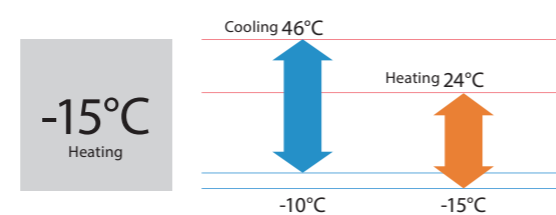

Optional parts

* For optional parts compatibility of Intesis devices, refer to the optional parts compatibility list Page C-046.

Silver Ion Filter: UTR-FA16-5

Dimensions

(Unit: mm)

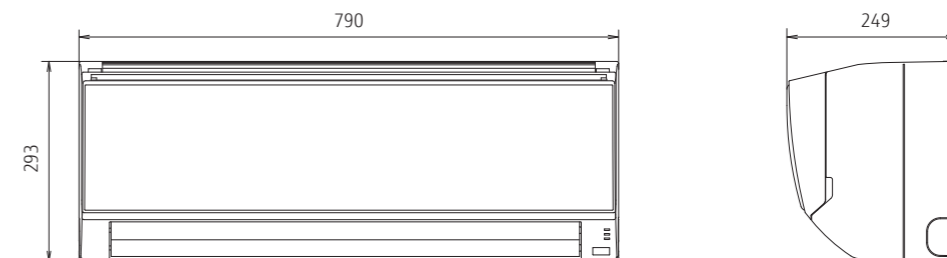

Compact Cassette

Compact 4-way Flow Series

Compact Size



Model: AUXG09KVLA /AUXG12KVLA/AUXG14KVLA/AUXG18KVLA/AUXG22KVLA/AUXG24KVLA



Specifications

Model name	Indoor unit		AUXG09KVLA	AUXG12KVLA	AUXG14KVLA	AUXG18KVLA	AUXG22KVLA	AUXG24KVLA
	Outdoor unit		AOYG09KBTB	AOYG12KBTB	AOYG14KBTB	AOYG18KBTB	AOYG22KBTB	AOYG24KBTB
Power Source			Single phase, ~230 V, 50 Hz					
Capacity	Cooling	kW	2.5 (0.9-3.2)	3.5 (0.9-4.4)	4.3 (0.9-5.4)	5.2 (0.9-5.9)	6.0 (0.9-6.7)	6.8 (0.9-8.0)
	Heating		3.2 (0.9-4.7)	4.1 (0.9-5.7)	5.0 (0.9-6.5)	6.0 (0.9-7.5)	7.0 (0.9-8.0)	7.5 (0.9-9.1)
Input Power	Cooling/Heating	kW	0.55/0.79	0.93/1.08	1.28/1.32	1.60/1.66	1.82/1.87	2.21/2.03
EER	Cooling	W/W	4.57	3.76	3.36	3.25	3.30	3.08
	Heating		4.05	3.80	3.79	3.61	3.74	3.69
Pdesign	Cooling/Heating (-10°C)	kW	2.5/2.6	3.5/3.4	4.3/3.8	5.2/4.4	6.0/4.8	6.8/6.0
SEER	Cooling	W/W	6.70	6.60	6.50	6.60	6.60	6.10
SCOP	Heating (Average)	W/W	4.40	4.30	4.40	4.20	4.30	4.00
Energy Efficiency Class	Cooling		A++	A++	A++	A++	A++	A++
	Heating (Average)		A+	A+	A+	A+	A+	A+
Max. Operating Current	Cooling/Heating	A	7.9/7.9	9.7/9.7	10.2/10.2	12.1/12.1	12.6/12.6	13.6/13.6
	Cooling		kWh/a	131	186	231	275	318
Annual Energy Consumption	Heating	kWh/a	826	1,106	1,208	1,466	1,562	2,097
	Moisture Removal		l/h	0.6	1.2	1.5	2.2	2.6
Sound Pressure Level	Indoor (Cooling)	H/M/L/Q	33/31/29/27					
	Indoor (Heating)		34/32/29/27					
Sound Power Level	Outdoor (Cooling/Heating)	High	46/46					
	Indoor (Cooling/Heating)		High	46/47				
Airflow Rate	Indoor/Outdoor (Cooling)	High	540/1,480					
	Indoor/Outdoor (Heating)		High	540/1,410				
Net Dimensions H x W x D	Indoor	mm	245 x 570 x 570					
	Outdoor		542 x 799 x 290					
Weight	Indoor	kg (lbs)	15 (33)					
	Outdoor		32 (71)					
Connection Pipe Diameter (Liquid/Gas)	mm		6.35/9.52					
Drain Hose Diameter (I.D./O.D.)	mm		25/32					
Max. Pipe Length (Pre-Charge)	m		20 (15)					
Max. Height Difference	Cooling	°CDB	-15 to 46					
	Heating		-15 to 24					
Refrigerant	Type (Global Warming Potential)	kg (CO2eq-T)	R32 (675)					
	Charge		0.85 (0.574)					
Cassette Grille	Model name	mm	UTG-UFYF-W					
	Dimensions (H x W x D)		49 x 620 x 620					
Weight	kg (lbs)	2.3 (5)						

Compact and stylish panel design

The compact and stylish panel fits nicely into a grid-type ceiling. Its linear design is a perfect fit into a grid of 620 mm x 620 mm in the ceiling.



Easy maintenance

You can access the unit for maintenance simply by removing a ceiling panel next to the grille. As no inspection hole needs to be cut through the ceiling, no additional construction cost is incurred.

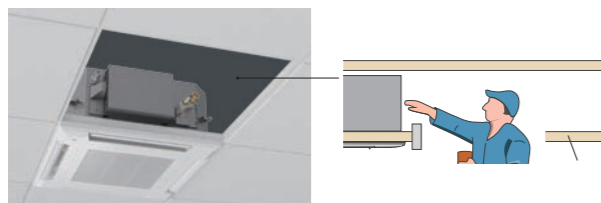

The air inlet grille can be installed to open in any direction for easy maintenance.



Flexible installation

The unit fits nicely into the decor of a grid-type ceiling and can be installed near the lighting or a ventilation opening.



Low ambient operation

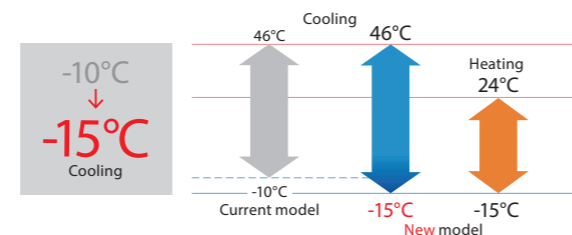

Optional parts

* For optional parts compatibility of Inesis devices, refer to the optional parts compatibility list Page C-046.

Compact wired remote controller:	UTY-RCRYZ1	Wireless remote controller:	UTY-LNTY	Network Converter for single split (DC power supply type):	UTY-VTGX
Wired remote controller (touch panel):	UTY-RNRYZ5	External switch controller:	UTY-TERX	Network Converter for single split (AC power supply type):	UTY-VTGXV
Wired remote controller:	UTY-RLRY	WLAN adapter:	UTY-TFSXZ1	Insulation kit for high humidity:	UTZ-KXGX
	UTY-RNNYM		FJ-RC-WIFI-1	External input and output PCB:	UTY-XCSX
	UTY-RVNYM	Air Outlet Shutter Plate:	UTR-YDZB	External input and output PCB box:	UTZ-GXRA
Simple remote controller (without operation mode):	UTY-RHRY	External connect kit:	UTY-XWZGZG	Silver Ion Filter:	UTD-HFAA
Simple remote controller:	UTY-RSRY	Cassette Grille:	UTG-UFYF-W		
	UTY-RSNYM	Fresh air intake kit:	UTZ-VXAA		

Dimensions

(Unit: mm)

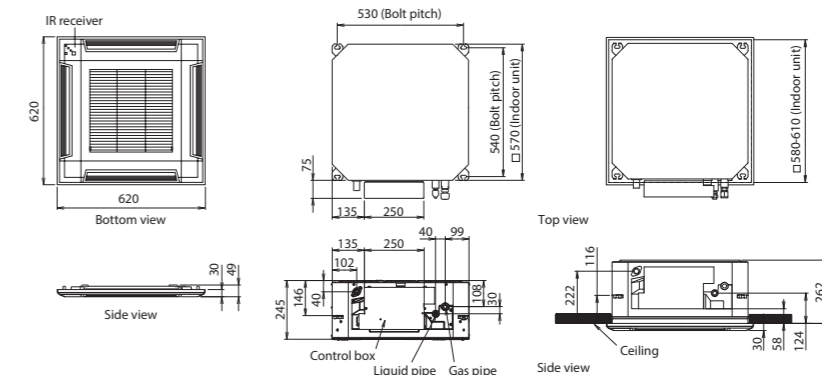

Cassette Circular Flow Series Comfort for Large Rooms

UTG-UKYA-B
Black Grille



Unique Circular Flow design

The Cassette model realizes a Circular Flow to blow a large airflow in a 360° direction by using a high-performance DC fan motor, turbo fan, and a unique seamless airflow louver design.

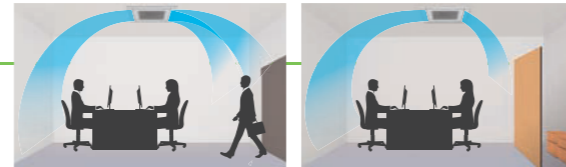

Airflows avoid blowing cool air directly at the occupants in the room, providing more comfortable air conditioning. Provides efficient air conditioning based on the room layout.

Individual louver control

Each louver can be controlled individually with a wired remote controller equipped with a touch panel to provide different directional airflows according to the room layout.

*Wired remote controller (touch panel) (UTY-RNRYZ3) only

The Human sensor yields more energy savings.
Energy saving operation starts automatically by detecting the motion of a person. Two modes of save operation mode and stop mode can be selected.

Compact and lightweight outdoor unit

The outdoor units for the 45,000 BTU and 54,000 BTU models have been completely redesigned. Easier installation is achieved for this compact and lightweight outdoor unit.



Low ambient operation

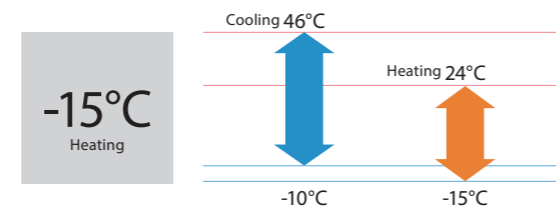

Various Cassette Grilles

Both black and white grilles are available. Three types of grilles are available: a white grille with a remote controller; a white grille without a remote controller; and a black grille without a remote controller. Select to match the atmosphere and/or usage of the room.



Model: AUXG18KRLB/AUXG22KRLB/AUXG24KRLB/AUXG30KRLB/AUXG36KRLB/AUXG45KRLB/AUXG54KRLB
AUXG36KRLB [3-phase]/AUXG45KRLB [3-phase]/AUXG54KRLB [3-phase]



Specifications

Model name	Indoor unit		AUXG18KRLB	AUXG22KRLB	AUXG24KRLB	AUXG30KRLB	AUXG36KRLB	AUXG45KRLB	AUXG54KRLB	AUXG36KRLB	AUXG45KRLB	AUXG54KRLB
	Outdoor unit		AOYG18KBTB	AOYG22KBTB	AOYG24KBTB	AOYG30KBTB	AOYG36KBTB	AOYG45KBTB	AOYG54KBTB	AOYG36KRTA	AOYG45KRTA	AOYG54KRTA
Power Source			Single phase, ~230 V, 50 Hz						3-phase, ~400 V, 50 Hz			
Capacity	Cooling	kW	5.2 (0.9-5.9)	6.0 (0.9-6.7)	6.8 (0.9-8.0)	8.5 (2.8-10.0)	9.5 (2.8-11.2)	12.1 (4.0-14.0)	13.4 (4.5-14.5)	9.5 (2.8-11.2)	12.1 (4.0-14.0)	13.4 (4.5-14.5)
	Heating		6.0 (0.9-7.5)	7.0 (0.9-8.0)	7.5 (0.9-9.1)	10.0 (2.7-11.2)	10.8 (2.7-12.7)	13.5 (4.2-16.2)	15.5 (4.7-16.5)	10.8 (2.7-12.7)	13.5 (4.2-16.2)	15.5 (4.7-16.5)
Input Power	Cooling/Heating	kW	1.36/1.58	1.71/1.82	1.89/1.90	2.44/2.51	2.91/2.45	3.61/3.21	4.41/4.16	2.91/2.45	3.61/3.21	4.41/4.16
	Cooling		3.82	3.51	3.60	3.49	3.26	3.35	3.04	3.26	3.35	3.04
EER	Cooling	W/W	3.80	3.85	3.95	3.98	4.40	4.20	3.73	4.40	4.20	3.73
	Heating		3.80	3.85	3.95	3.98	4.40	4.20	3.73	4.40	4.20	3.73
COP	Cooling/Heating (-10°C)	kW	5.2/4.4	6.0/4.8	6.8/6.0	8.5/8.0	9.5/8.7	-	-	9.5/8.7	-	-
	Cooling		7.00	7.00	6.60	6.70	6.55	-	-	6.55	-	-
SEER	Cooling	W/W	4.30	4.40	4.20	4.30	4.30	-	-	4.30	-	-
	Heating (Average)		4.30	4.40	4.20	4.30	4.30	-	-	4.30	-	-
Energy Efficiency Class	Cooling		A++	A++	A++	A++	A++	-	-	A++	-	-
	Heating (Average)		A+	A+	A+	A+	A+	-	-	A+	-	-
Max. Operating Current	Cooling/Heating	A	12.1/12.1	12.6/12.6	13.6/13.6	22.6/22.6	22.6/22.6	28.5/28.5	28.5/28.5	10.5/10.5	14.0/14.0	14.0/14.0
	Cooling		260	300	360	444	507	-	-	507	-	-
Annual Energy Consumption	Cooling	kWh/a	1,431	1,527	1,999	2,601	2,828	-	-	2,828	-	-
	Heating		1.5	2.2	2.7	2.5	3.3	4.5	5.0	3.3	4.5	5.0
Moisture Removal	Indoor (Cooling)	l/h	33/32/31/28	33/32/31/28	35/33/32/29	40/38/36/33	44/41/38/34	46/42/39/35	47/43/40/36	44/41/38/34	46/42/39/35	47/43/40/36
	Indoor (Heating)		33/32/31/28	33/32/31/28	35/33/32/29	40/38/36/33	44/41/38/34	46/42/39/35	47/43/40/36	44/41/38/34	46/42/39/35	47/43/40/36
Sound Pressure Level	Indoor (Cooling/Heating)	dB(A)	50/50	51/51	53/54	53/55	55/55	57/57	57/59	55/55	57/57	57/59
	Outdoor (Cooling/Heating)		47/47	49/49	49/49	54/54	58/58	60/60	61/61	58/58	60/60	61/61
Sound Power Level	Indoor (Cooling/Heating)	dB(A)	62/62	63/63	65/66	68/69	70/70	71/71	73/73	70/70	71/71	73/73
	Outdoor (Cooling/Heating)		1,050/2,160	1,050/2,240	1,150/2,700	1,600/3,750	1,870/3,750	2,000/4,450	2,100/4,450	1,870/3,750	2,000/4,450	2,100/4,450
Airflow Rate	Indoor/Outdoor (Cooling)	m³/h	1,050/1,830	1,050/1,960	1,150/2,700	1,600/3,750	1,870/3,750	2,000/4,450	2,100/4,450	1,870/3,750	2,000/4,450	2,100/4,450
	Indoor/Outdoor (Heating)		246 × 840 × 840	246 × 840 × 840	246 × 840 × 840	288 × 840 × 840	288 × 840 × 840	288 × 840 × 840	288 × 840 × 840	288 × 840 × 840	288 × 840 × 840	288 × 840 × 840
Net Dimensions H x W x D	Indoor	mm	632 × 799 × 290	632 × 799 × 290	716 × 820 × 315	788 × 940 × 320	788 × 940 × 320	998 × 940 × 320	998 × 940 × 320	788 × 940 × 320	998 × 940 × 320	998 × 940 × 320
	Outdoor		23 (51)	23 (51)	24 (53)	26 (57)	29 (64)	29 (64)	29 (64)	29 (64)	29 (64)	29 (64)
Weight	Indoor	kg (lbs)	36 (79)	38 (84)	42 (93)	52 (115)	52 (115)	67 (148)	67 (148)	53 (117)	67 (148)	67 (148)
	Outdoor		6.35/12.70	6.35/12.70	6.35/12.70	9.52/15.88	9.52/15.88	9.52/15.88	9.52/15.88	9.52/15.88	9.52/15.88	9.52/15.88
Connection Pipe Diameter (Liquid/Gas)		mm	25/32	25/32	25/32	25/32	25/32	25/32	25/32	25/32	25/32	25/32
	Drain Hose Diameter (I.D./O.D.)		30 (20)	30 (20)	30 (20)	50 (30)	50 (30)	50 (30)	50 (30)	50 (30)	50 (30)	50 (30)
Max. Pipe Length (Pre-Charge)		m	20	25	25	30	30	30	30	30	30	30
	Max. Height Difference		-15 to 46	-15 to 46	-15 to 46	-15 to 46	-15 to 46	-15 to 46	-15 to 46	-15 to 46	-15 to 46	-15 to 46
Operating Range	Cooling	°CDB	-15 to 24	-15 to 24	-15 to 24	-15 to 24	-15 to 24	-15 to 24	-15 to 24	-15 to 24	-15 to 24	-15 to 24
	Heating		R32 (675)	R32 (675)	R32 (675)	R32 (675)	R32 (675)	R32 (675)	R32 (675)	R32 (675)	R32 (675)	R32 (675)
Refrigerant	Type (Global Warming Potential)	kg (CO2eq-T)	1.02 (0.689)	1.25 (0.844)	1.25 (0.844)	1.90 (1.283)	1.90 (1.283)	2.70 (1.823)	2.70 (1.823)	1.90 (1.283)	2.70 (1.823)	2.70 (1.823)
	Charge		UTG-UKYA-W: White wired remote controller (touch panel) UTG-UKYC-W: White/UTG-UKYA-B*: Black						UTG-UKYA-W: White wired remote controller (touch panel) UTG-UKYC-W: White/UTG-UKYA-B*: Black			
Cassette Grille	Variation	mm	UTG-UKYA-W: White wired remote controller (touch panel) UTG-UKYC-W: White/UTG-UKYA-B*: Black									
	Dimensions (H × W × D)		53 × 950 × 950	53 × 950 × 950	53 × 950 × 950	53 × 950 × 950	53 × 950 × 950	53 × 950 × 950	53 × 950 × 950	53 × 950 × 950	53 × 950 × 950	53 × 950 × 950
Weight		kg (lbs)	6.0 (13)	6.0 (13)	6.0 (13)	6.0 (13)	6.0 (13)	6.0 (13)	6.0 (13)	6.0 (13)	6.0 (13)	6.0 (13)

*1: IR Receiver kit and Human sensor kit cannot be connected.

Optional parts

* For optional parts compatibility of Inesis devices, refer to the optional parts compatibility list Page C-046.

Compact wired remote controller:	UTY-RCRYZ1	WLAN adapter:	UTY-TFSXZ1	Cassette Grille:	UTG-UKYA-B
Wired remote controller (touch panel):	UTY-RNRYZ5		FJ-RC-WIFI-1		UTG-UKYA-W
Wired remote controller:	UTY-RLRY	External input and output PCB:	UTY-XCSX		UTG-UKYC-W
	UTY-RNNYM	External input and output PCB box:	UTZ-GXRA	Air Outlet Shutter Plate:	UTR-YDZK
	UTY-RVNYM	Insulation kit for high humidity:	UTZ-KXRA	Network Converter for single split (DC power supply type):	UTY-VTGX
	UTY-RHRY	Fresh air intake kit:	UTZ-VXRA	Network Converter for single split (AC power supply type):	UTY-VTGXV
Simple remote controller (without operation mode):	UTY-RSRY	Wide Panel:	UTG-AKXA-W	Silver Ion Filter:	UTD-HFRA
Simple remote controller:	UTY-RSNYM	Panel Spacer:	UTG-BKXA-W		
Human sensor kit:	UTY-SHZXC	IR receiver unit:	UTY-LBXYC	(Outdoor unit 30/36/45/54)	
External switch controller:	UTY-TERX	External connect kit:	UTY-XWZXZG	External connect kit:	UTY-XWZXZ3

Dimensions

(Unit: mm)

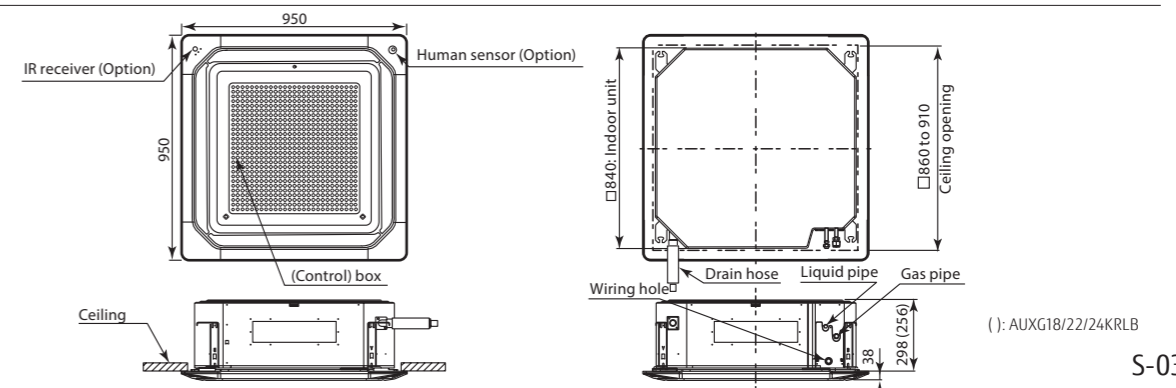

(): AUXG18/22/24KRLB

Slim Duct

Slim Design



Slim design

The slim design fits nicely into narrow spaces under the ceiling. Drain hose as standard accessory



Compact and lightweight outdoor unit

The compact and lightweight outdoor unit offers greater flexibility in the choice of installation location. This makes it easier to use this outdoor unit.



Wide range of static pressures

The use of a DC fan motor makes it possible to adjust the static pressure between 0 and 90 Pa. The static pressure range can be changed by a remote controller.



Static pressure range
0 to 90 Pa

Auto Louver Grille Kit (Option)

The optional clean-looking flat Auto louver blends into any interior and provides a comfortable airflow.



Low ambient operation

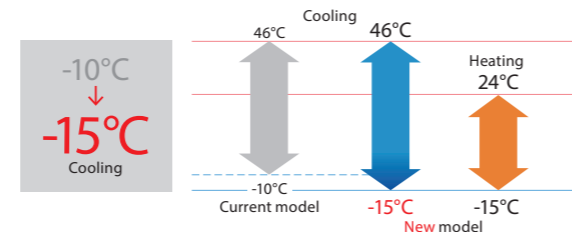

Model: ARXG09KLLAP/ARXG12KLLAP/ARXG14KLLAP/ARXG18KLLAP

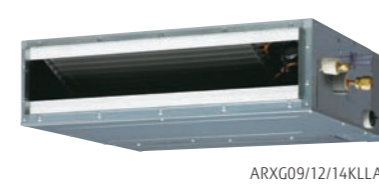

ARXG09/12/14KLLAP

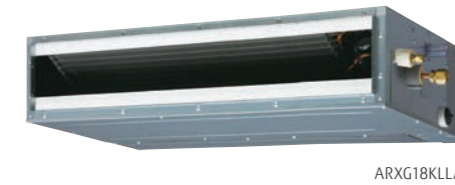

ARXG18KLLAP



For ARXG09/12/14KLLAP For ARXG18KLLAP

Specifications

Model name	Indoor unit		ARXG09KLLAP	ARXG12KLLAP	ARXG14KLLAP	ARXG18KLLAP	
	Outdoor unit		AOYG09KBTB	AOYG12KBTB	AOYG14KBTB	AOYG18KBTB	
Power Source	Single phase, ~230 V, 50 Hz						
Capacity	Cooling	kW	2.5 (0.9-3.2)	3.5 (0.9-4.4)	4.3 (0.9-5.4)	5.2 (0.9-5.9)	
	Heating		3.2 (0.9-4.7)	4.1 (0.9-5.7)	5.0 (0.9-6.5)	6.0 (0.9-7.5)	
Input Power	Cooling/Heating		kW	0.60/0.79	0.93/1.08	1.28/1.32	1.55/1.62
	Cooling	W/W		4.17	3.76	3.36	3.35
EER	Cooling		W/W	4.05	3.80	3.79	3.70
	Heating			4.05	3.80	3.79	3.70
COP	Cooling/Heating (-10°C)		kW	2.5/2.6	3.5/3.4	4.3/3.8	5.2/4.4
	Cooling			W/W	6.20	6.10	5.80
SEER	Cooling		W/W	4.30	4.00	3.90	4.10
	Heating			4.30	4.00	3.90	4.10
SCOP	Cooling		A	A++	A++	A+	A++
	Heating			A+	A+	A	A+
Max. Operating Current	Cooling/Heating		A	7.9/7.9	9.7/9.7	10.2/10.2	12.1/12.1
	Cooling			kWh/a	141	201	259
Annual Energy Consumption	Cooling		kWh/a	845	1,189	1,362	1,501
	Heating			l/h	0.7	1.3	1.5
Moisture Removal	Indoor (Cooling)		H/M/L/Q	28/27/26/25	29/28/26/25	32/30/28/26	32/30/29/27
	Indoor (Heating)			H/M/L/Q	28/26/25/24	29/28/26/24	32/30/28/25
Sound Pressure Level	Outdoor (Cooling/Heating)		dB(A)	46/46	47/47	49/49	50/50
	Indoor (Cooling/Heating)			High	57/57	58/58	60/60
Sound Power Level	Outdoor (Cooling/Heating)		High	59/59	61/61	62/62	62/62
	Indoor (Cooling/Heating)			High	600/1,480	650/1,580	800/1,670
Airflow Rate	Indoor/Outdoor (Cooling)		m³/h	600/1,410	650/1,520	800/1,580	940/1,830
	Indoor/Outdoor (Heating)			High	0 to 90 (25)	0 to 90 (25)	0 to 90 (25)
Static pressure range (Standard)	Indoor		mm	198 × 700 × 620	198 × 700 × 620	198 × 700 × 620	198 × 900 × 620
	Outdoor			mm	542 × 799 × 290	542 × 799 × 290	542 × 799 × 290
Net Dimensions H x W x D	Indoor		kg (lbs)	17 (37)	17 (37)	17 (37)	20 (44)
	Outdoor			kg (lbs)	32 (71)	33 (73)	33 (73)
Weight	Indoor		kg (lbs)	6.35/9.52	6.35/9.52	6.35/9.52	6.35/12.70
	Outdoor			mm	25/32	25/32	25/32
Connection Pipe Diameter (Liquid/Gas)	Indoor		mm	20 (15)	25 (15)	25 (15)	30 (20)
	Outdoor			m	15	20	20
Max. Pipe Length (Pre-Charge)	Cooling		°CDB	-15 to 46	-15 to 46	-15 to 46	-15 to 46
	Heating			-15 to 24	-15 to 24	-15 to 24	-15 to 24
Max. Height Difference	Type (Global Warming Potential)		kg (CO2eq-T)	R32 (675)	R32 (675)	R32 (675)	R32 (675)
	Charge			0.85 (0.574)	0.85 (0.574)	0.85 (0.574)	1.02 (0.689)

Optional parts

* For optional parts compatibility of Intesis devices, refer to the optional parts compatibility list Page C-046.

Compact wired remote controller:	UTY-RCRYZ1	External switch controller:	UTY-TERX	Network Converter for single split (DC power supply type):	UTY-VTGX
Wired remote controller (touch panel):	UTY-RNRYZ5	WLAN adapter:	UTY-TFSXZ1	Network Converter for single split (AC power supply type):	UTY-VTGXV
Wired remote controller:	UTY-RLRY		FJ-RC-WIFI-1	External connect kit:	UTY-XWZXZG
	UTY-RNNYM	Silver Ion Filter:	UTD-HFTA (09-14)	Remote sensor unit:	UTY-XSZX
	UTY-RVNYM		UTD-HFTB (18)	Fresh air intake kit:	UTZ-VXAA
Simple remote controller (without operation mode):	UTY-RHRY	Auto Louver Grille Kit:	UTD-GXTA-W (09-14)		
Simple remote controller:	UTY-RSRY		UTD-GXTB-W (18)		
	UTY-RSNYM	IR receiver unit:	UTY-LBTYM		

Dimensions

(Unit: mm)

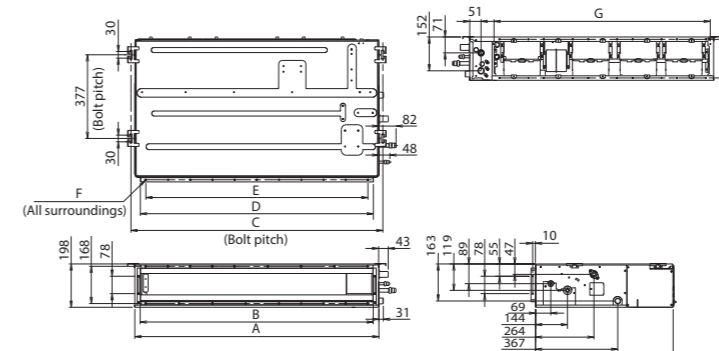

	ARXG09/12/14KLLAP	ARXG18KLLAP
A	700	900
B	650	850
C	734	934
D	650	850
E	P100 × 6 = 600	P100 × 8 = 800
F	18 × Ø5	22 × Ø5
G	574	774

Medium Static Pressure Duct Compact Size



High-Efficiency & Quiet Operation

The combination of the V-shaped heat exchanger, air stabilizer, and the high-efficiency DC fan motor enable high-efficiency and quiet operation.

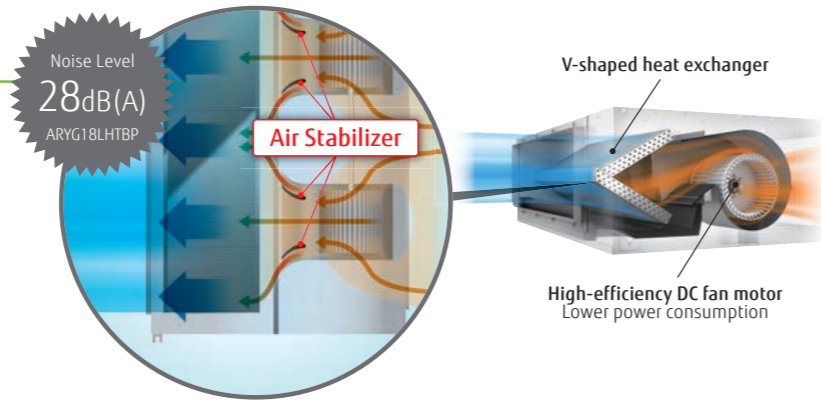

Small, lightweight outdoor unit

The outdoor unit in this series is smaller and lighter than previous-generation outdoor units. It can be installed in a narrow space.

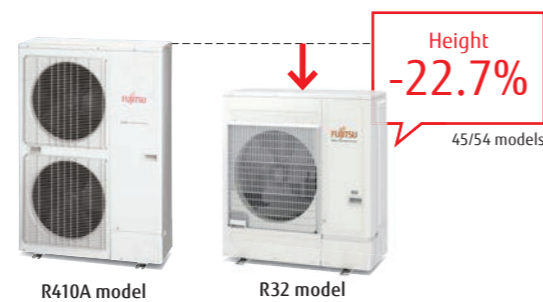

Automatic Airflow adjustment function

This unique and innovative function detects required air flow in each application case and automatically adjust the volume.



Low ambient operation

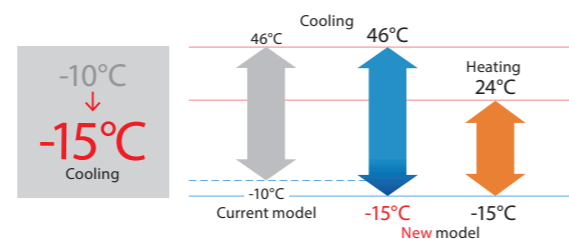

Model: ARXG12KHTAP/ARXG14KHTAP/ARXG18KHTAP/ARXG22KHTAP/ARXG24KHTAP
ARXG30KHTAP/ARXG36KHTAP/ARXG45KHTAP/ARXG54KHTAP
ARXG36KHTAP [3-phase]/ARXG45KHTAP [3-phase]/ARXG54KHTAP [3-phase]



Specifications

Model name	Indoor unit		ARXG12KHTAP	ARXG14KHTAP	ARXG18KHTAP	ARXG22KHTAP	ARXG24KHTAP	ARXG30KHTAP	ARXG36KHTAP	ARXG45KHTAP	ARXG54KHTAP	3-phase, 400 V, 50 Hz			
	Outdoor unit		ADYG12KHTB	ADYG14KHTB	ADYG18KHTB	ADYG22KHTB	ADYG24KHTB	ADYG30KHTB	ADYG36KHTB	ADYG45KHTB	ADYG54KHTB	ADYG36KHTA	ADYG45KHTA	ADYG54KHTA	
Power Source	Single phase, 230 V, 50 Hz											3-phase, 400 V, 50 Hz			
Capacity	Cooling	kW													
	Heating	kW													
Input Power	Cooling/Heating	kW													
		W/W													
EER	Cooling	W/W													
	Heating	W/W													
COP	Cooling	W/W													
	Heating	W/W													
Pdesign	Cooling/Heating (-10°C)	kW													
		W/W													
SEER	Cooling	W/W													
	Heating (Average)	W/W													
SCOP	Cooling	W/W													
	Heating (Average)	W/W													
Energy Efficiency Class	Cooling	A++													
	Heating (Average)	A+													
Max. Operating Current	Cooling/Heating	A													
		kWh/a													
Annual Energy Consumption	Cooling	kWh/a													
	Heating	kWh/a													
Moisture Removal	Cooling	l/h													
	Heating	l/h													
Sound Pressure Level	Indoor (Cooling)	H/M/L/Q													
	Indoor (Heating)	H/M/L/Q													
Sound Power Level	Outdoor (Cooling/Heating)	dB(A)													
		dB(A)													
Airflow Rate	Indoor (Cooling/Heating)	High													
	Indoor/Outdoor (Cooling)	High													
Static pressure range (Standard)	Indoor (Cooling)	Pa													
	Indoor (Heating)	Pa													
Net Dimensions	Indoor	mm													
	Outdoor	mm													
Weight	Indoor	kg (lbs)													
	Outdoor	kg (lbs)													
Connection Pipe Diameter (Liquid/Gas)	Indoor	mm													
	Outdoor	mm													
Drain Hose Diameter (I.D./O.D.)	Indoor	mm													
	Outdoor	mm													
Max. Pipe Length (Pre-Charge)	Cooling	m													
	Heating	m													
Max. Height Difference	Cooling	m													
	Heating	m													
Operating Range	Cooling	°CDB													
	Heating	°CDB													
Refrigerant	Type (Global Warming Potential)	R32 (675)													
	Charge	kg (CO2eq-T)													

Optional parts

Compact wired remote controller:	UTY-RCRYZ1	External input and output PCB:	UTY-XCSX	WLAN adapter:	UTY-TFSXZ1
Wired remote controller (touch panel):	UTY-RNRYZ5	External connect kit:	UTY-XWZXZG		FJ-RC-WIFI-1
Wired remote controller:	UTY-RLRY	External input and output PCB:	UTZ-GXNA	Network Converter for single split (DC power supply type):	UTY-VTGX
	UTY-RNNYM	Long-life filter:	UTD-LFNA (36-54)	Network Converter for single split (AC power supply type):	UTY-VTGXV
	UTY-RVNYM		UTD-LFNB (18-30)		
Simple remote controller (without operation model):	UTY-RHRY	Silver Ion Filter:	UTD-HFNC (12-14)	(Outdoor unit 30/36/45/54)	
Simple remote controller:	UTY-RSRY		UTD-HFNB (18-30)	External connect kit:	UTY-XWZXZ3
	UTY-RSNYM	IR receiver unit:	UTY-LBTYM		
Remote sensor unit:	UTY-XSZX				
External switch controller:	UTY-TERX				

Dimensions

(Unit: mm)

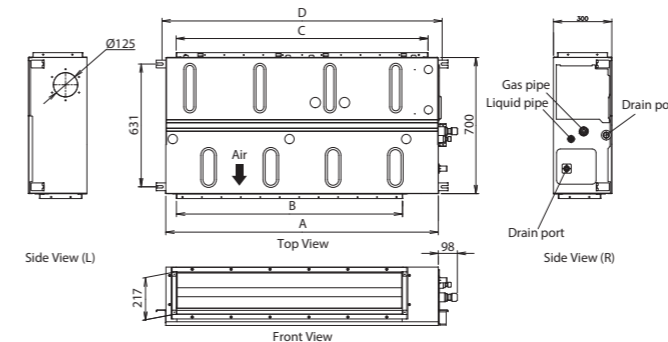

	ARXG12/14KHTAP	ARXG18/22/24/30KHTAP	ARXG36/45/54KHTAP
A	700	1,000	1,400
B	462	762	1,162
C	650	895	1,295
D	740	1,040	1,440

Medium Static Pressure Duct Standard



Model: ARXG22KMLB/ARXG24KMLA/ARXG30KMLA/ARXG36KMLA/ARXG45KMLA
ARXG36KMLA [3-phase]/ARXG45KMLA [3-phase]

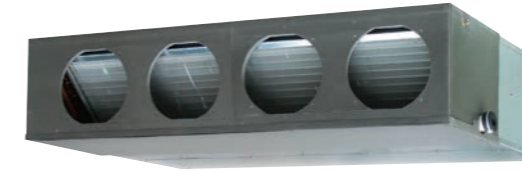

Specifications

Model name	Indoor unit		ARXG22KMLB	ARXG24KMLA	ARXG30KMLA	ARXG36KMLA	ARXG45KMLA	ARXG36KMLA	ARXG45KMLA
	Outdoor unit		AOYG22KBTB	AOYG24KBTB	AOYG30KBTB	AOYG36KBTB	AOYG45KBTB	AOYG36KRTA	AOYG45KRTA
Power Source	Single phase, ~230 V, 50 Hz							3-phase, ~400 V, 50 Hz	
Capacity	Cooling	kW	6.0 (0.9-6.7)	6.8 (0.9-8.0)	8.5 (2.8-10.0)	9.5 (2.8-11.2)	12.1 (4.0-13.0)	9.5 (2.8-11.2)	12.1 (4.0-13.0)
	Heating		7.0 (0.9-8.0)	7.5 (0.9-9.1)	10.0 (2.7-11.2)	10.8 (2.7-12.7)	13.5 (4.2-15.2)	10.8 (2.7-12.7)	13.5 (4.2-15.2)
Input Power	Cooling/Heating	kW	1.78/1.87	2.14/1.97	2.65/2.63	2.97/2.88	4.22/3.84	2.97/2.88	4.22/3.84
	Cooling		3.37	3.18	3.21	3.20	2.87	3.20	2.87
EER	Cooling	W/W	3.74	3.80	3.80	3.75	3.52	3.75	3.52
	Heating		3.74	3.80	3.80	3.75	3.52	3.75	3.52
Pdesign	Cooling/Heating (-10°C)	kW	6.0/4.8	6.8/6.0	8.5/8.0	9.5/8.7	-	9.5/8.7	-
	Cooling		6.10	6.20	6.23	6.10	-	6.10	-
SEER	Cooling	W/W	4.10	4.10	4.00	4.00	-	4.00	-
	Heating		4.10	4.10	4.00	4.00	-	4.00	-
SCOP	Cooling	A	A++	A++	A++	A++	-	A++	-
	Heating		A+	A+	A+	A+	-	A+	-
Max. Operating Current	Cooling/Heating	A	12.6/12.6	13.6/13.6	22.6/22.6	22.6/22.6	28.5/28.5	10.5/10.5	14.0/14.0
	Cooling		344	384	477	545	-	545	-
Annual Energy Consumption	Cooling	kWh/a	1.637	2.045	2.797	3.044	-	3.044	-
	Heating		2.1	2.5	2.5	3.0	4.0	3.0	4.0
Moisture Removal	Indoor (Cooling)	l/h	31/29/27/25	31/29/27/25	39/35/30/26	39/35/30/26	42/38/32/28	39/35/30/26	42/38/32/28
	Indoor (Heating)		31/29/27/25	31/29/27/25	42/35/30/26	42/35/30/26	42/35/30/28	42/35/30/26	42/38/32/28
Sound Pressure Level	Outdoor (Cooling/Heating)	dB(A)	51/51	53/54	53/55	55/55	57/57	55/55	57/57
	Indoor (Cooling/Heating)		60/62	60/62	65/69	65/70	68/70	65/70	68/70
Sound Power Level	Outdoor (Cooling/Heating)	High	63/63	65/66	68/69	70/70	71/71	70/70	71/71
	Indoor (Cooling/Heating)		63/63	65/66	68/69	70/70	71/71	70/70	71/71
Airflow Rate	Indoor/Outdoor (Cooling)	m³/h	1,100/2,240	1,100/2,700	1,900/3,750	1,900/3,750	2,100/4,450	1,900/3,750	2,100/4,450
	Indoor/Outdoor (Heating)		1,100/1,960	1,100/2,700	2,100/3,750	2,100/3,750	2,100/4,450	2,100/3,750	2,100/4,450
Static pressure range (Standard)	Indoor	Pa	30 to 150 (35)	30 to 150 (35)	30 to 150 (47)	30 to 150 (47)	30 to 150 (60)	30-150 (47)	30-150 (60)
	Outdoor		270 × 1,135 × 700	270 × 1,135 × 700	270 × 1,135 × 700	270 × 1,135 × 700	270 × 1,135 × 700	270 × 1,135 × 700	270 × 1,135 × 700
Net Dimensions H x W x D	Indoor	mm	632 × 799 × 290	716 × 820 × 315	788 × 940 × 320	788 × 940 × 320	998 × 940 × 320	788 × 940 × 320	998 × 940 × 320
	Outdoor		35 (77)	35 (77)	38 (84)	38 (84)	39 (86)	38 (84)	39 (86)
Weight	Indoor	kg (lbs)	38 (84)	42 (93)	52 (115)	52 (115)	67 (148)	53 (117)	67 (148)
	Outdoor		6.35/12.70	6.35/12.70	9.52/15.88	9.52/15.88	9.52/15.88	9.52/15.88	9.52/15.88
Connection Pipe Diameter (Liquid/Gas)	Indoor	mm	35.7/38.1	35.7/38.1	35.7/38.1	35.7/38.1	35.7/38.1	35.7/38.1	35.7/38.1
	Outdoor		30 (20)	30 (20)	50 (30)	50 (30)	50 (30)	50 (30)	50 (30)
Max. Pipe Length (Pre-Charge)	Cooling	m	25	25	30	30	30	30	30
	Heating		-15 to 46	-15 to 46	-15 to 24	-15 to 46	-15 to 46	-15 to 24	-15 to 46
Operating Range	Cooling	°CDB	-15 to 24	-15 to 24	-15 to 24	-15 to 24	-15 to 24	-15 to 24	-15 to 24
	Heating		25	25	30	30	30	30	30
Refrigerant	Type (Global Warming Potential)	kg (CO2eq-T)	R32 (675)	R32 (675)	R32 (675)	R32 (675)	R32 (675)	R32 (675)	R32 (675)
	Charge		1.25 (0.844)	1.25 (0.844)	1.90 (1.283)	1.90 (1.283)	2.70 (1.823)	1.90 (1.283)	2.70 (1.823)

Slim & Compact Design

Indoor Unit

The slim and compact design of the indoor unit, with the control box mounted on the side, allows installation in narrow spaces.

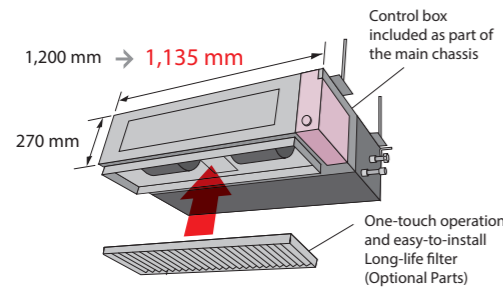

Outdoor Unit

The outdoor units for the 45,000 BTU and 54,000 BTU models have been completely redesigned. Easier installation is achieved for this compact and lightweight outdoor unit.

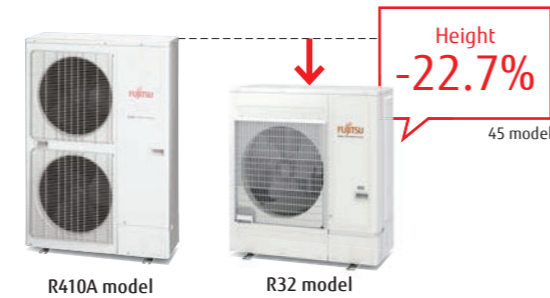

Easy maintenance

Structural improvement is attained by making the bottom panel in two pieces—front and rear. The internal fan casing is also manufactured in two pieces—upper and lower. As a result, the motor and fan can be easily accessed and maintained by removing the rear panel and the lower casing while leaving the main chassis in place.

See below for case of rear-suction type

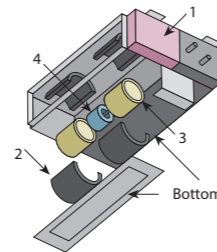

- Control box
- Fan casing
- Fan
- Motor

Two-direction drain piping

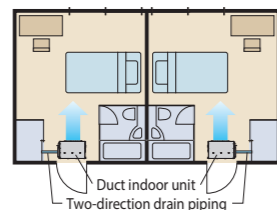

All class low ambient operation

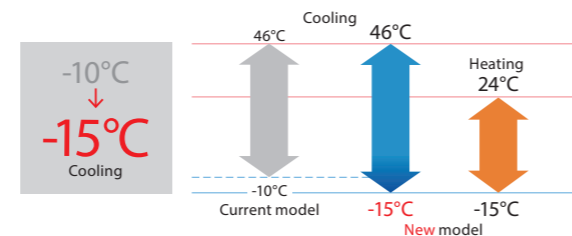

Optional parts

* For optional parts compatibility of Intesis devices, refer to the optional parts compatibility list Page C-046.

Compact wired remote controller:	UTY-RCRYZ1	External switch controller:	UTY-TERX	Network Converter for single split (DC power supply type):	UTY-VTGX
Wired remote controller (touch panel):	UTY-RNRYZ5	WLAN adapter:	UTY-TFSXZ1	Network Converter for single split (AC power supply type):	UTY-VTGXV
Wired remote controller:	UTY-RLRY		FJ-RC-WIFI-1	Drain pump unit:	UTZ-PXINBA
	UTY-RNNYM	Flange (Round):	UTD-RF204	Long-life filter:	UTD-LF25NA
	UTY-RVNYM	Flange (Square):	UTD-SF045T	Silver Ion Filter:	UTD-HFND
Simple remote controller (without operation mode):	UTY-RHRY	IR receiver unit:	UTY-LBTYM		
Simple remote controller:	UTY-RSRY	Remote sensor unit:	UTY-XSZX	(Outdoor unit 30/36/45/54)	
	UTY-RSNYM	External connect kit:	UTY-XWZXZG	External connect kit:	UTY-XWZXZ3

Dimensions

(Unit: mm)

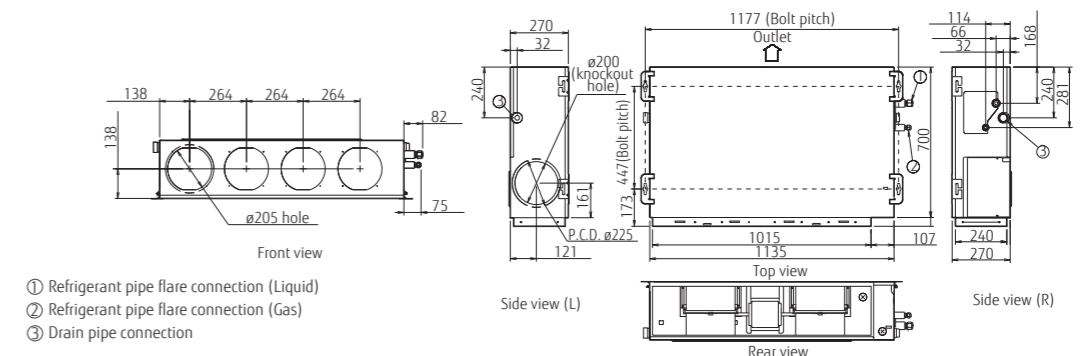

High Static Pressure Duct



Easy installation (Compact & Lightweight)

The indoor and outdoor units are designed to be compact and light by reducing the basic chassis size and the overall material weight.

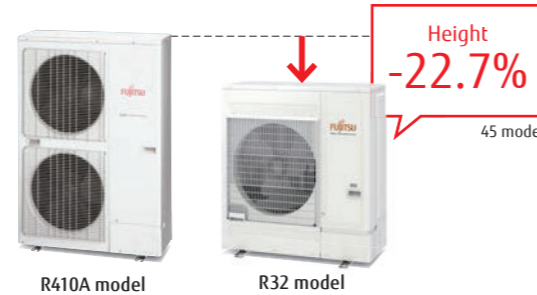
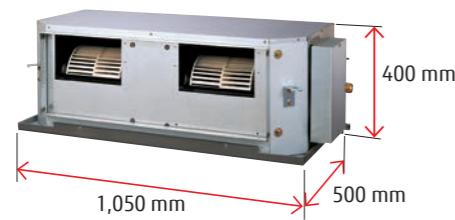

Design also suits high static pressure

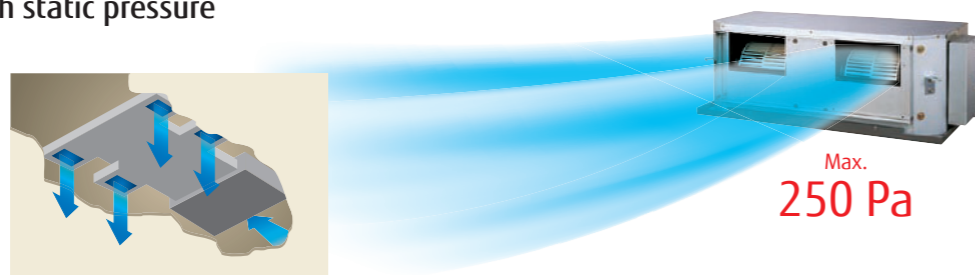

Low noise

Slanted corners at the top help reduce turbulent airflow. Low noise is realized by adopting a plastic case and a plastic fan.

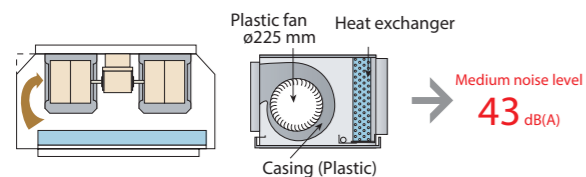

Low ambient operation

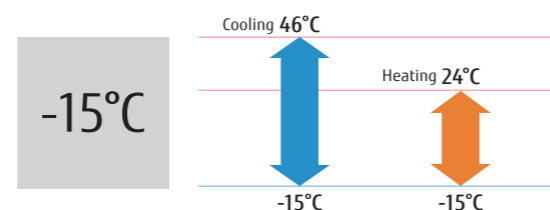

Model: ARXG45KHTA/ARXG54KHTA
ARXG45KHTA [3-phase]/ARXG54KHTA [3-phase]



Specifications

Model name	Indoor unit		ARXG45KHTA	ARXG54KHTA	ARXG45KHTA	ARXG54KHTA
	Outdoor unit		AOYG45KBTB	AOYG54KBTB	AOYG45KRTA	AOYG54KRTA
Power Source	Single phase, ~230 V, 50 Hz			3-phase, ~400 V, 50 Hz		
Capacity	Cooling	kW	12.1 (4.0-14.0)	13.4 (5.0-14.5)	12.1 (4.0-14.0)	13.4 (5.0-14.5)
	Heating		13.5 (5.0-16.2)	15.5 (5.5-18.0)	13.5 (5.0-16.2)	15.5 (5.5-18.0)
Input Power	Cooling/Heating		4.16/3.61	4.77/4.18	4.16/3.61	4.77/4.18
	EER	Cooling	2.91	2.81	2.91	2.81
COP		Heating	3.74	3.71	3.74	3.71
	Pdesign	Cooling/Heating (-10°C)		-	-	-
SEER		Cooling	-	-	-	-
	SCOP	Heating	-	-	-	-
Energy Efficiency Class		Cooling		-	-	-
	Heating		-	-	-	-
Max. Operating Current	Cooling/Heating		28.5/28.5	28.5/28.5	14.0/14.0	14.0/14.0
	Annual Energy Consumption	Cooling	-	-	-	-
Heating		-	-	-	-	
Moisture Removal	l/h		1.5	2.0	1.5	2.0
	Sound Pressure Level	Indoor (Cooling)	H/M/L	47/43/40	47/43/40	47/43/40
Indoor (Heating)		H/M/L	47/43/40	47/43/40	47/43/40	47/43/40
Sound Power Level	Outdoor (Cooling/Heating)	High	57/57	57/59	57/57	57/59
	Indoor (Cooling/Heating)	High	75/74	75/74	75/74	75/74
Airflow Rate	Outdoor (Cooling/Heating)	High	71/71	73/73	71/71	73/73
	Indoor/Outdoor (Cooling)	High	3,350/4,450	3,350/4,450	3,350/4,450	3,350/4,450
Static pressure range (Standard)	Pa		100 to 250 (100)	100 to 250 (100)	100to250 (100)	100to250 (100)
	Net Dimensions		400 × 1,050 × 500	400 × 1,050 × 500	400 × 1,050 × 500	400 × 1,050 × 500
H x W x D	Indoor	mm	998 × 940 × 320	998 × 940 × 320	998 × 940 × 320	998 × 940 × 320
	Outdoor	mm	998 × 940 × 320	998 × 940 × 320	998 × 940 × 320	998 × 940 × 320
Weight	Indoor	kg (lbs)	46 (101)	46 (101)	46 (101)	46 (101)
	Outdoor	kg (lbs)	67 (148)	67 (148)	67 (148)	67 (148)
Connection Pipe Diameter (Liquid/Gas)	mm		9.52/15.88	9.52/15.88	9.52/15.88	9.52/15.88
	Drain Hose Diameter (I.D./O.D.)		23.4/25.4	23.4/25.4	23.4/25.4	23.4/25.4
Max. Pipe Length (Pre-Charge)	m		50 (30)	50 (30)	50 (30)	50 (30)
	Max. Height Difference		30	30	30	30
Operating Range	Cooling	°CDB	-15 to 46	-15 to 46	-15 to 46	-15 to 46
	Heating	°CDB	-15 to 24	-15 to 24	-15 to 24	-15 to 24
Refrigerant	Type (Global Warming Potential)		R32 (675)	R32 (675)	R32 (675)	R32 (675)
	Charge	kg (CO2eq-T)	2.70 (1.823)	2.70 (1.823)	2.70 (1.823)	2.70 (1.823)

Optional parts

* For optional parts compatibility of Intesis devices, refer to the optional parts compatibility list Page C-046.

Wired remote controller: UTY-RNNYM	External connect kit: UTD-ECSSA	Network Converter for single split (DC power supply type): UTY-VTGX
UTY-RVNYM	Remote sensor unit: UTY-XS2X	Network Converter for single split (AC power supply type): UTY-VTGXV
Simple remote controller: UTY-RSNYM	Long-life filter: UTD-LF60KA	
WLAN adapter: UTY-TFNXZ1	External switch controller: UTY-TERX	(Outdoor unit 45/54) UTY-XWZ23
FJ-RC-WIFI-1	Silver Ion Filter: UTD-HFKB	External connect kit:

Dimensions

(Unit: mm)

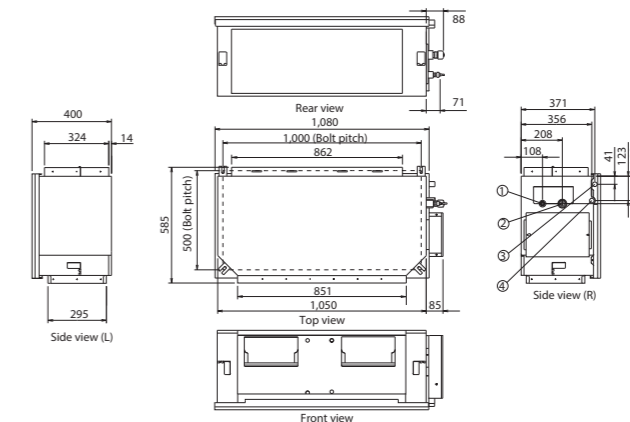

- ① Refrigerant pipe flare connection (Liquid)
- ② Refrigerant pipe flare connection (Gas)
- ③ Drain pipe connection (Safety drain pan)
- ④ Drain pipe connection (Main drain pan)

High Static Pressure Duct



Model: ARYG60LHTA [3-phase]



Specifications

Model name	Indoor unit		ARYG60LHTA	
	Outdoor unit		AOYG60LATT	
Power Source			3-phase, ~400 V, 50 Hz	
Capacity	Cooling	kW	15.0 (6.2-17.5)	
	Heating	kW	18.0 (6.2-20.0)	
Input Power	Cooling/Heating		kW	
EER	Cooling		W/W	
COP	Heating		W/W	
Max. Operating Current	Cooling/Heating		A	
Moisture Removal			l/h	
Sound Pressure	Indoor (Cooling)	H/M/L/Q	dB(A)	
	Indoor (Heating)	H/M/L/Q	45/40/36/-	
	Outdoor (Cooling/Heating)	High	56/58	
Airflow Rate	Indoor/Outdoor (Cooling)	High	m³/h	
	Indoor/Outdoor (Heating)	High	3,550/6,900 3,550/7,300	
Static pressure range (Standard)			Pa	
Net Dimensions H x W x D	Indoor	mm	425 x 1,250 x 490	
	Outdoor	mm	1,290 x 900 x 330	
Weight	Indoor	kg (lbs)	54 (119)	
	Outdoor	kg (lbs)	104 (229)	
Connection Pipe Diameter (Liquid/Gas)			mm	
Drain Hose Diameter (I.D./O.D.)			mm	
Max. Pipe Length (Pre-Charge)			m	
Max. Height Difference			m	
Operating Range	Cooling	°CDB	-15 to 46	
	Heating	°CDB	-15 to 24	
Refrigerant	Type (Global Warming Potential)		R410A (2,088)	
	Charge	kg (CO2eq-T)	3.45 (7.204)	

High energy efficiency

Much greater efficiency is achieved by the use of all-DC inverter technology. (60 model)

Design also corresponding to high static pressure

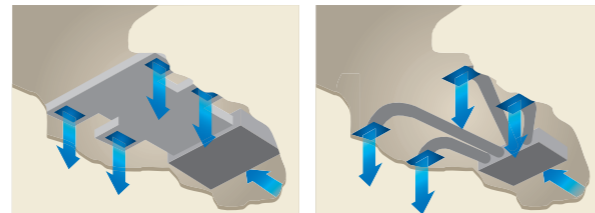
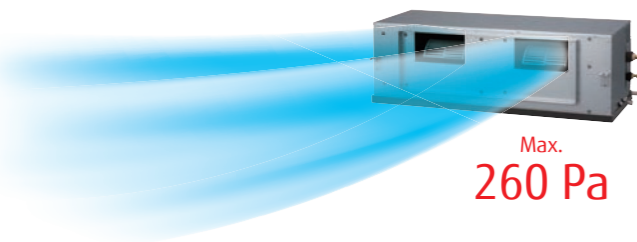

Easy installation (Compact & Lightweight)

The indoor unit is designed to be compact and light by reducing the basic chassis size and the overall material weight.

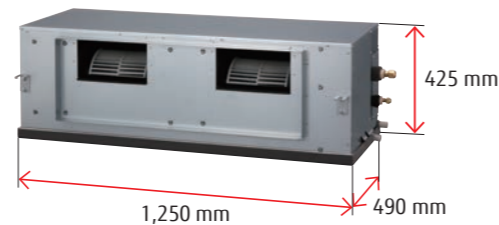

Low noise

Slanted corners at the top help reduce turbulent airflow. Low noise is realized by adopting a plastic case and a plastic fan.

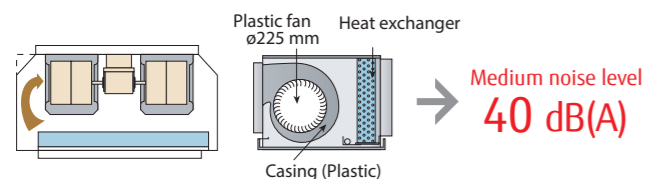

Low ambient operation

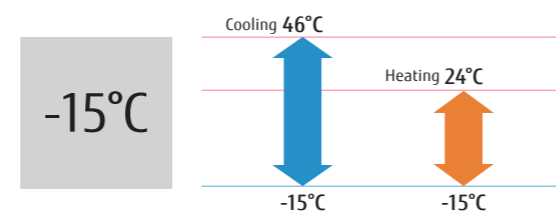

Optional parts

* For optional parts compatibility of Intesis devices, refer to the optional parts compatibility list Page C-046.

Wired remote controller:	UTY-RNNYM	Network Converter for single split (DC power supply type):	UTY-VTGX
Wired remote controller:	UTY-RVNYM	Network Converter for single split (AC power supply type):	UTY-VTGXV
Simple remote controller:	UTY-RSNYM	External connect kit:	UTD-ECSSA
External switch controller:	UTY-TERX	IR receiver unit:	UTY-LRHYM
WLAN adapter:	UTY-TFNXZ1		
	FJ-RC-WIFI-1	(Outdoor unit AOYG60LATT)	
Remote sensor unit:	UTY-XSZX	External connect kit:	UTY-XWZXZ2

Dimensions

(Unit: mm)

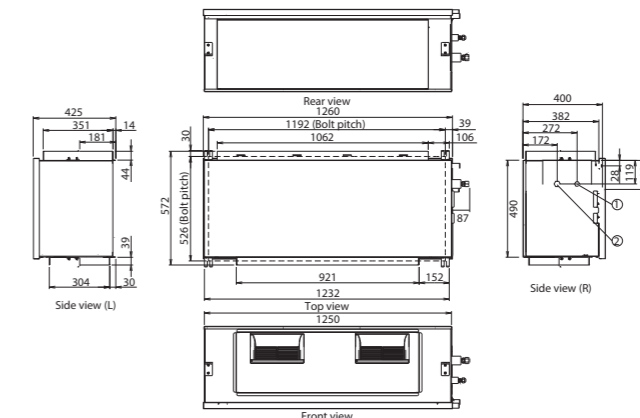

- ① Refrigerant pipe flare connection (Liquid)
- ② Refrigerant pipe flare connection (Gas)
- ③ Drain pipe connection (Safety drain pan)
- ④ Drain pipe connection (Main drain pan)

Big Duct



Model: ARYG72LHTA/ARYG90LHTA



Wired RC



Specifications

Model name	Indoor unit		ARYG72LHTA	ARYG90LHTA
	Outdoor unit		AOYG72LRLA	AOYG90LRLA
Power Source	Indoor		Single phase, ~230 V, 50 Hz	
	Outdoor		3-phase, ~400 V, 50 Hz	
Capacity	Cooling	kW	19.0 (8.4-20.9)	22.0 (10.3-24.2)
	Heating		22.4 (7.2-24.6)	27.0 (8.5-29.7)
Input Power	Cooling/Heating	kW	6.46/6.59	7.77/8.18
	Cooling		2.94	2.83
EER	Cooling	W/W	3.40	3.30
	Heating		-	-
COP	Cooling	A	-	-
	Heating		-	-
Max. Operating Current	Indoor (Cooling/Heating)	A	-	-
	Outdoor (Cooling/Heating)		-	-
Moisture Removal			4.5	6.0
	Indoor (Cooling)	H/M/L/Q	46/43/41/39	47/44/42/40
Sound Pressure	Indoor (Heating)	H/M/L/Q	46/43/41/39	47/44/42/40
	Outdoor (Cooling/Heating)	High	55/55	55/57
Airflow Rate	Indoor/Outdoor (Cooling)	High	4,300/8,400	4,300/8,400
	Indoor/Outdoor (Heating)	High	4,300/8,400	4,300/9,000
Static pressure range (Standard)		Pa	50 to 150 (72)	50 to 200 (72)
Net Dimensions	Indoor	mm	360 × 1,400 × 850	360 × 1,400 × 850
	Outdoor	mm	1,428 × 1,080 × 480	1,428 × 1,080 × 480
Weight	Indoor	kg (lbs)	69 (152)	80 (176)
	Outdoor	kg (lbs)	165 (364)	174 (384)
Connection Pipe Diameter (Liquid/Gas)		mm	12.7/25.4	12.7/25.4
Drain Hose Diameter (I.D./O.D.)			25/32	25/32
Max. Pipe Length (Pre-Charge)		m	100 (30)	100 (30)
Max. Height Difference			30	30
Operating Range	Cooling	*CDB	-15 to 46	-15 to 46
	Heating		-20 to 24	-20 to 24
Refrigerant	Type (Global Warming Potential)		R410A (2,088)	R410A (2,088)
	Charge	kg (CO2eq-T)	5.6 (11.693)	7.1 (14.825)

Splittable, lightweight, and compact design

The indoor unit can be split into a fan unit and a heat exchanger unit to make installation easier.

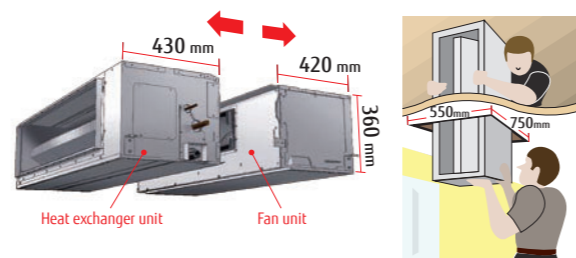

Automatic Airflow adjustment function

The optimum airflow can be set automatically to facilitate faster installation.



Quiet operation

The combination of a V-shaped heat exchanger, an air stabilizer, and a high-efficiency DC fan motor enables this compact unit to operate quietly.

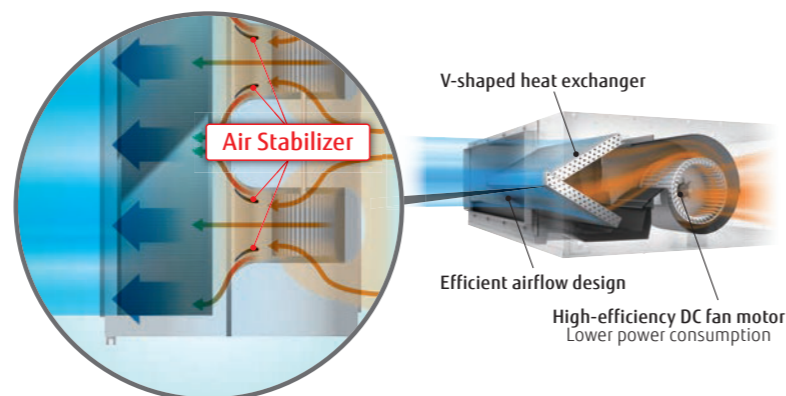

Optional parts

* For optional parts compatibility of Intesis devices, refer to the optional parts compatibility list Page C-046.

Compact wired remote controller:	UTY-RCRYZ1	External switch controller:	UTY-TERX	Network Converter for single split (DC power supply type):	UTY-VTGX
Wired remote controller (touch panel):	UTY-RNRYZ5	WLAN adapter:	UTY-TFSXZ1	Network Converter for single split (AC power supply type):	UTY-VTGXV
Wired remote controller:	UTY-RLRY		FJ-RC-WIFI-1	IR receiver unit:	UTY-LBTYM
	UTY-RNNYM	External input and output PCB:	UTY-XCSX	Silver Ion Filter:	UTY-LRHYM
	UTY-RVNYM	Remote sensor unit:	UTY-XSZX		UTD-HFKA
Simple remote controller (without operation mode):	UTY-RHRY	Long-life filter	UTD-LFKA		
Simple remote controller:	UTY-RSRY	External connect kit:	UTY-XWZXZG	(Outdoor unit 72/90)	
	UTY-RSNYM	Drain pump unit:	UTZ-PXINAB	External connect kit:	UTY-XWZXZ3

Dimensions

(Unit: mm)

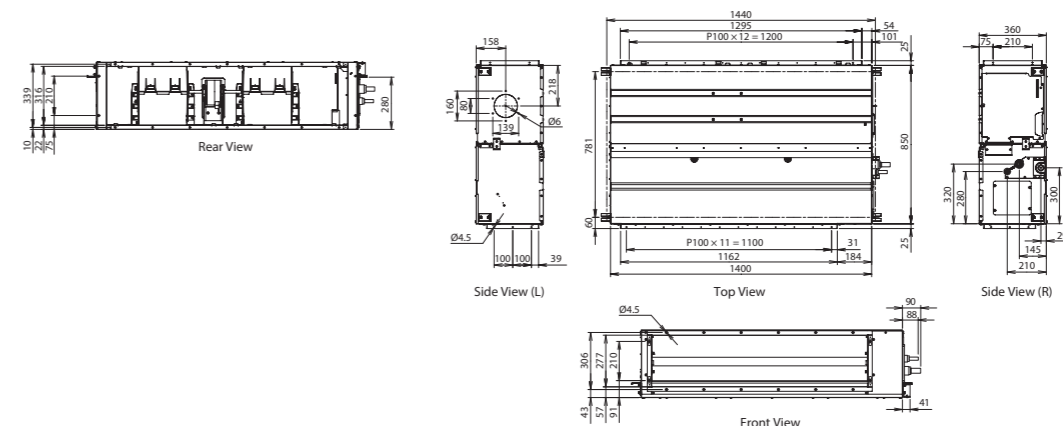

Floor Compact Size



High energy saving

The Floor 09 class achieves a top-class SEER of 8.50 and an A+++ seasonal efficiency rank for cooling. The Floor 09 class achieves an improved SCOP of 4.30 and an A+ seasonal efficiency rank for heating.

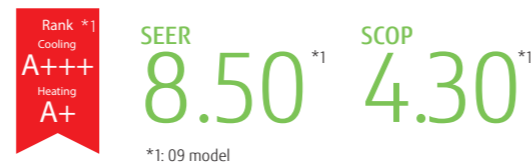

Flexible & easy installation

The compact and whole-surface suction design provides flexible installation options, including floor-standing, embedded, half concealed, and wall mount installation to match the room layout.

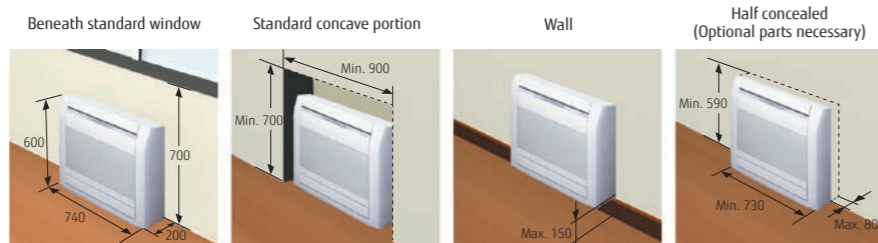

* Concaved position installation with concealment is prohibited.

Low ambient operation

Factory-guaranteed cooling operation down to -10°C ambient temperature.

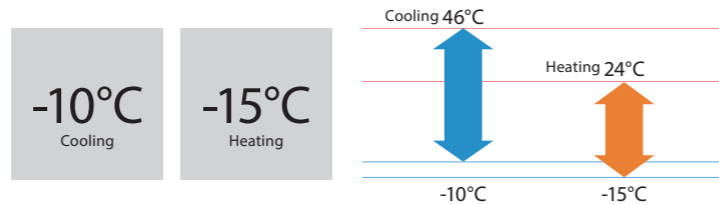

Smart device Control (Option)

With the optional WLAN adapter installed in the air conditioner, you can control it from anywhere with your smart device. WLAN adapter can be installed easily without specialized installation work.



10°C Heat

The room temperature can be set to go no lower than 10°C, thus ensuring that the room does not get too cold when not occupied.

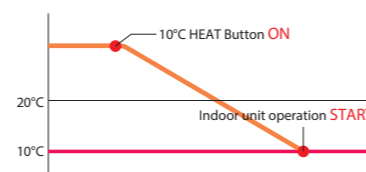

Model: AGYG09KVCA/AGYG12KVCA/AGYG14KVCA



Specifications

Model name	Indoor unit		AGYG09KVCA	AGYG12KVCA	AGYG14KVCA
	Outdoor unit		AOYG09KVCA	AOYG12KVCA	AOYG14KVCA
Power Source	Single phase, ~230 V, 50 Hz				
Capacity	Cooling	kW	2.5 (0.9-3.5)	3.5 (0.9-4.0)	4.2 (0.9-5.2)
	Heating	kW	3.5 (0.9-5.1)	4.5 (0.9-5.3)	5.2 (0.9-6.3)
Input Power	Cooling/Heating		0.53/0.81	0.88/1.22	1.06/1.41
	Cooling	W/W	4.70	4.00	3.95
COP	Heating		4.30	3.70	3.70
	Cooling/Heating (-10°C)	kW	2.50/2.60	3.50/3.50	4.20/4.20
SEER	Cooling	W/W	8.50	8.20	8.10
SCOP	Heating (Average)		4.30	4.10	4.00
	Cooling		A+++	A++	A++
Energy Efficiency Class	Heating (Average)		A+	A+	A+
	Cooling/Heating	A	7.0/8.5	7.0/8.5	11.0/12.0
Max. Operating Current	Cooling		103	149	181
	Heating (Average)		845	1,192	1,466
Annual Energy Consumption	Cooling		1.3	1.8	2.1
	Heating				
Moisture Removal	Indoor (Cooling)	H/M/L/Q	40/35/29/22	40/35/29/22	44/38/31/22
	Indoor (Heating)	H/M/L/Q	41/35/29/22	41/35/29/22	43/37/29/22
Sound Pressure Level	Outdoor (Cooling/Heating)	High	43/47	45/51	51/50
	Indoor (Cooling/Heating)	High	53/54	53/54	57/56
Sound Power Level	Outdoor (Cooling/Heating)	High	58/61	61/64	63/63
	Indoor/Outdoor (Cooling)	High	570/1,530	570/1,530	650/2,210
Airflow Rate	Indoor/Outdoor (Heating)	High	600/1,510	600/1,510	650/2,100
	Indoor	mm	600 × 740 × 200	600 × 740 × 200	600 × 740 × 200
Net Dimensions H x W x D	Outdoor	mm	542 × 799 × 290	542 × 799 × 290	632 × 799 × 290
	Indoor	kg (lbs)	14 (31)	14 (31)	14 (31)
Weight	Indoor	kg (lbs)	31 (68)	31 (68)	38 (83)
	Outdoor	kg (lbs)	6.35/9.52	6.35/9.52	6.35/9.52
Connection Pipe Diameter (Liquid/Gas)	mm	13.8/15.8 to 16.7	13.8/15.8 to 16.7	13.8/15.8 to 16.7	
Drain Hose Diameter (I.D./O.D.)	m	20 (15)	20 (15)	20 (15)	
Max. Pipe Length (Pre-Charge)		15	15	15	
Max. Height Difference	Cooling	°CDB	-10 to 46	-10 to 46	-10 to 46
	Heating	°CDB	-15 to 24	-15 to 24	-15 to 24
Operating Range	Type (Global Warming Potential)		R32 (675)	R32 (675)	R32 (675)
	Charge	kg (CO2eq-T)	0.85 (0.574)	0.85 (0.574)	0.94 (0.635)

Optional parts

* For optional parts compatibility of Intesis devices, refer to the optional parts compatibility list Page C-046.

Compact wired remote controller:	UTY-RCRYZ1	External switch controller:	UTY-TERX	Network Converter for single split (DC power supply type):	UTY-VTGX
Wired remote controller (touch panel):	UTY-RNRYZ5	WLAN adapter:	UTY-TFSXZ1	Network Converter for single split (AC power supply type):	UTY-VTGXV
Wired remote controller:	UTY-RLRY	Half concealed kit:	UTR-STA	Silver Ion Filter:	UTR-FA03-5
Simple remote controller (without operation mode):	UTY-RHRY	Communication kit:	UTY-TWRXZ3		
Simple remote controller:	UTY-RSRY	External connect kit:	UTY-XWXZ5		

Dimensions

(Unit: mm)

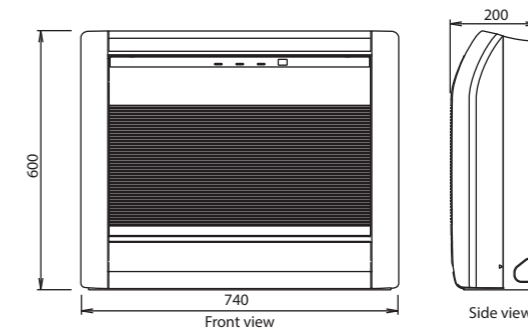

Ceiling



Light Elegant Design

The light-elegant, gently curved surface gives a sense of comfort and well-being.



Flexible installation

The drain hose and pipe can be contained in the casing and connected in the right, left, angled, or downward direction.



Easy installation

The indoor unit can be easily installed under the ceiling thanks to the uniquely designed mounting kit.

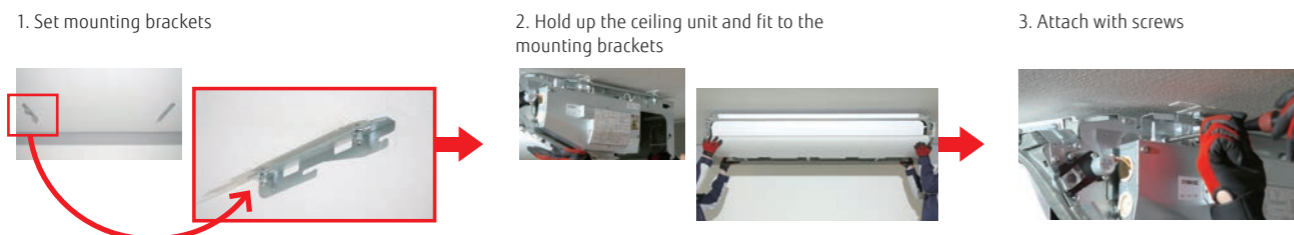

Easy maintenance

The front panel can be opened without removing it for safe & speedy maintenance.

The drain pan can be removed for cleaning.

Components in the control box can be easily accessed from the wide side opening.



Model: **ABYG18KRTA/ABYG22KRTA/ABYG24KRTA/ABYG30KRTA/ABYG36KRTA/ABYG45KRTA/ABYG36KRTA [3-phase] /ABYG45KRTA [3-phase] /ABYG54KRTA [3-phase]**



Specifications

Model name	Indoor unit		Outdoor unit						3-phase, ~400 V, 50 Hz			
	Outdoor unit		ADYG18KBTB	ADYG22KBTB	ADYG24KBTB	ADYG30KBTB	ADYG36KBTB	ADYG45KBTB	ADYG36KRTA	ADYG45KRTA	ADYG54KRTA	
Power Source			Single phase, ~230 V, 50 Hz						3-phase, ~400 V, 50 Hz			
Capacity	Cooling	kW	5.2 (0.9-5.9)	6.0 (0.9-6.7)	6.8 (0.9-8.0)	8.5 (2.8-10.0)	9.5 (2.8-11.2)	12.1 (4.0-13.5)	9.5 (2.8-11.2)	12.1 (4.0-13.5)	13.4 (4.5-14.5)	
	Heating		6.0 (0.9-7.5)	7.0 (0.9-8.0)	7.5 (0.9-9.1)	10.0 (2.7-11.2)	10.8 (2.7-12.7)	13.5 (4.2-16.2)	10.8 (2.7-12.7)	13.5 (4.2-16.2)	15.5 (4.7-16.5)	
Input Power	Cooling/Heating		kW	1.55/1.62	1.87/1.95	2.14/1.97	2.65/2.77	2.96/2.88	4.22/3.84	2.96/2.88	4.22/3.84	4.45/4.43
	Cooling			W/W	3.35	3.21	3.18	3.21	3.21	2.87	3.21	2.87
EER	Cooling		W/W		3.35	3.21	3.18	3.21	3.21	2.87	3.21	2.87
	Heating			3.70	3.59	3.81	3.61	3.75	3.52	3.75	3.52	3.50
Pdesign	Cooling/Heating (-10°C)		kW	5.2/4.4	6.0/4.8	6.8/6.0	8.5/8.0	9.5/8.7	-	9.5/8.7	-	-
SEER	Cooling			W/W	6.2	6.1	6.2	6.1	6.37	-	6.37	-
	Heating (Average)		4.1		4.0	4.1	4.0	4.21	-	4.21	-	-
Energy Efficiency Class	Cooling		A	A++	A++	A++	A++	A++	-	A++	-	-
	Heating (Average)			A+	A+	A+	A+	A+	-	A+	-	-
Max. Operating Current	Cooling/Heating		A	12.1/12.1	12.6/12.6	13.6/13.6	22.6/22.6	22.6/22.6	28.5/28.5	10.5/10.5	14.0/14.0	14.0/14.0
	Cooling			kWh/a	293	344	384	486	524	-	524	-
Annual Energy Consumption	Heating		kWh/a		1,501	1,677	2,042	2,796	2,904	-	2,904	-
	Moisture Removal			l/h	2.0	2.5	2.2	3.0	2.6	4.5	2.6	4.5
Sound Pressure Level	Indoor (Cooling)	H/M/L/Q	dB(A)		38/36/33/31	42/37/34/31	41/36/32/29	45/40/35/32	44/40/37/32	45/41/39/34	44/40/37/32	45/41/39/34
	Indoor (Heating)			H/M/L/Q	38/36/33/31	42/37/34/31	41/36/32/29	45/40/35/32	44/40/37/32	45/41/39/34	44/40/37/32	45/41/39/34
Sound Power Level	Outdoor (Cooling/Heating)	High	dB(A)	50/50	51/51	53/54	53/55	55/55	57/57	55/55	57/57	57/59
	Indoor (Cooling/Heating)			High	53/53	57/57	56/56	60/60	59/59	60/60	59/59	60/60
Airflow Rate	Outdoor (Cooling/Heating)	High	m³/h	62/62	63/63	65/66	68/69	70/70	71/71	70/70	71/71	73/73
	Indoor/Outdoor (Cooling)			High	840/2,160	900/2,240	1,230/2,700	1,400/3,750	1,850/3,750	1,900/4,450	1,850/3,750	1,900/4,450
Net Dimensions H x W x D	Indoor		mm	235 × 1,080 × 705	235 × 1,080 × 705	235 × 1,390 × 705	235 × 1,390 × 705	235 × 1,700 × 705	235 × 1,700 × 705	235 × 1,700 × 705	235 × 1,700 × 705	235 × 1,700 × 705
	Outdoor			632 × 799 × 290	632 × 799 × 290	716 × 820 × 315	788 × 940 × 320	788 × 940 × 320	998 × 940 × 320	788 × 940 × 320	998 × 940 × 320	998 × 940 × 320
Weight	Indoor		kg (lbs)	24 (53)	24 (53)	31 (68)	31 (68)	38 (84)	38 (84)	38 (84)	38 (84)	38 (84)
	Outdoor			36 (79)	38 (84)	42 (93)	52 (115)	52 (115)	67 (148)	53 (117)	67 (148)	67 (148)
Connection Pipe Diameter (Liquid/Gas)			mm	6.35/12.7	6.35/12.7	6.35/12.7	9.52/15.88	9.52/15.88	9.52/15.88	9.52/15.88	9.52/15.88	9.52/15.88
	Drain Hose Diameter (I.D./O.D.)			25/32	25/32	25/32	25/32	25/32	25/32	25/32	25/32	25/32
Max. Pipe Length (Pre-Charge)			m	30 (20)	30 (20)	30 (20)	50 (30)	50 (30)	50 (30)	50 (30)	50 (30)	50 (30)
	Max. Height Difference			20	25	25	30	30	30	30	30	30
Operating Range	Cooling		°CDB	-15 to 46	-15 to 46	-15 to 46	-15 to 46	-15 to 46	-15 to 46	-15 to 46	-15 to 46	-15 to 46
	Heating			-15 to 24	-15 to 24	-15 to 24	-15 to 24	-15 to 24	-15 to 24	-15 to 24	-15 to 24	-15 to 24
Refrigerant	Type (Global Warming Potential)		kg (CO2eq-T)	R32 (675)	R32 (675)	R32 (675)	R32 (675)	R32 (675)	R32 (675)	R32 (675)	R32 (675)	R32 (675)
	Charge			1.02 (0.689)	1.25 (0.844)	1.25 (0.844)	1.90 (1.283)	1.90 (1.283)	2.70 (1.823)	1.90 (1.283)	2.70 (1.823)	2.70 (1.823)

Optional parts

* For optional parts compatibility of Intesis devices, refer to the optional parts compatibility list Page C-046.

Compact wired remote controller:	UTY-RCRYZ1	External connect kit:	UTY-XWZXZG	Network Converter for single split (DC power supply type):	UTY-VTGX
Wired remote controller (touch panel):	UTY-RNRYZ5	WLAN adapter:	UTY-TFSXZ1	Network Converter for single split (AC power supply type):	UTY-VTGXV
Wired remote controller:	UTY-RLRY	Drain pump unit:	UTR-DPB24T		
Simple remote controller (without operation mode):	UTY-RHRY	IR receiver unit:	UTY-LBTYH		
Simple remote controller:	UTY-RSRY	L-type piping kit:	UTP-FX24A (18/22/24)		
External input and output PCB:	UTY-XCSX	External switch controller:	UTP-FX35A (30/36/45/54)		
External input and output PCB box:	UTZ-GXEA				

Dimensions

(Unit: mm)

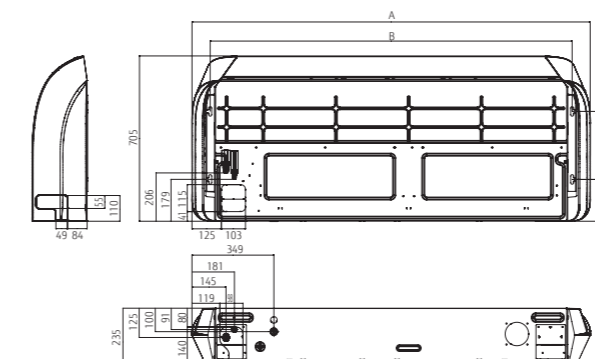

	ABYG18/22KRTA	ABYG24/30KRTA	ABYG36/45/54KRTA
A	1,080	1,390	1,700
B	923	1,233	1,543



ECO Series Lineup Specifications

Compact cassette



Model name	Indoor unit		AUXG09KVLA	AUXG12KVLA	AUXG14KVLA	AUXG18KVLA	AUXG22KVLA	AUXG24KVLA
	Outdoor unit		AOYG09KATA	AOYG12KATA	AOYG14KATA	AOYG18KATA	AOYG22KATA	AOYG24KATA
Power Source			Single phase, ~230 V, 50 Hz					
Capacity	Cooling	kW	2.5 (0.9-2.7)	3.5 (0.9-3.7)	4.3 (0.9-4.5)	5.2 (0.9-5.4)	6.0 (0.9-6.3)	6.8 (0.9-7.4)
	Heating		3.2 (0.9-3.9)	4.1 (0.9-4.4)	5.0 (0.9-5.3)	6.0 (0.9-6.3)	7.0 (0.9-7.4)	7.5 (0.9-8.6)
Input Power	Cooling/Heating	kW	0.68/0.88	1.09/1.17	1.37/1.42	1.69/1.72	1.95/2.00	2.26/2.08
	Cooling		W/W	3.68	3.21	3.14	3.08	3.08
EER	Cooling	W/W	3.64	3.50	3.52	3.49	3.50	3.61
	Heating		2.5/2.3	3.5/2.8	4.3/3.2	5.2/3.8	6.0/4.4	6.8/5.4
Pdesign	Cooling/Heating (-10°C)	kW	6.2	6.1	6.1	6.1	6.1	5.9
	Cooling		W/W	4.0	4.0	4.0	3.9	3.9
SEER	Cooling	W/W	4.0	4.0	4.0	3.9	3.9	3.8
	Heating		A++	A++	A++	A++	A++	A+
Energy Efficiency Class	Cooling	A	A+	A+	A+	A	A	A
	Heating		6.9/6.9	7.7/7.7	9.2/9.2	10.1/10.1	11.6/11.6	12.6/12.6
Max. Operating Current	Cooling/Heating	A	141	201	247	298	344	403
	Cooling		kWh/a	804	979	1,120	1,362	1,578
Annual Energy Consumption	Cooling	kWh/a	0.6	1.2	1.5	2.2	2.6	2.7
	Heating		I/h	33/31/29/27	37/34/30/27	38/34/30/27	38/34/30/26	44/42/36/30
Moisture Removal	Indoor (Cooling)	H/M/L/Q	34/32/29/27	37/34/31/29	43/38/34/30	43/38/34/30	45/43/40/33	49/45/40/33
	Indoor (Heating)		H/M/L/Q	47/48	49/50	50/51	51/52	52/53
Sound Pressure Level	Outdoor (Cooling/Heating)	High	46/47	49/49	50/55	50/55	56/57	59/61
	Indoor (Cooling/Heating)		High	60/60	62/62	63/63	63/64	64/65
Sound Power Level	Outdoor (Cooling/Heating)	High	540/1,610	600/1,630	680/1,670	680/1,710	830/2,240	930/2,885
	Indoor/Outdoor (Cooling)		High	540/1,550	600/1,410	800/1,580	800/1,840	860/2,240
Airflow Rate	Indoor/Outdoor (Heating)	High	245 × 570 × 570	245 × 570 × 570	245 × 570 × 570	245 × 570 × 570	245 × 570 × 570	245 × 570 × 570
	Indoor		mm	541 × 663 × 290	541 × 663 × 290	542 × 799 × 290	542 × 799 × 290	632 × 799 × 290
Net Dimensions H × W × D	Indoor	mm	15 (33)	15 (33)	15 (33)	15 (33)	16 (35)	16 (35)
	Outdoor	mm	23 (51)	25 (55)	32 (71)	33 (73)	36 (79)	38 (84)
Weight	Indoor	kg (lbs)	6.35/9.52	6.35/9.52	6.35/9.52	6.35/12.70	6.35/12.70	6.35/12.70
	Outdoor	kg (lbs)	25/32	25/32	25/32	25/32	25/32	25/32
Connection Pipe Diameter (Liquid/Gas)			15 (15)	15 (15)	20 (15)	20 (15)	25 (15)	25 (20)
Drain port Diameter (I.D./O.D.)			15	15	15	15	20	20
Max. Pipe Length (Pre-Charge)			-10 to 46	-10 to 46	-10 to 46	-10 to 46	-10 to 46	-10 to 46
Max. Height Difference			-15 to 24	-15 to 24	-15 to 24	-15 to 24	-15 to 24	-15 to 24
Operating Range	Cooling	°CDB	R32 (675)	R32 (675)	R32 (675)	R32 (675)	R32 (675)	R32 (675)
	Heating		kg (CO2eq-T)	0.6 (0.405)	0.7 (0.473)	0.85 (0.574)	0.9 (0.608)	1.1 (0.743)
Refrigerant	Type (Global Warming Potential)	kg (CO2eq-T)	UTG-UFYF-W	UTG-UFYF-W	UTG-UFYF-W	UTG-UFYF-W	UTG-UFYF-W	UTG-UFYF-W
	Charge		mm	49 × 620 × 620	49 × 620 × 620	49 × 620 × 620	49 × 620 × 620	49 × 620 × 620
Cassette Grille	Model name	mm	2.3 (5)	2.3 (5)	2.3 (5)	2.3 (5)	2.3 (5)	2.3 (5)
	Dimensions (H × W × D)		kg (lbs)	53 × 950 × 950	53 × 950 × 950	53 × 950 × 950	53 × 950 × 950	53 × 950 × 950
Cassette Grille	Dimensions (H × W × D)	mm	6.0 (13)	6.0 (13)	6.0 (13)	6.0 (13)	6.0 (13)	6.0 (13)
	Weight		kg (lbs)	53 × 950 × 950	53 × 950 × 950	53 × 950 × 950	53 × 950 × 950	53 × 950 × 950

Circular cassette



Model name	Indoor unit		AUXG18KRLB	AUXG22KRLB	AUXG24KRLB	AUXG30KRLB	AUXG36KRLB	AUXG45KRLB	AUXG54KRLB	AUXG36KRLB	AUXG45KRLB	AUXG54KRLB		
	Outdoor unit		AOYG18KATA	AOYG22KATA	AOYG24KATA	AOYG30KATA	AOYG36KATA	AOYG45KATA	AOYG54KATA	AOYG36KATA	AOYG45KATA	AOYG54KATA		
Power Source			Single phase, ~230 V, 50 Hz									3-phase, ~400 V, 50 Hz		
Capacity	Cooling	kW	5.2 (0.9-5.4)	6.0 (0.9-6.3)	6.8 (0.9-7.4)	8.5 (2.8-9.6)	9.5 (2.8-10.6)	12.1 (4.0-12.6)	13.4 (4.5-13.8)	9.5 (2.8-10.6)	12.1 (4.0-12.6)	13.4 (4.5-13.8)		
	Heating		6.0 (0.9-6.3)	7.0 (0.9-7.4)	7.5 (0.9-8.6)	10.0 (2.7-10.8)	10.8 (2.7-12.5)	13.5 (4.2-15.0)	15.5 (4.7-16.0)	10.8 (2.7-12.5)	13.5 (4.2-15.0)	15.5 (4.7-16.0)		
Input Power	Cooling/Heating	kW	1.60/1.66	1.85/1.93	2.12/1.97	2.56/2.64	3.06/2.58	4.32/3.77	4.87/4.86	3.06/2.58	4.32/3.77	4.87/4.86		
	Cooling		W/W	3.25	3.24	3.21	3.32	3.10	2.80	2.75	3.10	2.80	2.75	
EER	Cooling	W/W	3.61	3.63	3.81	3.79	4.19	3.58	3.19	4.19	3.58	3.19		
	Heating		kW	5.2/3.8	6.0/4.4	6.8/5.4	8.5/8.0	9.5/8.7	-	-	9.5/8.7	-	-	
Pdesign	Cooling/Heating (-10°C)	kW	6.2	6.2	6.1	6.1	6.1	-	-	6.1	-	-		
	Cooling		W/W	4.1	4.1	4.0	4.0	4.0	-	-	4.0	-	-	
SEER	Cooling	W/W	A+	A+	A+	A+	A+	-	-	A+	-	-		
	Heating		A+	A+	A+	A+	A+	-	-	A+	-	-		
Energy Efficiency Class	Cooling	A	10.1/10.1	11.6/11.6	12.6/12.6	22.5/22.5	22.5/22.5	28.1/28.1	28.1/28.1	10.5/10.5	13.6/13.6	13.6/13.6		
	Heating		kWh/a	293	338	390	488	545	-	-	545	-	-	
Max. Operating Current	Cooling	kWh/a	1,297	1,502	1,887	2,794	3,044	-	-	3,044	-	-		
	Heating		I/h	1.5	2.2	2.7	2.5	3.3	4.5	5.0	3.3	4.5	5.0	
Moisture Removal	Indoor (Cooling)	H/M/L/Q	33/32/31/28	33/32/31/28	35/33/32/29	40/38/36/33	44/41/38/34	46/42/39/35	47/43/40/36	44/41/38/34	46/42/39/35	47/43/40/36		
	Indoor (Heating)		H/M/L/Q	33/32/31/28	33/32/31/28	35/33/32/29	40/38/36/33	44/41/38/34	46/42/39/35	47/43/40/36	44/41/38/34	46/42/39/35	47/43/40/36	
Sound Pressure Level	Outdoor (Cooling/Heating)	High	51/52	52/53	54/55	53/55	55/55	58/59	58/61	55/55	60/60	61/61		
	Indoor (Cooling/Heating)		High	47/47	49/49	49/49	54/54	58/58	60/60	61/61	58/58	-	-	
Sound Power Level	Outdoor (Cooling/Heating)	High	63/64	64/65	66/67	68/69	70/70	72/73	74/75	70/70	72/73	74/75		
	Indoor (Cooling/Heating)		High	1,050/1,710	1,050/2,240	1,150/2,885	1,600/3,750	1,870/3,750	2,000/4,450	2,100/4,450	1,870/3,750	2,000/4,450	2,100/4,450	
Airflow Rate	Indoor/Outdoor (Cooling)	High	1,050/1,840	1,050/2,240	1,150/2,350	1,600/3,750	1,870/3,750	2,000/4,450	2,100/4,780	1,870/3,750	2,000/4,450	2,100/4,780		
	Indoor/Outdoor (Heating)		High	246 × 840 × 840	246 × 840 × 840	246 × 840 × 840	288 × 840 × 840	288 × 840 × 840	288 × 840 × 840	288 × 840 × 840	288 × 840 × 840	288 × 840 × 840	288 × 840 × 840	
Net Dimensions H × W × D	Indoor	mm	542 × 799 × 290	632 × 799 × 290	632 × 799 × 290	788 × 940 × 320	788 × 940 × 320	998 × 940 × 320	998 × 940 × 320	788 × 940 × 320	998 × 940 × 320	998 × 940 × 320		
	Outdoor		mm	23 (51)	23 (51)	24 (53)	26 (57)	29 (64)	29 (64)	29 (64)	29 (64)	29 (64)		
Weight	Indoor	kg (lbs)	33 (73)	36 (79)	38 (84)	52 (115)	52 (115)	61 (134)	63 (139)	53 (117)	62 (137)	63 (139)		
	Outdoor		kg (lbs)	6.35/12.70	6.35/12.70	6.35/12.70	9.52/15.88	9.52/15.88	9.52/15.88	9.52/15.88	9.52/15.88	9.52/15.88	9.52/15.88	
Connection Pipe Diameter (Liquid/Gas)			25/32	25/32	25/32	25/32	25/32	25/32	25/32	25/32	25/32			
Drain port Diameter (I.D./O.D.)			20 (15)	25 (15)	25 (20)	30 (30)	30 (30)	30 (30)	30 (30)	30 (30)	30 (30)	30 (30)		
Max. Pipe Length (Pre-Charge)			15	20	20	30	30	30	30	30	30	30		
Max. Height Difference			-10 to 46	-10 to 46	-10 to 46	-10 to 46	-10 to 46	-10 to 46	-10 to 46	-10 to 46	-10 to 46	-10 to 46		
Operating Range	Cooling	°CDB	-15 to 24	-15 to 24	-15 to 24	-15 to 24	-15 to 24	-15 to 24	-15 to 24	-15 to 24	-15 to 24	-15 to 24		
	Heating		R32 (675)	R32 (675)	R32 (675)	R32 (675)	R32 (675)	R32 (675)	R32 (675)	R32 (675)	R32 (675)	R32 (675)		
Refrigerant	Type (Global Warming Potential)	kg (CO2eq-T)	0.9 (0.608)	1.1 (0.743)	1.25 (0.844)	1.90 (1.283)	1.90 (1.283)	2.4 (1.620)	2.4 (1.620)	1.90 (1.283)	2.4 (1.620)	2.4 (1.620)		
	Charge		mm	53 × 950 × 950	53 × 950 × 950	53 × 950 × 950	53 × 950 × 950	53 × 950 × 950	53 × 950 × 950	53 × 950 × 950	53 × 950 × 950	53 × 950 × 950	53 × 950 × 950	
Cassette Grille	Model name	mm	53 × 950 × 950	53 × 950 × 950	53 × 950 × 950	53 × 950 × 950	53 × 950 × 950	53 × 950 × 950	53 × 950 × 950	53 × 950 × 950	53 × 950 × 950	53 × 950 × 950		
	Dimensions (H × W × D)		kg (lbs)	6.0 (13)	6.0 (13)	6.0 (13)	6.0 (13)	6.0 (13)	6.0 (13)	6.0 (13)	6.0 (13)	6.0 (13)	6.0 (13)	
Cassette Grille	Dimensions (H × W × D)	mm	53 × 950 × 950	53 × 950 × 950	53 × 950 × 950	53 × 950 × 950	53 × 950 × 950	53 × 950 × 950	53 × 950 × 950	53 × 950 × 950	53 × 950 × 950	53 × 950 × 950		
	Weight		kg (lbs)	6.0 (13)	6.0 (13)	6.0 (13)	6.0 (13)	6.0 (13)	6.0 (13)	6.0 (13)	6.0 (13)	6.0 (13)	6.0 (13)	

Slim Duct



Model name	Indoor unit		ARXG09KLLAP	ARXG12KLLAP	ARXG14KLLAP	ARXG18KLLAP
	Outdoor unit		AOYG09KATA	AOYG12KATA	AOYG14KATA	AOYG18KATA
Power Source	Single phase, ~230 V, 50 Hz					
Capacity	Cooling	kW	2.5 (0.9-2.7)	3.5 (0.9-3.7)	4.3 (0.9-4.5)	5.2 (0.9-5.4)
	Heating		3.2 (0.9-3.9)	4.1 (0.9-4.4)	5.0 (0.9-5.3)	6.0 (0.9-6.3)
Input Power	Cooling/Heating	kW	0.69/0.88	1.09/1.17	1.37/1.42	1.66/1.71
EER	Cooling	W/W	3.62	3.21	3.14	3.13
COP	Heating		3.64	3.50	3.52	3.51
Pdesign	Cooling/Heating (-10°C)	kW	2.5/2.3	3.5/2.8	4.3/3.2	5.2/3.8
SEER	Cooling	W/W	5.9	5.8	5.6	5.8
SCOP	Heating		3.8	3.8	3.8	3.8
Energy Efficiency Class	Cooling		A+	A+	A+	A+
	Heating		A	A	A	A
Max. Operating Current	Cooling/Heating	A	6.9/6.9	7.7/7.7	9.2/9.2	10.1/10.1
Annual Energy Consumption	Cooling	kWh/a	148	211	269	313
	Heating		847	1,031	1,177	1,398
Moisture Removal		l/h	0.7	1.3	1.5	2.0
Sound Pressure Level	Indoor (Cooling)	H/M/L/Q	28/27/26/25	29/28/26/25	32/30/28/26	32/30/29/27
	Indoor (Heating)	H/M/L/Q	28/26/25/24	29/28/26/24	32/30/28/25	32/30/29/27
Sound Power Level	Outdoor (Cooling/Heating)	High	47/48	49/50	50/51	51/52
	Indoor (Cooling/Heating)	High	57/57	58/58	60/60	58/58
Airflow Rate	Indoor/Outdoor (Cooling)	High	600/1,610	650/1,630	800/1,670	940/1,710
	Indoor/Outdoor (Heating)	High	600/1,550	650/1,410	800/1,580	940/1,840
Static pressure range (Standard)		Pa	0 to 90 (25)	0 to 90 (25)	0 to 90 (25)	0 to 90 (25)
Net Dimensions H x W x D	Indoor	mm	198 × 700 × 620	198 × 700 × 620	198 × 700 × 620	198 × 900 × 620
	Outdoor	mm	541 × 663 × 290	541 × 663 × 290	542 × 799 × 290	542 × 799 × 290
Weight	Indoor	kg (lbs)	17 (37)	17 (37)	17 (37)	20 (44)
	Outdoor	kg (lbs)	23 (51)	25 (55)	32 (71)	33 (73)
Connection Pipe Diameter (Liquid/Gas)		mm	6.35/9.52	6.35/9.52	6.35/9.52	6.35/12.70
Drain port Diameter (I.D./O.D.)		mm	25/32	25/32	25/32	25/32
Max. Pipe Length (Pre-Charge)		m	15 (15)	15 (15)	20 (15)	20 (15)
Max. Height Difference			15	15	15	15
Operating Range	Cooling	°CDB	-10 to 46	-10 to 46	-10 to 46	-10 to 46
	Heating		-15 to 24	-15 to 24	-15 to 24	-15 to 24
Refrigerant	Type (Global Warming Potential)		R32 (675)	R32 (675)	R32 (675)	R32 (675)
	Charge	kg (CO2eq-T)	0.6 (0.405)	0.7 (0.473)	0.85 (0.574)	0.9 (0.608)

Medium Static Pressure Duct



Model name	Indoor unit		ARXG22KMLB	ARXG24KMLA	ARXG30KMLA	ARXG36KMLA	ARXG45KMLA	ARXG36KMLA	ARXG45KMLA
	Outdoor unit		AOYG22KATA	AOYG24KATA	AOYG30KATA	AOYG36KATA	AOYG45KATA	AOYG36KQTA	AOYG45KQTA
Power Source	Single phase, ~230 V, 50 Hz						3-phase, ~400 V, 50 Hz		
Capacity	Cooling	kW	6.0 (0.9-6.3)	6.8 (0.9-7.4)	8.5 (2.8-9.6)	9.5 (2.8-10.6)	12.1 (4.0-12.6)	9.5 (2.8-10.6)	12.1 (4.0-12.6)
	Heating		7.0 (0.9-7.4)	7.5 (0.9-8.6)	10.0 (2.7-10.8)	10.8 (2.7-12.5)	13.5 (4.2-15.0)	10.8 (2.7-12.5)	13.5 (4.2-15.0)
Input Power	Cooling/Heating	kW	1.92/2.00	2.19/2.00	2.78/2.77	3.13/3.03	4.84/4.18	3.13/3.03	4.84/4.18
EER	Cooling	W/W	3.13	3.11	3.06	3.04	2.50	3.04	2.50
COP	Heating		3.50	3.75	3.61	3.56	3.23	3.56	3.23
Pdesign	Cooling/Heating (-10°C)	kW	6.0/4.4	6.8/5.4	8.5/8.0	9.5/8.7	-	9.5/8.7	-
SEER	Cooling	W/W	5.8	5.9	5.8	5.6	-	5.6	-
SCOP	Heating		3.8	3.9	3.9	3.9	-	3.9	-
Energy Efficiency Class	Cooling		A+	A+	A+	A+	-	A+	-
	Heating		A	A	A	A	-	A	-
Max. Operating Current	Cooling/Heating	A	11.6/11.6	12.6/12.6	22.5/22.5	22.5/22.5	28.1/28.1	10.5/10.5	13.6/13.6
Annual Energy Consumption	Cooling	kWh/a	362	403	513	594	-	594	-
	Heating		1,620	1,935	2,871	3,122	-	3,122	-
Moisture Removal		l/h	2.1	2.5	2.5	3.0	4.0	3.0	4.0
Sound Pressure Level	Indoor (Cooling)	H/M/L/Q	31/29/27/25	31/29/27/25	39/35/30/26	39/35/30/26	42/38/32/28	39/35/30/26	42/38/32/28
	Indoor (Heating)	H/M/L/Q	31/29/27/25	31/29/27/25	42/35/30/26	42/35/30/26	42/38/32/28	42/35/30/26	42/38/32/28
Sound Power Level	Outdoor (Cooling/Heating)	High	52/53	54/55	53/55	55/55	58/59	55/55	58/59
	Indoor (Cooling/Heating)	High	60/62	60/62	65/69	65/70	68/70	65/70	68/70
Airflow Rate	Indoor/Outdoor (Cooling)	High	1,100/2,240	1,100/2,885	1,900/3,750	1,900/3,750	2,100/4,450	1,900/3,750	2,100/4,450
	Indoor/Outdoor (Heating)	High	1,100/2,240	1,100/2,350	2,100/3,750	2,100/3,750	2,100/4,450	2,100/3,750	2,100/4,450
Static pressure range (Standard)		Pa	30 - 150 (35)	30 - 150 (35)	30 - 150 (47)	30 - 150 (47)	30 - 150 (60)	30 - 150 (47)	30 - 150 (60)
Net Dimensions H x W x D	Indoor	mm	270 × 1,135 × 700	270 × 1,135 × 700	270 × 1,135 × 700	270 × 1,135 × 700	270 × 1,135 × 700	270 × 1,135 × 700	270 × 1,135 × 700
	Outdoor	mm	632 × 799 × 290	632 × 799 × 290	788 × 940 × 320	788 × 940 × 320	998 × 940 × 320	788 × 940 × 320	998 × 940 × 320
Weight	Indoor	kg (lbs)	35 (77)	35 (77)	38 (84)	38 (84)	39 (86)	38 (84)	39 (86)
	Outdoor	kg (lbs)	36 (79)	38 (84)	52 (115)	52 (115)	61 (134)	53 (117)	62 (137)
Connection Pipe Diameter (Liquid/Gas)		mm	6.35/12.70	6.35/12.70	9.52/15.88	9.52/15.88	9.52/15.88	9.52/15.88	9.52/15.88
Drain port Diameter (I.D./O.D.)		mm	25/32	25/32	25/32	25/32	25/32	35.7/38.1	35.7/38.1
Max. Pipe Length (Pre-Charge)		m	25 (15)	25 (20)	30 (30)	30 (30)	30 (30)	30 (30)	30 (30)
Max. Height Difference			20	20	30	30	30	30	30
Operating Range	Cooling	°CDB	-10 to 46	-10 to 46	-10 to 46	-10 to 46	-10 to 46	-10 to 46	-10 to 46
	Heating		-15 to 24	-15 to 24	-15 to 24	-15 to 24	-15 to 24	-15 to 24	-15 to 24
Refrigerant	Type (Global Warming Potential)		R32 (675)	R32 (675)	R32 (675)	R32 (675)	R32 (675)	R32 (675)	R32 (675)
	Charge	kg (CO2eq-T)	1.1 (0.743)	1.25 (0.844)	1.90 (1.283)	1.90 (1.283)	2.4 (1.620)	1.9 (1.283)	2.4 (1.620)

Ceiling



Model name	Indoor unit		ABYG18KRTA	ABYG22KRTA	ABYG24KRTA	ABYG30KRTA	ABYG36KRTA	ABYG45KRTA	ABYG36KRTA	ABYG45KRTA
	Outdoor unit		AOYG18KATA	AOYG22KATA	AOYG24KATA	AOYG30KATA	AOYG36KATA	AOYG45KATA	AOYG36KQTA	AOYG45KQTA
Power Source	Single phase, ~230 V, 50 Hz						3-phase, ~400 V, 50 Hz			
Capacity	Cooling	kW	5.2 (0.9-5.4)	6.0 (0.9-6.3)	6.8 (0.9-7.4)	8.5 (2.8-9.6)	9.5 (2.8-10.6)	12.1 (4.0-12.6)	9.5 (2.8-10.6)	12.1 (4.0-12.6)
	Heating		6.0 (0.9-6.3)	7.0 (0.9-7.4)	7.5 (0.9-8.6)	10.0 (2.7-10.8)	10.8 (2.7-12.5)	13.5 (4.2-15.0)	10.8 (2.7-12.5)	13.5 (4.2-15.0)
Input Power	Cooling/Heating	kW	1.66/1.71	1.95/2.09	2.19/2.00	2.78/2.86	3.13/3.03	4.84/4.18	3.13/3.03	4.84/4.18
EER	Cooling	W/W	3.13	3.08	3.11	3.06	3.04	2.50	3.04	2.50
COP	Heating		3.51	3.35	3.75	3.5	3.56	3.23	3.56	3.23
Pdesign	Cooling/Heating (-10°C)	kW	5.2/3.8	6.0/4.4	6.8/5.4	8.5/8.0	9.5/8.7	-	9.5/8.7	-
SEER	Cooling	W/W	5.8	5.6	6.0	5.8	5.6	-	5.6	-
SCOP	Heating		3.8	3.8	3.9	3.9	3.9	-	3.9	-
Energy Efficiency Class	Cooling		A+	A+	A+	A+	A+	-	A+	-
	Heating		A	A	A	A	A	-	A	-
Max. Operating Current	Cooling/Heating	A	10.1/10.1	11.6/11.6	12.6/12.6	22.5/22.5	22.5/22.5	28.1/28.1	10.5/10.5	13.6/13.6
Annual Energy Consumption	Cooling	kWh/a	538	375	679	512	594	-	594	-
	Heating		1,398	1,618	1,935	2,871	3,117	-	3,117	-
Moisture Removal		l/h	2.0	2.5	2.2	3.0	2.6	4.5	2.6	4.5
Sound Pressure Level	Indoor (Cooling)	H/M/L/Q	38/36/33/31	42/37/34/31	41/36/32/29	45/40/35/32	44/40/37/32	45/41/39/34	44/40/37/32	45/41/39/34
	Indoor (Heating)	H/M/L/Q	38/36/33/31	42/37/34/31	41/36/32/29	45/40/35/32	44/40/37/32	45/41/39/34	44/40/37/32	45/41/39/34
Sound Power Level	Outdoor (Cooling/Heating)	High	51/52	52/53	54/55	53/55	55/55	58/59	55/55	58/59
	Indoor (Cooling/Heating)	High	53/53	57/57	56/56	60/60	59/59	60/60	59/59	60/60
Airflow Rate	Indoor/Outdoor (Cooling)	High	840/1,710	900/2,240	1,230/2,885	1,400/3,750	1,850/3,750	1,900/4,450	1,850/3,750	1,900/4,450
	Indoor/Outdoor (Heating)	High	840/1,840	900/2,240	1,230/2,350	1,400/3,750	1,800/3,750	1,850/4,450	1,800/3,750	1,850/4,450
Net Dimensions H x W x D	Indoor	mm	235 × 1,080 × 705	235 × 1,080 × 705	235 × 1,390 × 705	235 × 1,390 × 705	235 × 1,700 × 705	235 × 1,700 × 705	235 × 1,700 × 705	235 × 1,700 × 705
	Outdoor	mm	542 × 799 × 290	632 × 799 × 290	632 × 799 × 290	788 × 940 × 320	788 × 940 × 320	988 × 940 × 320	788 × 940 × 320	988 × 940 × 320
Weight	Indoor	kg (lbs)	24 (53)	24 (53)	31 (68)	31 (68)	38 (84)	38 (84)	38 (84)	38 (84)
	Outdoor	kg (lbs)	33 (73)	36 (79)	38 (84)	52 (115)	52 (115)	61 (134)	53 (117)	62 (137)
Connection Pipe Diameter (Liquid/Gas)		mm	6.35/12.7	6.35/12.7	6.35/12.7	9.52/15.88	9.52/15.88	9.52/15.88	9.52/15.88	9.52/15.88
Drain port Diameter (I.D./O.D.)		mm	25/32	25/32	25/32	25/32	25/32	25/32	25/32	25/32
Max. Pipe Length (Pre-Charge)		m	20 (15)	25 (15)	25 (20)	30 (30)	30 (30)	30 (30)	30 (30)	30 (30)
Max. Height Difference			15	20	20	30	30	30	30	30
Operating Range	Cooling	°CDB	-10 to 46	-10 to 46	-10 to 46	-10 to 46	-10 to 46	-10 to 46	-10 to 46	-10 to 46
	Heating		-15 to 24	-15 to 24	-15 to 24	-15 to 24	-15 to 24	-15 to 24	-15 to 24	-15 to 24
Refrigerant	Type (Global Warming Potential)		R32 (675)	R32 (675)	R32 (675)	R32 (675)	R32 (675)	R32 (675)	R32 (675)	R32 (675)
	Charge	kg (CO2eq-T)	0.9 (0.608)	1.1 (0.743)	1.25 (0.844)	1.90 (1.283)	1.90 (1.283)	2.40 (1.620)	1.90 (1.283)	2.40 (1.620)

Feature Summary

Type	Wall-mounted type				Wall-mounted type			
Series	Flagship Series	Designer Series		Standard Series	ECO Series			
Model name	ASYG12KXCA	ASYG07/09/12/14KGTB	ASYG07/09/12/14KETA, ASYG07/09/12/14KETA-B	ASYG07/09/12/14KMCC	ASYG18/24KMTB	ASYG30/36KMTA	ASYG07/09/12KPCA, ASYG18/24KLCA	
Energy-Saving Features	Dual-fan	●						
	Save Human sensor	●	●			●		
	Save & Stop Human sensor							
	Economy mode	●	●	●	●	●	●	
	Setting temperature range limitation		○		○	○	○	
	Set temperature auto return		○		○	○		
Features for Comfort	Powerful heating							
	Power diffuser	●						
	Server room operation							
	Powerful mode	●	●	●	●	●	●	
	10°C Heat	●	●	●	●	●		
	Low noise mode	●	●	●	●	●		
	Auto changeover	●	●	●	●	●	●	
	UP/DOWN swing louver		●	●	●		●	
	Double swing automatic	●				●		
	Automatic fan speed	●	●	●	●	●	●	
	Auto restart	●	●	●	●	●	●	
	Connectable fresh air duct							
	Fresh air intake							
	Connectable distributing duct							
Individual airflow direction control								
Convenience Features	Auto-off timer		○		○	○		
	Sleep timer	●	●	●	●	●	●	
	Program timer	●	●	●	●	●	●	
	Weekly timer		●	●	○	●		
	Weekly & Temperature setback timer		○		○	○		
	Filter sign		●	●	●	●	●	
	External error output		○		○	○		
	External ON/OFF input		○		○	○		
Clean Features	Wireless LAN control	●	○		○	○	○	
	Plasma air clean	●						
	Filter auto clean	●						
	Ion deodorization filter		●	●	○	●		
	Apple-catechin filter		●	●	○	●		
	Long-life filter							
Installation	Washable panel		●	●	●		●	
	Silver Ion Filter		○	○	○	○	○	
	Automatic airflow adjustment							
	Drain pump as standard							
	Blue fin				●			

○: Optional function

Feature Summary

Type	Cassette		Duct		Duct			Floor	Ceiling	
Series	Compact 4-way Flow Series	Circular Flow Series	Slim (With drain pump)	Medium Static Pressure (Compact & Comfort)	Medium Static Pressure (Standard)	High Static Pressure		Big		
Model name	AUXG 09/12/14/18/22/24 KVLA	AUXG 18/22/24/30/36/45/54 KRLB	ARXG09/12/14/18KLLAP	ARXG 12/14/18/22/24/30/36/45/54 KHTAP	ARXG22KMLB ARXG24/30/36/45KMLA	ARXG45/54KHTA	ARYG60LHTA	ARYG72/90LHTA	AGYG09/12/14KVCA	ABYG 18/22/24/30/36/45/54 KRTA
Energy-Saving Features	Dual-fan									
	Save human sensor									
	Save & Stop human sensor		○							
	Economy mode	●	●	●	●	●	●	●	●	●
	Setting temperature range limitation	○	●	○	●	○	○	○	●	○
	Set temperature auto return	●	●	●	●	●	●	○	●	●
	Powerful heating									
Features for Comfort	Power diffuser									
	Server room operation									
	Powerful mode								●	
	10°C Heat	●	○	○	○	○	○ (60)	○	●	○
	Low noise mode		○ (45/54)		○ (45/54)	○ (45) (36LMLA)	○	○	●	○
	Auto changeover	●	●	●	●	●	●	●	●	●
	UP/DOWN swing louver	●	●	○					●	●
	Double swing automatic									
	Automatic fan speed	●	●	●	●	●	●	●	●	●
	Auto restart	●	●	●	●	●	●	●	●	●
	Connectable fresh air duct		●		●	●				●
	Fresh air intake	○	○	○	○	○	○	○		○
	Connectable distributing duct		●		●	●				
	Individual airflow direction control		●							
	Convenience Features	Auto-off timer	●	●	●	●	●	○ (60)	●	○
Sleep timer		●	○	○	○	○	○ (60)	○	●	○
Program timer		●	○	○	○	○	○ (60)	○	●	○
Weekly timer		●	●	●	●	●		●	●	●
Weekly & Temperature setback timer		○		●	●	●	●			
Filter sign		●	●	●	●	●	●	●	●	●
External error output			○		○			○	○	○
External ON/OFF input		●	●	●	●	●	○	●	○	●
Wireless LAN control		○	○	○	○	○	○	○	○	○
Clean Features	Plasma air clean									
	Filter auto clean									
	Ion deodorization filter								●	
	Apple-catechin filter								●	
	Long-life filter				○	○	○ (60)	○	●	
	Washable panel									
Installation	Silver Ion Filter	○	○	○	○	○	○	○	○	
	Automatic airflow adjustment				●			●		
	Drain pump as standard	●	●	●	●	○		○		○
Blue fin		● (30/36/45/54)		● (30/36/45/54)	● (45)	●	●	●		● (30/36/45/54)

○ Optional function



Light Commercial & Residential MULTI-SPLIT

- M-002 Multi-split Overview
- M-004 Multi-split Outdoor Units Lineup
- M-006 2-unit to 8-unit Multi-split Connectable Indoor Units
- M-010 Simultaneous Multi-split Connectable Indoor Units
- M-048 Feature Summary



Refrigerant type R32 models

- M-012 2-unit to 5-unit Multi-split
- M-018 Simultaneous Multi-split Twin/Triple
-
- M-022 2-unit to 5-unit Multi-split Indoor Units Specifications
-
- M-026 2-unit to 5-unit Multi-split Combination Table



Refrigerant type R410A models

- 6-unit to 8-unit Multi-split**
- M-014 6-unit Multi-split
- M-016 8-unit Multi-split
- Simultaneous Multi-split Type**
- M-020 Simultaneous Multi-split Twin/Triple/Double Twin
-
- M-024 6-unit to 8-unit Multi-split Indoor Units Specifications
-
- M-036 6-unit to 8-unit Multi-split Combination Table

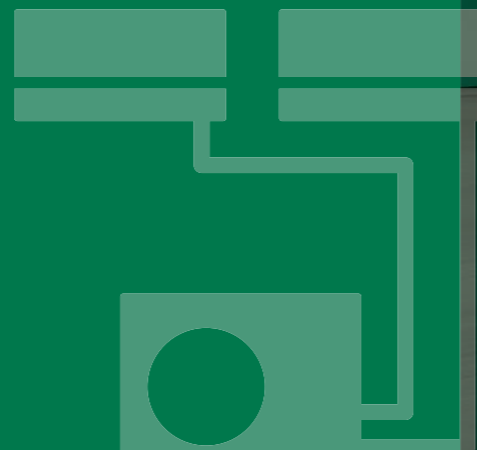

A single outdoor unit drives multiple indoor units, offering greater flexibility in system configuration.

If you wish to keep an entire floor or two or more rooms comfortable, we recommend you choose a multi-split air conditioning system with a single outdoor unit. Choose one that meets your air conditioning requirements from the variety of models we offer. You can mix and match indoor and outdoor units as you wish to build the system that best suits your needs.

Multi-split Overview

Multi-split's space-saving outdoor unit allows for connections of up to eight indoor units for multiple rooms. Added to the lineup are models compatible with the new R32 refrigerant, offering environmentally friendly comfort in homes, offices, stores, and various other settings.



NEW 3-unit, 4-unit, 5-unit Multi-split Types



3-unit 18/24 class



4-unit 30 class
5-unit 36 class

2-unit Multi-split



14 class



18 class

2-unit to 8-unit Multi-split

Recommended for residences, offices, and other situations where multiple rooms require air conditioning. Each of the 2 to 8 connected indoor units can also be operated individually. Operation control, time scheduling for each room, and energy-saving options can be set on both individual and central remote controllers. The outdoor unit is designed to save space and is flexible enough to be installed on a balcony or underneath a waist-high window.

6-unit, 8-unit Multi-split



6-unit 45 class



8-unit 45 class

Twin/Triple



Twin 36 class
(Single-phase/3-phase)



Twin/Triple 45/54 class
(Single-phase/3-phase)



Twin/Triple/Double Twin



72/90 class
(3-phase)

Simultaneous Multi-split Type

Suitable for a small building, the entrance hall of a small office, meeting rooms, educational facilities, and other roomy areas where multiple indoor units need to be operated simultaneously. Up to 4 indoor units can be operated simultaneously, making the system perfect for air conditioning not only offices with large spaces, but also spaces with atypical layouts.

Multi-split Outdoor Units Lineup



FUJITSU GENERAL (Euro) GmbH participates in the ECP program for VRF. Check ongoing validity of certificate: www.eurovent-certification.com
*Models so marked are not ECC certified.

		Class	14	18	18	24	30	36	45		54	72	90
		Cooling rated capacity (kW)	4.0	5.0	5.4	6.8	8.0	10.0	12.5	14.0	14.0	19.0	22.0
2-unit, 3-unit, 4-unit, 5-unit Multi-split	2-unit Multi-split Up to 2 units		AOYG14KBTA2	AOYG18KBTA2									
	3-unit Multi-split Up to 3 units	NEW			AOYG18KBTA3	AOYG24KBTA3							
	4-unit Multi-split Up to 4 units	NEW					AOYG30KBTA4						
	5-unit Multi-split Up to 5 units	NEW						AOYG36KBTA5*1					
6-unit Multi-split	6-unit Multi-split Up to 6 units	R410A							AOYG45LBLA6*				
8-unit Multi-split Up to 8 units		R410A								AOYG45LBT8*			
Simultaneous Multi-split	Twin Single-phase							AOYG36KBTB	AOYG45KBTB				
	Twin 3-phase							AOYG36KRTA	AOYG45KRTA				
	Twin/Triple Single-phase	R32									AOYG54KBTB		
	Twin/Triple 3-phase										AOYG54KRTA		
	Twin/Triple/Double Twin 3-phase	R410A										AOYG72LRLA	AOYG90LRLA

Notes: **1. 2-unit Multi-split:** Connectable indoor units are 2 units.
AOYG14KBTA2: Total capacity of indoor units connected must be between 4.0 kW and 6.0 kW.
AOYG18KBTA2: Total capacity of indoor units connected must be between 4.0 kW and 7.5 kW.
2. 3-unit Multi-split: Connectable indoor units are 2 to 3 units.
AOYG18KBTA3: Total capacity of indoor units connected must be between 4.0 kW and 8.5 kW.
AOYG24KBTA3: Total capacity of indoor units connected must be between 4.0 kW and 10.5 kW.

3. 4-unit Multi-split: Connectable indoor units are 2 to 4 units.
AOYG30KBTA4: Total capacity of indoor units connected must be between 7.5 kW and 14.0 kW.
4. 5-unit Multi-split: Connectable indoor units are 2 to 5 units.
AOYG36KBTA5: Total capacity of indoor units connected must be between 7.5 kW and 15.5 kW.

5. 6-unit Multi-split: Connectable indoor units are 2 to 6 units.
AOYG45LBLA6: Total capacity of indoor units connected must be between 9.5 kW and 18.0 kW.
6. 8-unit Multi-split: Connectable indoor units are 2 to 8 units.
AOYG45LBT8: Total capacity of indoor units connected must be between 11.0 kW and 18.0 kW.

Cooling rated capacity: *1: 9.5 kW

2-unit to 8-unit Multi-split Connectable Indoor Units



Type	2-unit		3-unit		4-unit	5-unit	
Model name	AOYG14KBT2	AOYG18KBT2	AOYG18KBT3	AOYG24KBT3	AOYG30KBT4	AOYG36KBT5	
Multi-split Type Outdoor Unit							
Capacity (kW)	Cooling	4.0	5.0	5.4	6.8	8.0	9.5
	Heating	4.4	5.6	6.8	8.0	9.6	10.6

Indoor Unit	BTU	kW Class	2-unit	3-unit	4-unit	5-unit
 ASYG07/09/12/14KETA	7,000	2.0	●	●	●	●
	9,000	2.5	●	●	●	●
 ASYG07/09/12/14KETA-B	12,000	3.5	●	●	●	●
	14,000	4.0	—	●	●	●
 NEW	18,000	5.0	—	—	—	●
	22,000	6.0	—	—	—	●
	24,000	7.0	—	—	—	●
 NEW	9,000	2.5	●	●	●	●
	12,000	3.5	●	●	●	●
	14,000	4.0	—	●	●	●
	7,000	2.0	●	●	●	●
	9,000	2.5	●	●	●	●
	12,000	3.5	●	●	●	●
	14,000	4.0	—	●	●	●
	18,000	5.0	—	—	—	●
	7,000	2.0	●	●	●	●
	9,000	2.5	●	●	●	●
	12,000	3.5	●	●	●	●
	14,000	4.0	—	●	●	●
	7,000	2.0	●	●	●	●
	9,000	2.5	●	●	●	●
	12,000	3.5	●	●	●	●
	14,000	4.0	—	●	●	●
 NEW	22,000	6.0	—	—	—	●
	18,000	5.0	—	—	—	●
 NEW	18,000	5.0	—	—	—	●
	22,000	6.0	—	—	—	●



Type	6-unit	8-unit	
Model name	AOYG45LBA6	AOYG45LBT8	
Multi-split Type Outdoor Unit			
Capacity (kW)	Cooling	12.5	14.0
	Heating	13.5	16.0

Indoor Unit	BTU	kW Class	6-unit	8-unit
	7,000	2.0	●	●
	9,000	2.5	●	●
	12,000	3.5	●	●
	14,000	4.0	●	●
	18,000	5.0	●	●
	24,000	7.0	●	●
	9,000	2.5	●	●
	12,000	3.5	●	●
	14,000	4.0	●	●
	7,000	2.0	●	●
	9,000	2.5	●	●
	12,000	3.5	●	●
	14,000	4.0	●	●
 ABYG18LVTB	14,000	4.0	●	●
	18,000	5.0	●	●
	7,000	2.0	●	—
	9,000	2.5	●	—
	12,000	3.5	●	—
	14,000	4.0	●	—
	7,000	2.0	●	●
	9,000	2.5	●	●
	12,000	3.5	●	●
	14,000	4.0	●	●
	18,000	5.0	●	●

Simultaneous Multi-split Connectable Indoor Units



Type	4HP		5HP		6HP	
Model name	AOYG36KBTB	AOYG36KRTA	AOYG45KBTB	AOYG45KRTA	AOYG54KBTB	AOYG54KRTA
Simultaneous Multi-split Type Outdoor Unit						
Capacity (kW)	Cooling	9.5	12.1	13.4	13.4	13.4
	Heating	10.8	13.5	15.5	15.5	15.5

Indoor Unit	BTU	kW Class	Twin			Triple
			● × 2	● × 2	● × 2	● × 3
 AUXG18/22/24KVLA	18,000	5.0	● × 2	-	-	● × 3
	22,000	6.5	-	● × 2	-	-
	24,000	7.0	-	-	● × 2	-
 ARXG18KLLAP	18,000	5.0	● × 2	-	-	● × 3
	22,000	6.5	-	● × 2	-	-
	24,000	7.0	-	-	● × 2	-
 ARXG22KMLB ARXG24KMLA	22,000	6.5	-	● × 2	-	-
	24,000	7.0	-	-	● × 2	-
	Separation tube			UTP-SX236A (18/22/24)		UTP-SX354A (18)



Type	8HP	10HP	
Model name	AOYG72LRLA	AOYG90LRLA	
Simultaneous Multi-split Outdoor Unit			
Capacity (kW)	Cooling	19.0	22.0
	Heating	22.4	27.0

Indoor Unit	BTU	kW Class	Twin	Triple	Double Twin	Twin	Triple	Double Twin
			● × 2	● × 3	● × 4	● × 2	● × 3	● × 4
 AUYG18/22/24LV	18,000	5.0	-	-	● × 4	-	-	-
	22,000	6.5	-	-	-	-	-	● × 4
	24,000	7.0	-	● × 3	-	-	-	-
 AUYG30/36/45LR	30,000	8.8	-	-	-	-	● × 3	-
	36,000	10.6	● × 2	-	-	-	-	-
	45,000	12.5	-	-	-	● × 2	-	-
 ARYG18LLTB	18,000	5.0	-	-	● × 4	-	-	-
	22,000	6.5	-	-	-	-	-	● × 4
	24,000	7.0	-	● × 3	-	-	-	-
 ARYG22/24/ 30/36/45LM	30,000	8.8	-	-	-	-	● × 3	-
	36,000	10.6	● × 2	-	-	-	-	-
	45,000	12.5	-	-	-	● × 2	-	-
	18,000	5.0	-	-	● × 4	-	-	-
 ABYG18/22/24LV	22,000	6.5	-	-	-	-	-	● × 4
	24,000	7.0	-	● × 3	-	-	-	-
	30,000	8.8	-	-	-	-	● × 3	-
 ABYG30/36/45LR	36,000	10.6	● × 2	-	-	-	-	-
	45,000	12.5	-	-	-	● × 2	-	-
	Separation tube			UTP-SX272A × 1	UTP-SX372A × 1	UTP-SX272A × 1, UTP-SX236A × 2	UTP-SX272A × 1	UTP-SX372A × 1

2-unit,
3-unit,
4-unit,
5-unit,
Multi-split



High energy saving

With the adoption of a high-efficiency DC twin-rotary compressor, all models achieved an energy efficiency scale of A+++ for cooling and A++ for heating.

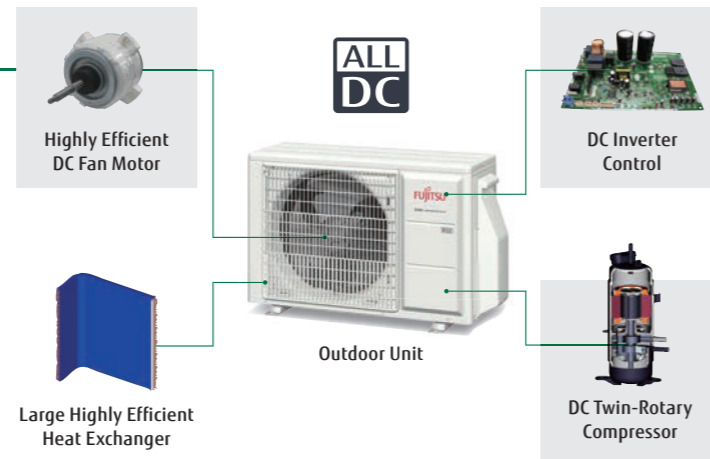
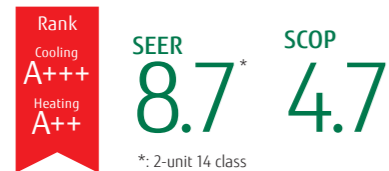

R32 refrigerant model

In addition to its high energy efficiency, the R32 refrigerant has a larger volumetric capacity than the R410A refrigerant, which means the R32 refrigerant models require less refrigerant charge than the R410A models.

	Pre-charge refrigerant amount (kg)	
	REFRIGERANT R32	REFRIGERANT R410A
2-unit 14 class	0.9	1.25
2-unit 18 class	1.02	1.30
3-unit 18 class	1.8	2.2
3-unit 24 class	1.8	2.2
4-unit 30 class	2.2	3.3
5-unit 36 class	2.5	4.0

Quiet operation

The sound power level is reduced by up to 7 dB compared to the current R410 models.

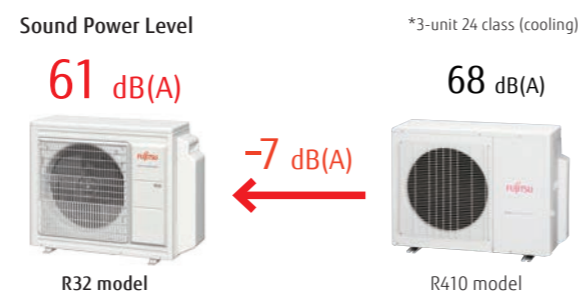

Space-saving installation

Multiple indoor units can be connected to 1 outdoor unit by long piping as well. Unlike a single type, the outdoor unit can be installed in the most space-saving location.



Compact design

Unlike a single type, the outdoor unit can be installed in the most space-saving location.

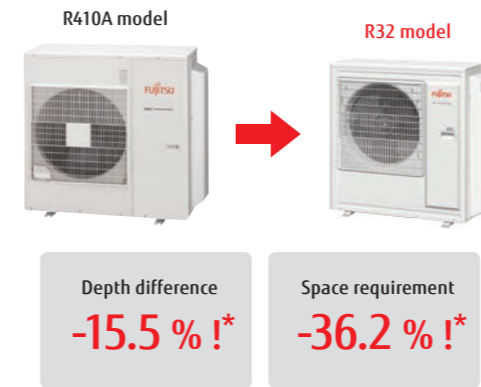

*: Compared with current 5-unit multi models

Easy evacuation

All connected pipes and indoor units can be evacuated quickly via our centralized valve method. Requires evacuation only once.

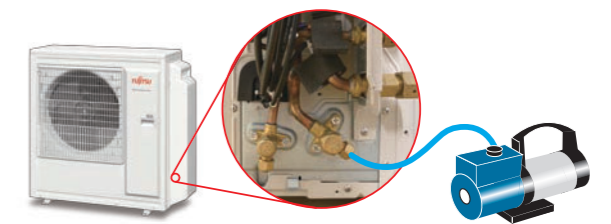

Wide range of indoor units with various models

We offer 41 models in 5 types in a capacity range from 2.0 kW to 6.0 kW. Wide range of requirements can be realized from private homes through to large shops and hotels



Models equipped with the New R32 Refrigerant

Wall-mounted type with sophisticated design



Middle and small capacity models are available. This makes installation easier in small spaces.



2-unit: AOYG14KBTA2/AOYG18KBTA2
 3-unit: **NEW** AOYG18KBTA3/ **NEW** AOYG24KBTA3
 4-unit: **NEW** AOYG30KBTA4
 5-unit: **NEW** AOYG36KBTA5



Specifications (2-unit)

Model name			AOYG14KBTA2	AOYG18KBTA2
Power Source			Single phase, ~230 V, 50 Hz	
Rated Capacity (Min. - Max.)	Cooling	kW	4.0 (1.4-4.6)	5.0 (1.7-5.8)
	Heating		4.4 (1.1-5.5)	5.6 (1.8-6.6)
EER	Cooling	W/W	4.12	4.03
	Heating		4.63	4.59
Sound Pressure Level (High)	Cooling	dB(A)	47	47
	Heating		49	50
Sound Power Level (High)	Cooling	dB(A)	60	60
	Heating		62	62
Airflow Rate	Cooling/Heating	m ³ /h	1,670/1,670	1,960/2,020
Net Dimensions H × W × D			542 × 799 × 290	632 × 799 × 290
Weight			33 (73)	37 (82)
Connection Pipe Diameter	Liquid	mm	6.35 × 2	6.35 × 2
	Gas		9.52 × 2	9.52 × 2
Max. Pipe Length			30/20	30/20
Max. Height Difference	Between Outdoor Unit and Each Indoor Unit	m	15	15
	Between Indoor Units		10	10
Operating Range	Cooling	°CDB	-10 to 46	-10 to 46
	Heating		-15 to 24	-15 to 24
Refrigerant	Type (Global Warming Potential)	kg (CO ₂ eq-T)	R32 (675)	R32 (675)
	Charge		0.9 (0.608)	1.02 (0.689)

Specifications (3-unit)

Model name			AOYG18KBTA3	AOYG24KBTA3
Power Source			Single phase, ~230 V, 50 Hz	
Rated Capacity (Min. - Max.)	Cooling	kW	5.4 (1.8-7.0)	6.8 (1.8-8.5)
	Heating		6.8 (2.0-8.0)	8.0 (2.0-9.2)
EER	Cooling	W/W	4.78	3.90
	Heating		4.89	4.40
Sound Pressure Level (High)	Cooling	dB(A)	46	48
	Heating		49	53
Sound Power Level (High)	Cooling	dB(A)	59	61
	Heating		61	67
Airflow Rate	Cooling/Heating	m ³ /h	2,220/2,160	2,270/2,730
Net Dimensions H × W × D			716 × 820 × 315	716 × 820 × 315
Weight			46 (102)	46 (102)
Connection Pipe Diameter	Liquid	mm	6.35 × 3	6.35 × 3
	Gas		9.52 × 3	9.52 × 2, 12.70 × 1 adapter [12.70 → 9.52] × 1
Max. Pipe Length			50/25	50/25
Max. Height Difference	Between Outdoor Unit and Each Indoor Unit	m	15	15
	Between Indoor Units		10	10
Operating Range	Cooling	°CDB	-10 to 46	-10 to 46
	Heating		-15 to 24	-15 to 24
Refrigerant	Type (Global Warming Potential)	kg (CO ₂ eq-T)	R32 (675)	R32 (675)
	Charge		1.8 (1.215)	1.8 (1.215)

Specifications (4-unit, 5-unit)

Model name			AOYG30KBTA4	AOYG36KBTA5
Power Source			Single phase, ~230 V, 50 Hz	
Rated Capacity (Min. - Max.)	Cooling	kW	8.0 (2.4-10.1)	9.5 (3.0-11.0)
	Heating		9.6 (3.0-11.2)	10.6 (3.5-12.0)
EER	Cooling	W/W	3.90	3.80
	Heating		4.55	4.50
Sound Pressure Level (High)	Cooling	dB(A)	50	52
	Heating		54	55
Sound Power Level (High)	Cooling	dB(A)	63	65
	Heating		66	68
Airflow Rate	Cooling/Heating	m ³ /h	2,400/2,950	2,450/2,900
Net Dimensions H × W × D			884 × 820 × 315	884 × 820 × 315
Weight			55 (121)	59 (130)
Connection Pipe Diameter	Liquid	mm	6.35 × 4	6.35 × 5
	Gas		9.52 × 2, 12.70 × 2 adapter [12.70 → 9.52] × 2	9.52 × 3, 12.70 × 2 adapter [12.70 → 9.52] × 2 adapter [9.52 → 12.70] × 1
Max. Pipe Length*			70/25	75/25
Max. Height Difference	Between Outdoor Unit and Each Indoor Unit	m	15	15
	Between Indoor Units		10	10
Operating Range	Cooling	°CDB	-10 to 46	-10 to 46
	Heating		-15 to 24	-15 to 24
Refrigerant	Type (Global Warming Potential)	kg (CO ₂ eq-T)	R32 (675)	R32 (675)
	Charge		2.2 (1.485)	2.5 (1.688)

*Length not applicable when floor units are connected. For details, refer to the installation manual.

Dimensions

(Unit: mm)

2-unit: AOYG14KBTA2

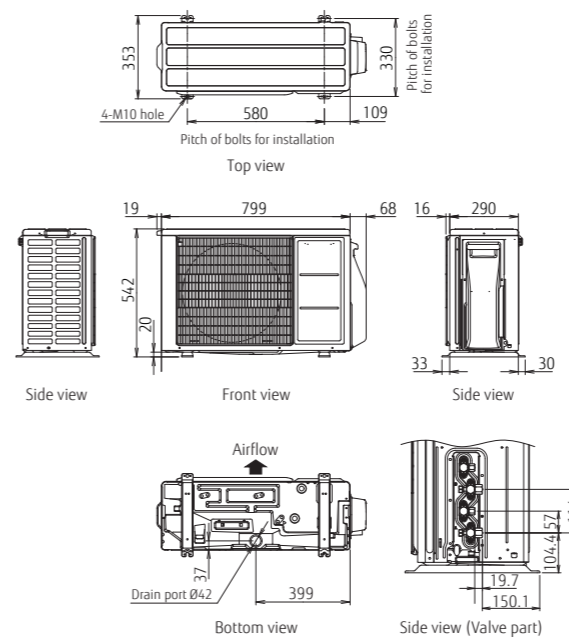

2-unit: AOYG18KBTA2

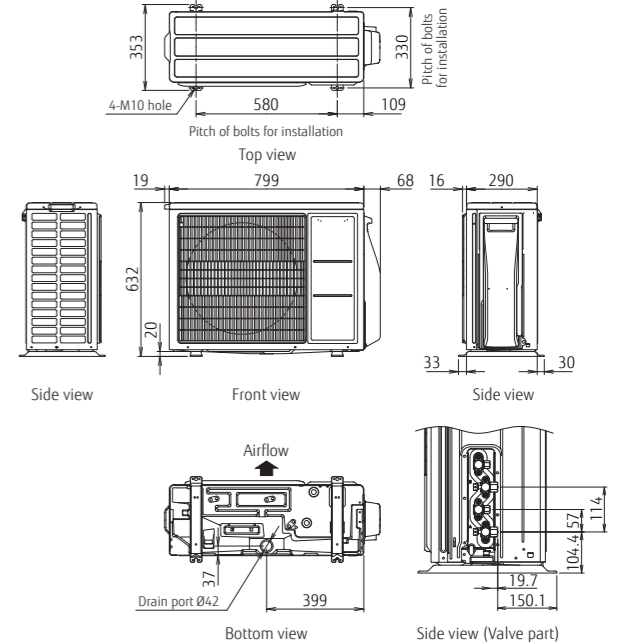

3-unit: AOYG18KBTA3/AOYG24KBTA3

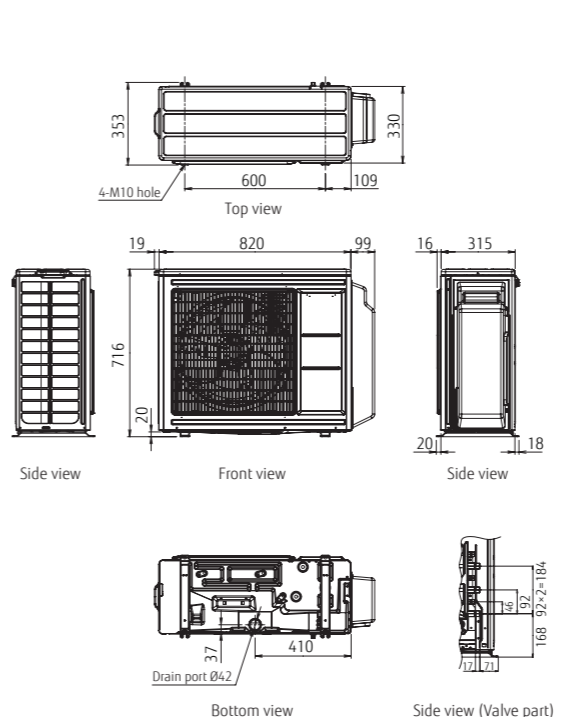

4-unit: AOYG30KBTA4
5-unit: AOYG36KBTA5

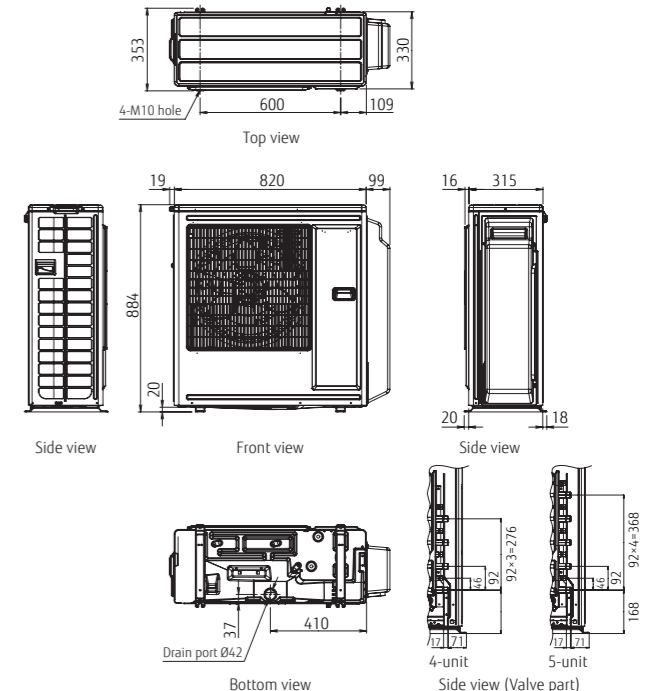

6-unit Multi-split



6-unit: AOYG45LBLA6



Specifications (5-unit, 6-unit)

Model name		AOYG45LBLA6	
Power Source		Single phase, ~230 V, 50 Hz	
Rated Capacity (Min. - Max.)	Cooling	kW	12.5 (3.5-14.0)
	Heating		13.5 (3.5-16.0)
EER	Cooling	W/W	3.50
	Heating		4.00
Sound Pressure Level (High)	Cooling	dB(A)	53
	Heating		55
Sound Power Level (High)	Cooling	-	-
	Heating		-
Airflow Rate	Cooling/Heating	m ³ /h	4,200/4,200
Net Dimensions H × W × D		mm	998 × 970 × 370
Weight		kg (lbs)	94 (207)
Connection Pipe Diameter	Liquid	mm	6.35 × 6
	Gas		9.52 × 4, 12.70 × 2
Max. Pipe Length	Total/Each	m	80/25
	Between Outdoor Unit and Each Indoor Unit.		15
Max. Height Difference	Between Indoor Units.	m	10
	Operating Range		-10 to 46
Operating Range	Cooling	°CDB	-15 to 24
	Heating		-15 to 24
Refrigerant	Type (Global Warming Potential)	R410A (2,088)	
	Charge	kg (CO ₂ eq-T)	4.00 (8.352)

A wide variety of models to choose from

We offer 16 models in 4 types in a capacity range from 2.0 kW to 4.0 kW. Wide range of requirements can be realized from private homes through to large shops and hotels.

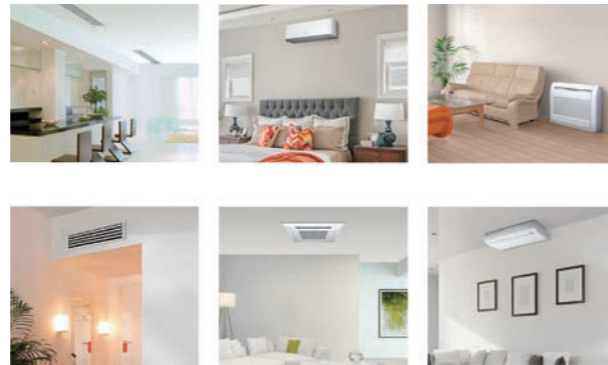

Compact design

Multiple indoor units can be connected to 1 outdoor unit by long piping as well. Unlike a single type, the outdoor unit can be installed in the most space-saving location.



Easy installation

All connected pipes and indoor units can be evacuated quickly via our centralized valve method. Requires evacuation only once.

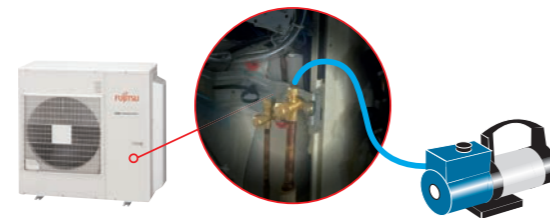

Central & Individual Control

- Batched control of up to 8 indoor units. Unified setting of room temperature, airflow volume, and local control restrictions across units.
- Language can be selected from English, French, German, Greek, Italian, Portuguese, Russian, Spanish, or Turkish.
- Large backlit LED screen
- Large easy-to-see operation panel

Max. Controllable
1 multi-system
Max. Controllable
8 indoor units



Dimensions

(Unit: mm)

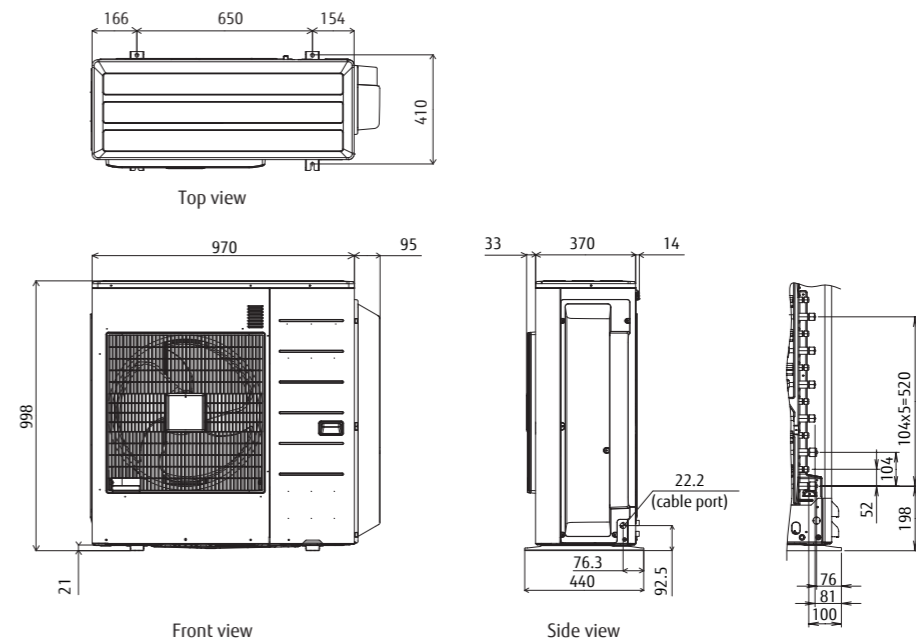

8-unit Multi-split

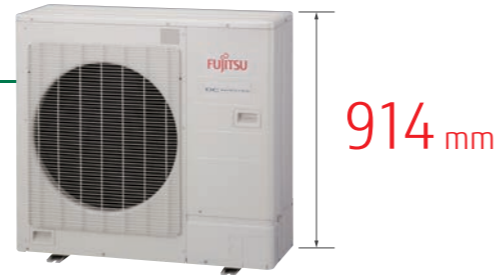

Compact outdoor unit

The compact design outdoor unit can be installed below a window or in a narrow space.

High seasonal energy efficiency

An air conditioner operates under a wide range of outdoor temperatures depending on the season and climate conditions. Moreover, a multi-split system does not have to cool or warm every room in a house or building all the time. This means that an air conditioner operates at partial capacity, instead of rated capacity, for more than 90% of its operation time. Therefore, we pay attention to the energy-saving performance of our air conditioners based on real-world usage. The use of our all DC design and proprietary inverter system significantly improves the energy efficiency of our air conditioners operating in partial-load efficiency.

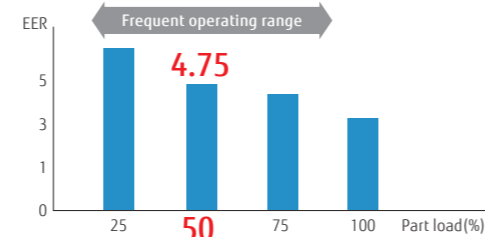

Innovated technology

High-efficiency large fan:
Incorporates high-efficiency fan.

DC fan motor:
The use of a small DC motor achieves both high performance and high efficiency.

Heat exchanger:
The use of high-density piping and the 3-row design achieves a compact and energy-efficient heat exchanger.

High-efficiency DC twin-rotary compressor:
A high-performance, low noise, large-capacity DC twin-rotary compressor is used.

Optimized refrigerant control for faster air conditioning

Optimized refrigerant control allows for faster cooling of every room in a house or building to the desired temperature.

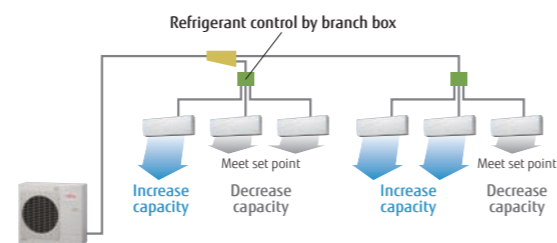

8-unit: AOYG45LBT8

Branch Box: UTP-PY03A/UTP-PY02A

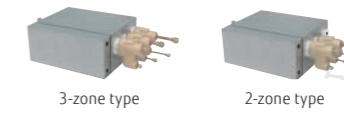

Specifications (Outdoor unit/Branch box)

Outdoor Unit Model Name		AOYG45LBT8	
Maximum Connectable Indoor Unit		8	
Connectable capacity range of indoor units		Cooling	11.2 - 18.2 kW
Power source		Single phase, ~230 V, 50 Hz	
Rated Capacity	Cooling	kW	14.0
	Heating	kW	16.0
Input Power	Cooling	kW	5.20
	Heating	kW	5.07
Airflow rate	Cooling	m ³ /h	4,650
	Heating	m ³ /h	4,800
Sound Pressure Level	Cooling	dB(A)	56
	Heating	dB(A)	58
Heat Exchanger Fin		Plate fin coil	
Net Dimensions H × W × D		mm	914 × 970 × 370
Weight		kg (lbs)	98 (216)
Connection Pipe Diameter (Liquid/Gas)		mm	9.52/15.88
Max. Pipe Length		m	115 (Total)
Max. Height Difference (O.U ~ I.U)		m	30
Operating Range	Cooling	°CDB	-5 to 46
	Heating	°CDB	-15 to 24
Refrigerant	Type (Global Warming Potential)	R410A (2,088)	
	Charge	kg (CO2eq-T)	3.45 (7.204)

Branch Box Model Name		UTP-PY03A	UTP-PY02A
Connectable Indoor Unit		1 to 3 Units	1 to 2 Units
Power source		Single phase, ~230 V, 50 Hz	Single phase, ~230 V, 50 Hz
Available Voltage Range		198-264 V	198-264 V
Power Consumption		W	10
Running Current		A	0.05
Net Dimensions H × W × D		mm	195 × 433 × 370
Weight		kg (lbs)	9 (20)
Connection pipe diameter	Liquid	Main: 9.52 × 1, Branch: 6.35 × 3	
	Gas	Main: 15.88 × 1, Branch: 12.70 × 3	
Method		Flare	Flare

Notes: Specifications are determined based on the following conditions:

- Two indoor units (7-kW class each) are connected.
- Measured in the manufacturer's anechoic chamber.
- Cooling: Indoor temp. of 27°CDB/19°CWB, outdoor temp. of 35°CDB/24°CWB Heating: Indoor temp. of 20°CDB/15°CWB, outdoor temp. of 7°CDB/6°CWB
- Pipe length: 5 m (Outdoor unit - Branch box), 3 m (Branch box - Indoor unit) Height difference: 0 m

Dimensions

(Unit: mm)

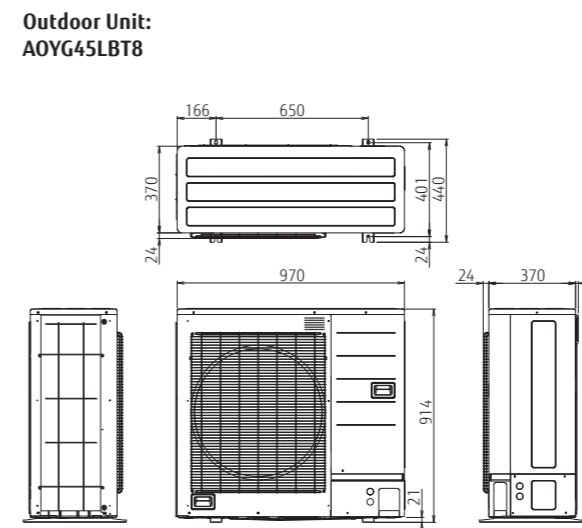

Branch Box: UTP-PY03A (3-zone type)

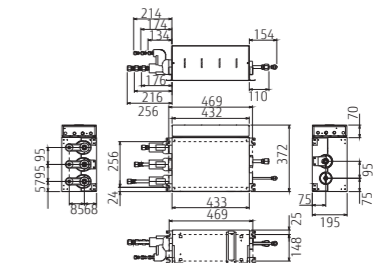

Branch Box: UTP-PY02A (2-zone type)

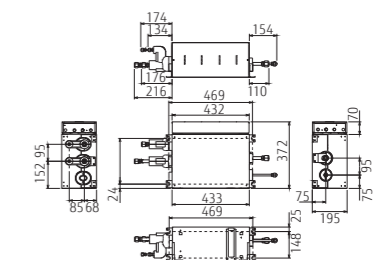

Simultaneous Multi-split Type Twin/Triple



Meets a variety of installation needs from offices to commercial spaces, with up to 3 indoor units in the same room connected to an outdoor unit.

Select indoor units according to floor layout and heat load estimated by the number of people working in the room and the direction and intensity of sunlight entering the room. Perfect airflow distribution can be achieved for optimum comfort.

Installation according to floor layout

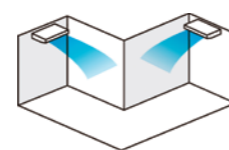

Installation according to lighting conditions

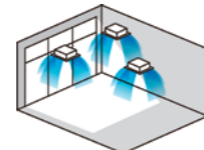

Design flexibility

Slim & Compact Design

The outdoor unit in this series is 22.7% shorter* than a twin-fan outdoor unit. The reduced height makes it easy to install in tight spaces.

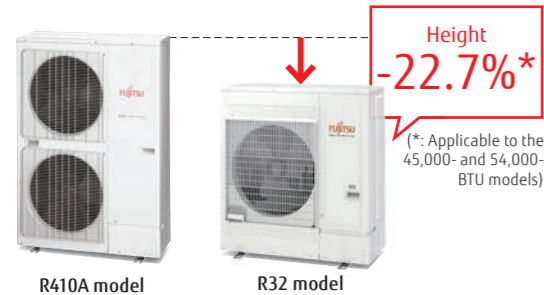

Flexible installation

Pipe length of up to 50 m and a height difference of up to 30 m can be accommodated. Multi-split systems can be installed in large residences and multi-storey buildings.

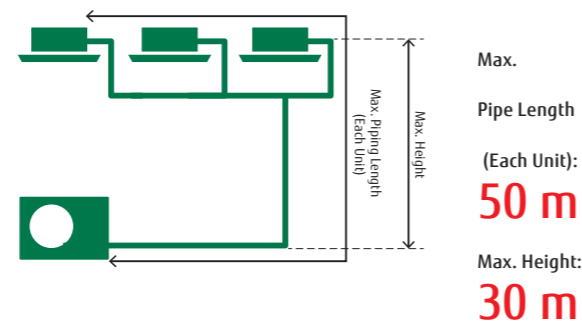

New lineup of indoor units

The indoor units, available in 6 models of 3 types, can be selected according to room size and conditions.



Model: AOYG36KBTB/AOYG45KBTB/AOYG54KBTB
AOYG36KRTA [3-phase]/AOYG45KRTA [3-phase]/AOYG54KRTA [3-phase]



Specifications (Indoor units/Outdoor units)

Indoor Units Model name				Compact Cassette		
				AUXG18KVLA	AUXG22KVLA	AUXG24KVLA
Power Source				Single phase, ~230 V, 50 Hz		
Airflow Rate	Cooling	H/M/L/Q	m ³ /h	680/580/490/410	830/740/600/450	930/830/600/450
	Heating	H/M/L/Q	m ³ /h	800/680/580/450	860/760/700/530	930/850/700/530
Net Dimensions H × W × D				mm		
Weight				kg (lbs)		
Cassette Grille				UTG-UFYF-W		

Indoor Units Model name				Duct		
				ARXG18KLLAP	ARXG22KMLB	ARXG24KMLA
Power Source				Single phase, ~230 V, 50 Hz		
Airflow Rate	Cooling	H/M/L/Q	m ³ /h	940/880/820/750	1,100/910/750/580	1,100/910/750/580
	Heating	H/M/L/Q	m ³ /h	940/880/820/750	1,100/910/750/580	1,100/910/750/580
Net Dimensions H × W × D				mm		
Weight				kg (lbs)		

Outdoor Units Model name			AOYG36KBTB	AOYG45KBTB	AOYG54KBTB	AOYG36KRTA	AOYG45KRTA	AOYG54KRTA	
			Capacity	Cooling	kW	9.5	12.1	13.4	9.5
			Heating	10.8	13.5	15.5	10.8	13.5	15.5
Power Source			Single phase, ~230 V, 50 Hz			3-phase, ~400 V, 50 Hz			
Pdesign	Cooling	kW	9.5	-	-	9.5	-	-	
	Heating (-10°C)	kW	8.7	-	-	8.7	-	-	
SEER	Cooling	W/W	6.10	-	-	6.10	-	-	
	Heating	W/W	4.00	-	-	4.00	-	-	
SCOP	Cooling	kWh/a	545	-	-	545	-	-	
	Heating	kWh/a	3,044	-	-	3,044	-	-	
Energy Efficiency Class	Cooling		A++	-	-	A++	-	-	
	Heating		A+	-	-	A+	-	-	
Sound Pressure Level (High)	Cooling	dB(A)	55	57	57	55	57	57	
	Heating		55	57	59	55	57	59	
	Heating		70	71	73	70	71	73	
Sound Power Level (High)	Cooling	dB(A)	70	71	73	70	71	73	
	Heating		70	71	73	70	71	73	
	Heating		70	71	73	70	71	73	
Airflow Rate	Cooling/Heating	m ³ /h	3,750/3,750	4,450/4,450	4,450/4,450	3,750/3,750	4,450/4,450	4,450/4,450	
Net Dimensions H × W × D			mm	788 × 940 × 320	998 × 940 × 320	998 × 940 × 320	788 × 940 × 320	998 × 940 × 320	998 × 940 × 320
Weight			kg (lbs)	52 (115)	67 (148)	67 (148)	53 (117)	67 (148)	67 (148)
Connection Pipe Diameter (Liquid/Gas)			mm	9.52/15.88	9.52/15.88	9.52/15.88	9.52/15.88	9.52/15.88	9.52/15.88
Max. Pipe Length (Pre-Charge)			m	50 (30)	50 (30)	50 (30)	50 (30)	50 (30)	50 (30)
Max. Height Difference			m	30	30	30	30	30	30
Operating Range	Cooling	°CDB	-15 to 46	-15 to 46	-15 to 46	-15 to 46	-15 to 46	-15 to 46	
	Heating		-15 to 24	-15 to 24	-15 to 24	-15 to 24	-15 to 24	-15 to 24	
Refrigerant	Type (Global Warming Potential)		R32 (675)	R32 (675)	R32 (675)	R32 (675)	R32 (675)	R32 (675)	
	Charge	kg (CO ₂ eq-T)	1.90 (1.283)	2.70 (1.823)	2.70 (1.823)	1.90 (1.283)	2.70 (1.823)	2.70 (1.823)	
Separation tube				UTP-SX236A (Twin)	UTP-SX236A (Twin)	UTP-SX236A (Twin) UTP-SX354A (Triple)	UTP-SX236A (Twin)	UTP-SX236A (Twin) UTP-SX354A (Triple)	

* Indoor units of different types and capacity cannot be connected.
* The above specifications apply when used with a cassette type indoor unit.

Dimensions

(Unit: mm)

AOYG36KBTB/AOYG36KRTA

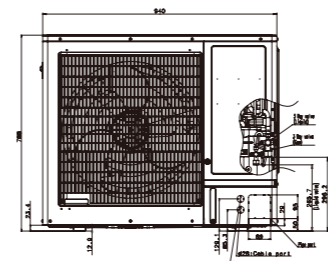
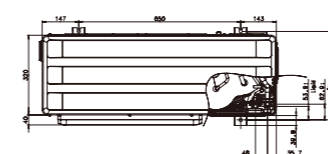

AOYG45KBTB/AOYG54KBTB AOYG45KRTA/AOYG54KRTA

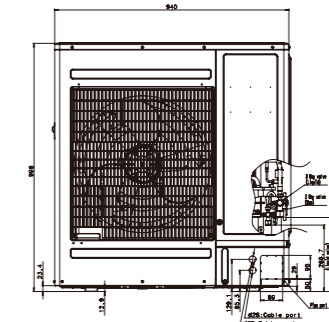
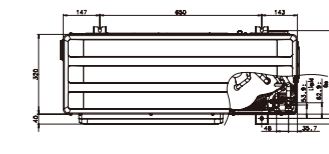

Simultaneous Multi-split Type Twin/Triple/Double Twin



Meets a variety of installation needs from an open-plan office to a retail store, with up to 4 indoor units connected to an outdoor unit.

Select indoor units according to floor layout and heat load estimated by the number of people working in the room and the direction and intensity of sunlight entering the room. Perfect airflow distribution can be achieved for optimum comfort.

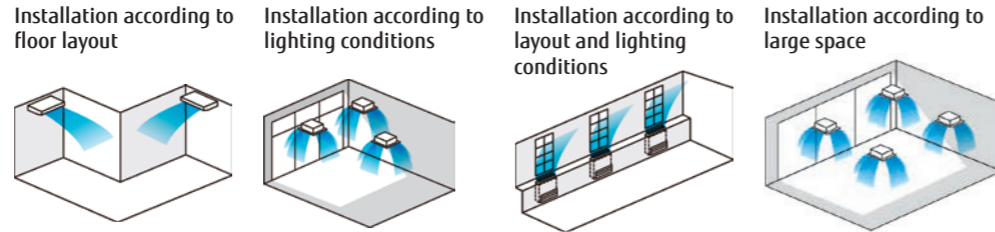

Simultaneous control

Up to 16 indoor units can be controlled simultaneously with a wired remote controller.

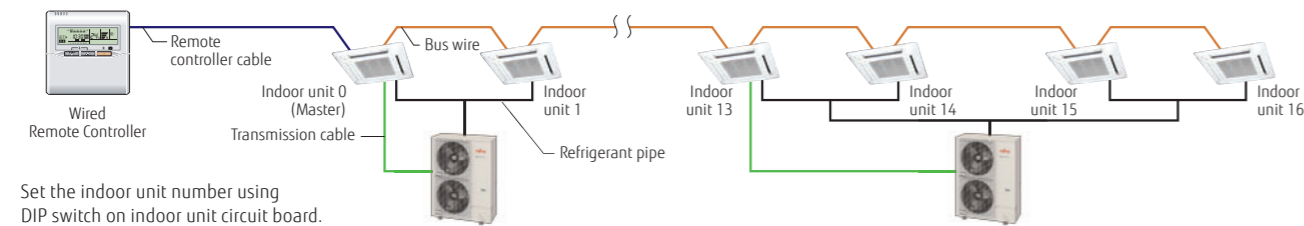

Set the indoor unit number using DIP switch on indoor unit circuit board.

*The following functions are not provided by a wireless remote controller: Timer operation, Sleep Timer operation, 10°C Heat operation

Indoor unit lineup

The indoor units, available in 18 models of 6 types, can be selected according to room size and conditions.

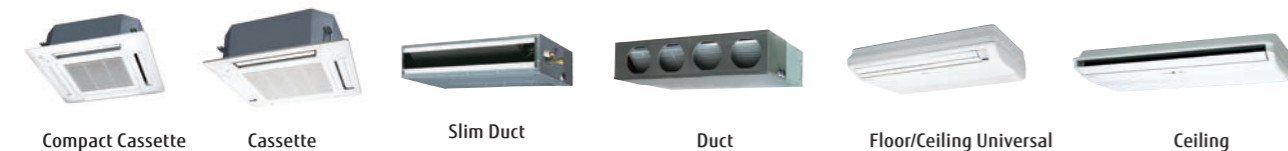

Model: AOYG72LRLA [3-phase]/AOYG90LRLA [3-phase]



Specifications (Indoor units/Outdoor units)

Indoor Units Model name		Compact Cassette, Cassette							
		AUYG18LVLB	AUYG22LVLA	AUYG24LVLA	AUYG30LRLE	AUYG36LRLE	AUYG45LRLA		
Power Source		Single phase, ~230 V, 50 Hz							
Airflow Rate	Cooling	H/M/L/Q	m ³ /h	750/610/520/410	930/830/600/450	930/830/600/450	1,600/1,400/1,270/1,150	1,800/1,400/1,270/1,150	1,900/1,640/1,460/1,250
	Heating	H/M/L/Q	m ³ /h	800/710/600/450	930/860/700/530	930/830/600/450	1,800/1,400/1,270/1,150	1,800/1,400/1,270/1,150	1,900/1,640/1,460/1,250
Net Dimensions H × W × D		mm		245 × 570 × 570	245 × 570 × 570	245 × 570 × 570	288 × 840 × 840	288 × 840 × 840	288 × 840 × 840
Weight		kg (lbs)		15 (33)	16 (35)	16 (35)	26 (57)	26 (57)	26 (57)
Cassette Grille		UTG-UFYD-W						UTG-UGYA-W	

Indoor Units Model name		Duct							
		ARYG18LLTB	ARYG22LMLA	ARYG24LMLA	ARYG30LMLE	ARYG36LMLE	ARYG45LMLA		
Power Source		Single phase, ~230 V, 50 Hz							
Airflow Rate	Cooling	H/M/L/Q	m ³ /h	940/880/820/750	1,100/910/750/580	1,100/910/750/580	1,900/1,620/1,270/980	1,900/1,620/1,270/980	2,100/1,750/1,350/1,070
	Heating	H/M/L/Q	m ³ /h	940/880/820/750	1,100/910/750/580	1,100/910/750/580	2,100/1,620/1,270/980	2,100/1,620/1,270/980	2,100/1,750/1,350/1,070
Net Dimensions H × W × D		mm		198 × 900 × 620	270 × 1135 × 700	270 × 1135 × 700	270 × 1135 × 700	270 × 1135 × 700	270 × 1135 × 700
Weight		kg (lbs)		23 (51)	38 (84)	38 (84)	40 (88)	40 (88)	40 (88)

Indoor Units Model name		Floor/Ceiling, Ceiling							
		ABYG18LVTB	ABYG22LVTA	ABYG24LVTA	ABYG30LRTE	ABYG36LRTE	ABYG45LRTA		
Power Source		Single phase, ~230 V, 50 Hz							
Airflow Rate	Cooling	H/M/L/Q	m ³ /h	780/700/560/500	980/820/680/540	980/820/680/540	1,660/1,500/1,200/1,000	1,900/1,500/1,200/1,000	2,100/1,700/1,400/1,100
	Heating	H/M/L/Q	m ³ /h	780/700/560/500	980/820/680/540	980/820/680/540	1,660/1,500/1,200/1,000	1,900/1,500/1,200/1,000	2,100/1,700/1,400/1,100
Net Dimensions H × W × D		mm		199 × 990 × 655	199 × 990 × 655	199 × 990 × 655	240 × 1660 × 700	240 × 1660 × 700	240 × 1660 × 700
Weight		kg (lbs)		27 (60)	27 (60)	27 (60)	46 (101)	46 (101)	46 (101)

Outdoor Units Model name		AOYG72LRLA		AOYG90LRLA	
		Capacity	Cooling/Heating kW	Capacity	Cooling/Heating kW
Capacity		19.0	22.4	22.0	27.0
Power Source		3-phase, ~400 V, 50 Hz			
Sound Pressure Level (High)		55/55		55/57	
Airflow Rate		8,400/8,400		8,400/9,000	
Net Dimensions H × W × D		1,428 × 1,080 × 480		1,428 × 1,080 × 480	
Weight		163 (359)		172 (379)	
Connection Pipe Diameter (Liquid/Gas)		12.7/25.4		12.7/25.4	
Max. Pipe Length (Pre-Charge)		100 (30)		100 (30)	
Max. Height Difference		30		30	
Operating Range		-15 to 46		-15 to 46	
Refrigerant		R410A (2,088)		R410A (2,088)	
Separation tube		UTP-SX272A × 1 (Twin)	UTP-SX372A × 1 (Triple)	UTP-SX272A × 1 (Twin)	UTP-SX372A × 1 (Triple)
		UTP-SX272A × 1 UTP-SX254A × 2 (Double Twin)		UTP-SX272A × 1 UTP-SX254A × 2 (Double Twin)	

*: That specification is not fixed yet.

• Indoor units of different types and capacity cannot be connected.
• The above specifications apply when used with a cassette type indoor unit.

Dimensions

(Unit: mm)

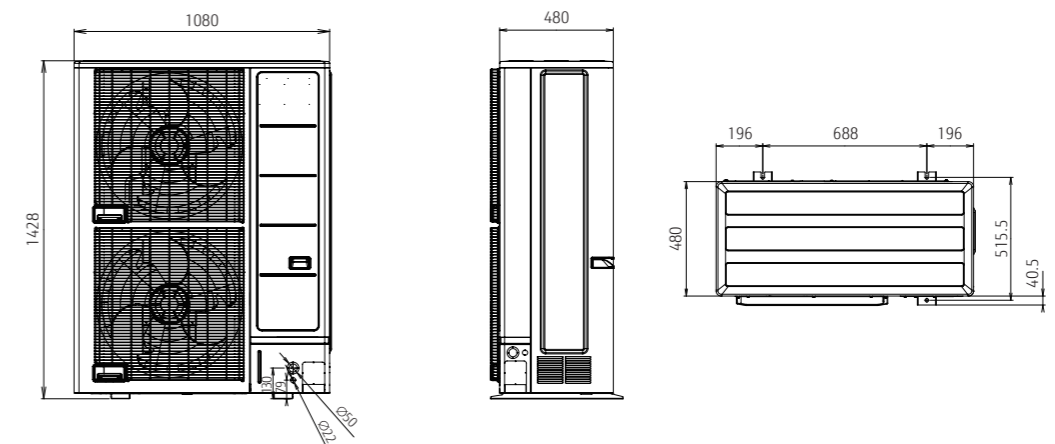

New 2-unit to 5-unit Multi-split Indoor Units Specifications

Wall-mounted type



Model name	Indoor unit		ASYG07KGTB	ASYG09KGTB	ASYG12KGTB	ASYG14KGTB
kW Class			2.0	2.5	3.5	4.0
Power Source			Single phase, ~230 V, 50 Hz			
Sound Pressure Level	Cooling	H/M/L/Q	38/33/29/21	40/34/29/21	40/35/30/21	43/36/30/21
	Heating		41/35/31/22	42/36/31/22	42/38/33/22	44/39/33/24
Sound Power Level	Cooling	H	54	55	56	57
	Heating		56	57	58	59
Airflow Rate	Cooling	H/M/L/Q	650/540/430/270	700/560/430/270	700/560/430/270	770/600/450/280
	Heating		720/580/460/330	750/610/470/330	770/640/520/330	800/660/520/340
Net Dimensions			mm 270 × 834 × 215			
Weight			kg (lbs) 10 (22)			
Connection Pipe Diameter	Liquid/Gas	mm	6.35/9.52			

Wall-mounted type



Model name	Indoor unit		ASYG07KETA ASYG07KETA-B	ASYG09KETA ASYG09KETA-B	ASYG12KETA ASYG12KETA-B	ASYG14KETA ASYG14KETA-B
kW Class			2.0	2.5	3.5	4.0
Power Source			Single phase, ~230 V, 50 Hz			
Sound Pressure Level	Cooling	H/M/L/Q	38/33/29/21	40/34/29/21	40/35/30/21	43/36/30/21
	Heating		41/35/31/22	42/36/31/22	42/38/33/22	44/39/33/24
Sound Power Level	Cooling	H	54	55	55	57
	Heating		56	57	58	59
Airflow Rate	Cooling	H/M/L/Q	650/540/430/270	700/560/430/270	700/560/430/270	770/600/450/280
	Heating		720/580/460/330	750/610/470/330	770/640/520/330	800/660/520/340
Net Dimensions			mm 295 × 950 (wall side: 840) × 230			
Weight			kg (lbs) 11(24)			
Connection Pipe Diameter	Liquid/Gas	mm	6.35/9.52			

Wall-mounted type



Model name	Indoor unit		ASYG07KMCC	ASYG09KMCC	ASYG12KMCC	ASYG14KMCC
kW Class			2.0	2.5	3.5	4.0
Power Source			Single phase, ~230 V, 50 Hz			
Sound Pressure Level	Cooling	H/M/L/Q	38/33/29/21	40/34/29/21	40/35/30/21	43/36/30/21
	Heating		41/35/31/22	42/36/31/22	42/38/33/22	44/39/33/24
Sound Power Level	Cooling	H	54	55	55	57
	Heating		56	57	58	59
Airflow Rate	Cooling	H/M/L/Q	650/540/430/320	700/560/430/320	700/560/430/320	770/600/450/310
	Heating		720/580/460/330	750/610/470/330	780/640/520/330	820/660/520/340
Net Dimensions			mm 270 × 834 × 222			
Weight			kg (lbs) 10 (22)			
Connection Pipe Diameter	Liquid/Gas	mm	6.35/9.52			

Wall-mounted type



Model name	Indoor unit		ASYG18KMTB	ASYG22KMTB	ASYG24KMTB
kW Class			5.0	6.0	7.0
Power Source			Single phase, ~230 V, 50 Hz		
Sound Pressure Level	Cooling	H/M/L/Q	45/40/35/29	48/40/35/29	49/40/35/29
	Heating		46/40/35/29	48/40/35/29	49/40/35/29
Sound Power Level	Cooling	H	60	62	65
	Heating		61	62	65
Airflow Rate	Cooling	H/M/L/Q	980/810/640/510	1,060/810/640/510	1,170/850/640/510
	Heating		1,020/850/640/510	1,060/850/640/510	1,170/850/640/510
Net Dimensions			mm 280 × 980 × 240		
Weight			kg (lbs) 12.5 (27)		
Connection Pipe Diameter	Liquid/Gas	mm	6.35/12.70		

Floor



Model name	Indoor unit		AGYG09KVCA	AGYG12KVCA	AGYG14KVCA
kW Class			2.5	3.5	4.0
Power Source			Single phase, ~230 V, 50 Hz		
Sound Pressure Level	Cooling	H/M/L/Q	39/34/28/22	42/36/30/22	44/38/31/22
	Heating		39/35/30/22	42/38/32/22	44/39/33/22
Sound Power Level	Cooling	H	52	55	56
	Heating		52	55	56
Airflow Rate	Cooling	H/M/L/Q	530/440/360/270	600/490/380/270	650/520/400/270
	Heating		530/460/380/270	600/510/410/270	650/540/430/270
Net Dimensions			mm 600 × 740 × 200		
Weight			kg (lbs) 14 (31)		
Connection Pipe Diameter	Liquid/Gas	mm	6.35/9.52		

Ceiling



Model name	Indoor unit		ABYG18KRTA	ABYG22KRTA
kW Class			5.0	6.0
Power Source			Single phase, ~230 V, 50 Hz	
Sound Pressure Level	Cooling	H/M/L/Q	38/36/33/31	42/37/34/31
	Heating		38/36/33/31	42/37/34/31
Sound Power Level	Cooling	H	53	57
	Heating		53	57
Airflow Rate	Cooling	H/M/L/Q	840/790/710/650	900/790/710/650
	Heating		840/790/710/650	900/790/710/650
Net Dimensions			mm 235 × 1,080 × 705	
Weight			kg (lbs) 24(52)	
Connection Pipe Diameter	Liquid/Gas	mm	6.35/12.70	

Compact Cassette Grid Type



Model name	Indoor unit		AUXG07KVLA	AUXG09KVLA	AUXG12KVLA	AUXG14KVLA	AUXG18KVLA	AUXG22KVLA
kW Class			2.0	2.5	3.5	4.0	5.0	6.0
Power Source			Single phase, ~230 V, 50 Hz					
Sound Pressure Level	Cooling	H/M/L/Q	33/31/29/27	33/31/29/27	37/34/31/28	38/35/32/29	38/35/32/29	44/42/36/30
	Heating		34/32/29/27	34/32/29/27	37/34/31/29	43/38/34/30	43/38/34/30	45/43/40/33
Sound Power Level	Cooling	H	46	46	49	50	50	56
	Heating		47	47	49	55	55	57
Airflow Rate	Cooling	H/M/L/Q	540/490/440/390	540/490/440/390	610/530/470/410	680/580/490/410	680/580/490/410	830/740/600/450
	Heating		540/490/440/390	540/490/440/390	610/530/470/410	790/680/580/450	790/680/580/450	860/760/700/530
Net Dimensions			mm 245 × 570 × 570					
Weight			kg (lbs) 15 (33)					
Panel			UTG-UFYF-W					
Connection Pipe Diameter	Liquid/Gas	mm	6.35/9.52					

Mini duct

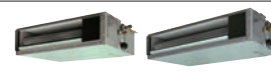

Model name	Indoor unit		ARXG07KSLAP	ARXG09KSLAP	ARXG12KSLAP	ARXG14KSLAP	ARXG18KSLAP
kW Class			2.0	2.5	3.5	4.0	5.0
Power Source			Single phase, ~230 V, 50 Hz				
Sound Pressure Level	Cooling	H/M/L/Q	29/26/24/23	29/26/24/23	31/27/25/23	35/30/27/23	33/29/26/23
	Heating		29/26/24/23	29/26/24/23	31/27/25/23	35/30/27/23	33/29/26/23
Sound Power Level	Cooling	H	52	54	55	60	58
	Heating		53	56	57	62	59
Airflow Rate	Cooling	H/M/L/Q	550/440/390/360	600/450/400/360	650/490/430/360	800/640/530/360	940/750/540/480
	Heating		550/440/390/360	600/450/400/360	650/490/430/360	800/640/530/360	940/750/540/480
Net Dimensions			mm 198 × 700 × 450				
Weight			kg (lbs) 15.5 (34)				
Connection Pipe Diameter	Liquid/Gas	mm	6.35/9.52				
External static pressure			Pa 0 to 30				
Drain pump			Standard				

Slim duct



Model name	Indoor unit		ARXG07KLLAP	ARXG09KLLAP	ARXG12KLLAP	ARXG14KLLAP	ARXG18KLLAP
kW Class			2.0	2.5	3.5	4.0	5.0
Power Source			Single phase, ~230 V, 50 Hz				
Sound Pressure Level	Cooling	H/M/L/Q	28/26/25/24	28/27/26/25	29/28/27/26	32/30/28/26	32/30/29/27
	Heating		28/26/25/24	28/26/25/24	29/28/27/24	32/30/28/25	32/30/29/27
Sound Power Level	Cooling	H	57	57	58	60	58
	Heating		57	57	58	60	58
Airflow Rate	Cooling	H/M/L/Q	550/490/470/440	600/550/500/450	650/600/550/480	800/700/600/480	940/880/820/750
	Heating		550/490/470/440	600/550/500/450	650/600/550/480	800/700/600/480	940/880/820/750
Net Dimensions			mm 198 × 700 × 620				
Weight			kg (lbs) 17 (37)				
Connection Pipe Diameter	Liquid/Gas	mm	6.35/9.52				
External static pressure			Pa 0 to 90				
Drain pump			Standard				

Medium Static Pressure Duct



Model name	Indoor unit		ARXG22KMLB
kW Class			6.0
Power Source			Single phase, ~230 V, 50 Hz
Sound Pressure Level	Cooling	H/M/L/Q	31/29/27/25
	Heating		31/29/27/25
Sound Power Level	Cooling	H	60
	Heating		62
Airflow Rate	Cooling	H/M/L/Q	1,100/910/750/580
	Heating		1,100/910/750/580
Net Dimensions			mm 270 × 1,135 × 700
Weight			kg (lbs) 35 (77)
Connection Pipe Diameter	Liquid/Gas	mm	6.35/12.70
External static pressure			Pa 30 to 150
Drain pump			Standard

6-unit to 8-unit Multi-split Indoor Units Specifications

Compact wall-mounted



Model name	Indoor unit			ASYG07LUCA	ASYG09LUCA	ASYG12LUCA	ASYG14LUCA
kW Class	kW			2.0	2.5	3.5	4.0
Power Source	Single phase, ~230 V, 50 Hz						
Sound Pressure Level	Cooling	H/M/L/Q	dB(A)	35/30/28/21	36/32/28/21	37/34/31/21	41/36/33/25
	Heating			35/30/28/21	36/32/28/21	37/34/31/21	41/36/34/27
Sound Power Level	Cooling	H	dB(A)	53	54	55	59
	Heating			53	54	55	59
Airflow Rate	Cooling	H/M/L/Q	m³/h	570/520/470/330	600/550/470/330	660/600/530/330	710/640/570/390
	Heating			570/520/470/330	600/550/470/330	660/600/530/330	710/640/590/430
Net Dimensions	mm			282 × 870 × 185	282 × 870 × 185	282 × 870 × 185	282 × 870 × 185
Weight	kg (lbs)			9.5 (21)	9.5 (21)	9.5 (21)	9.5 (21)
Connection Pipe Diameter	Liquid/Gas	mm		6.35/9.52	6.35/9.52	6.35/9.52	6.35/12.70

Wall-mounted type



Model name	Indoor unit			ASYG18LFCA	ASYG24LFCC
kW Class	kW			5.0	7.0
Power Source	Single phase, ~230 V, 50 Hz				
Sound Pressure Level	Cooling	H/M/L/Q	dB(A)	43/37/33/26	49/42/37/33
	Heating			42/37/33/25	48/42/37/33
Sound Power Level	Cooling	H	dB(A)	58	64
	Heating			58	64
Airflow Rate	Cooling	H/M/L/Q	m³/h	900/740/620/550	1,120/900/740/620
	Heating			900/740/620/550	1,100/900/740/620
Net Dimensions	mm			320 × 998 × 238	320 × 998 × 238
Weight	kg (lbs)			14 (31)	14 (31)
Connection Pipe Diameter	Liquid/Gas	mm		6.35/12.70	6.35/15.88

Compact wall-mounted



Model name	Indoor unit			ASYG07LMCE	ASYG09LMCE	ASYG12LMCE	ASYG14LMCE
kW Class	kW			2.0	2.5	3.5	4.0
Power Source	Single phase, ~230 V, 50 Hz						
Sound Pressure Level	Cooling	H/M/L/Q	dB(A)	36/32/29/21	37/33/29/21	40/36/30/21	42/38/33/25
	Heating			36/32/29/22	37/33/29/22	40/36/31/22	42/38/35/27
Sound Power Level	Cooling	H	dB(A)	51	52	54	56
	Heating			51	52	55	57
Airflow Rate	Cooling	H/M/L/Q	m³/h	560/500/430/310	600/520/430/310	660/560/450/310	730/600/530/360
	Heating			560/500/430/330	600/520/430/330	660/560/470/330	730/615/560/375
Net Dimensions	mm			270 × 870 × 204	270 × 870 × 204	270 × 870 × 204	270 × 870 × 204
Weight	kg (lbs)			8.5 (19)	8.5 (19)	8.5 (19)	8.5 (19)
Connection Pipe Diameter	Liquid/Gas	mm		6.35/9.52	6.35/9.52	6.35/9.52	6.35/12.70

Floor



Model name	Indoor unit			AGYG09LVCA	AGYG12LVCA	AGYG14LVCA
kW Class	kW			2.5	3.5	4.0
Power Source	Single phase, ~230 V, 50 Hz					
Sound Pressure Level	Cooling	H/M/L/Q	dB(A)	39/34/28/22	42/36/30/22	44/38/31/22
	Heating			39/35/30/22	42/38/32/22	44/39/33/22
Sound Power Level	Cooling	H	dB(A)	52	55	56
	Heating			52	55	56
Airflow Rate	Cooling	H/M/L/Q	m³/h	530/440/360/270	600/490/380/270	650/520/400/270
	Heating			530/460/380/270	600/510/410/270	650/540/430/270
Net Dimensions	mm			600 × 740 × 200	600 × 740 × 200	600 × 740 × 200
Weight	kg (lbs)			14 (31)	14 (31)	14 (31)
Connection Pipe Diameter	Liquid/Gas	mm		6.35/9.52	6.35/9.52	6.35/12.70

Floor ceiling



Model name	Indoor unit			ABYG14LVTA	ABYG18LVTB
kW Class	kW			4.0	5.0
Power Source	Single phase, ~230 V, 50 Hz				
Sound Pressure Level	Cooling	H/M/L/Q	dB(A)	36/34/33/29 (Under ceiling) 39/37/36/32 (Floor console)	41/38/34/32 (Under ceiling) 44/41/37/35 (Floor console)
	Heating			36/34/33/29 (Under ceiling) 39/37/36/32 (Floor console)	41/38/34/32 (Under ceiling) 44/41/37/35 (Floor console)
Sound Power Level	Cooling	H	dB(A)	51	55
	Heating			51	55
Airflow Rate	Cooling	H/M/L/Q	m³/h	640/590/540/480	780/700/560/500
	Heating			640/590/540/480	780/700/560/500
Net Dimensions	mm			199 × 990 × 655	199 × 990 × 655
Weight	kg (lbs)			27 (60)	27 (60)
Connection Pipe Diameter	Liquid/Gas	mm		6.35/12.70	6.35/12.70

Compact cassette



Model name	Indoor unit			AUYG07LVLA	AUYG09LVLA	AUYG12LVLB	AUYG14LVLB	AUYG18LVLB
kW Class	kW			2.0	2.5	3.5	4.0	5.0
Power Source	Single phase, ~230 V, 50 Hz							
Sound Pressure Level	Cooling	H/M/L/Q	dB(A)	33/31/29/27	33/31/29/27	37/33/31/28	40/35/32/29	42/37/33/29
	Heating			34/32/29/27	34/32/29/27	37/33/31/28	40/37/34/29	44/40/37/30
Sound Power Level	Cooling	H	dB(A)	46	46	49	52	54
	Heating			47	47	49	52	56
Airflow Rate	Cooling	H/M/L/Q	m³/h	540/490/440/390	540/490/440/390	610/530/470/410	680/580/490/410	750/610/520/410
	Heating			540/490/440/390	540/490/440/390	610/530/470/410	700/620/550/430	800/710/600/450
Net Dimensions	mm			245 × 570 × 570	245 × 570 × 570	245 × 570 × 570	245 × 570 × 570	245 × 570 × 570
Weight	kg (lbs)			15 (33)	15 (33)	15 (33)	15 (33)	15 (33)
Panel				UTG-UFYD-W				
Connection Pipe Diameter	Liquid/Gas	mm		6.35/9.52	6.35/9.52	6.35/9.52	6.35/12.70	6.35/12.70

Mini duct



Model name	Indoor unit			ARYG07LSLAP	ARYG09LSLAP	ARYG12LSLAP	ARYG14LSLAP	ARYG18LSLAP
kW Class	kW			2.0	2.5	3.5	4.0	5.0
Power Source	Single phase, ~230 V, 50 Hz							
Sound Pressure Level	Cooling	H/M/L/Q	dB(A)	29/26/24/23	29/26/24/23	31/27/25/23	35/30/27/23	33/29/26/23
	Heating			29/26/24/23	29/26/24/23	31/27/25/23	35/30/27/23	33/29/26/23
Sound Power Level	Cooling	H	dB(A)	52	54	55	60	58
	Heating			53	56	57	62	59
Airflow Rate	Cooling	H/M/L/Q	m³/h	550/440/390/360	600/450/400/360	650/490/430/360	800/640/530/360	940/750/540/480
	Heating			550/440/390/360	600/450/400/360	650/490/430/360	800/640/530/360	940/750/540/480
Net Dimensions	mm			198 × 700 × 450	198 × 700 × 450	198 × 700 × 450	198 × 700 × 450	198 × 900 × 450
Weight	kg (lbs)			15.5 (33)				
Connection Pipe Diameter	Liquid/Gas	mm		6.35/9.52			6.35/12.70	
External static pressure	Pa			0 to 30			0 to 50	
Drain pump	Standard							

Slim duct



Model name	Indoor unit			ARYG07LLTA	ARYG09LLTA	ARYG12LLTB	ARYG14LLTB	ARYG18LLTB
kW Class	kW			2.0	2.5	3.5	4.0	5.0
Power Source	Single phase, ~230 V, 50 Hz							
Sound Pressure Level	Cooling	H/M/L/Q	dB(A)	28/26/25/24	28/27/26/25	29/28/27/26	32/30/28/26	32/31/30/29
	Heating			28/26/25/24	28/26/25/24	29/28/27/24	33/30/28/25	33/32/31/29
Sound Power Level	Cooling	H	dB(A)	57	57	58	60	58
	Heating			57	57	58	61	59
Airflow Rate	Cooling	H/M/L/Q	m³/h	550/490/470/440	600/550/500/450	650/600/550/480	800/700/600/480	940/880/820/750
	Heating			550/490/470/440	600/550/500/450	650/600/550/480	800/700/600/480	940/880/820/750
Net Dimensions	mm			198 × 700 × 620	198 × 700 × 620	198 × 700 × 620	198 × 700 × 620	198 × 900 × 620
Weight	kg (lbs)			17 (37)	19 (42)	19 (42)	19 (42)	23 (51)
Connection Pipe Diameter	Liquid/Gas	mm		6.35/9.52	6.35/9.52	6.35/9.52	6.35/12.7	6.35/12.70
External static pressure	Pa			0 to 90				
Drain pump	Standard							

2-unit Multi-split Combination Table-Cooling/Heating

2-unit Multi-split cooling

AOYG14KBTAAZ	Combination of Indoor Units		Cooling Operation				Seasonal Data			
			Cooling Capacity			Input Power (Min. - Max.) kW	EER	Pdesign kW	SEER	Energy efficiency class
			Unit 1 kW	Unit 2 kW	Total Capacity (Min. - Max.) kW					
2-unit connection	7	7	2.00	2.00	4.00 (1.4-4.6)	0.97 (0.25-1.20)	4.12	4.0	8.7	A+++
	7	9	1.75	2.25	4.00 (1.4-4.6)	0.97 (0.25-1.20)	4.12	4.0	8.7	A+++
	7	12	1.47	2.53	4.00 (1.4-4.6)	0.97 (0.25-1.20)	4.12	4.0	8.7	A+++
	9	9	2.00	2.00	4.00 (1.4-4.6)	0.97 (0.25-1.20)	4.12	4.0	8.7	A+++
	9	12	1.71	2.29	4.00 (1.4-4.6)	0.97 (0.25-1.20)	4.12	4.0	8.7	A+++

Notes: •7: 7000 Btu/h/9: 9000 Btu/h/12: 12000 Btu/h models
 •The above specifications apply when connected with a wall-mounted [KG] unit.
 •2 or more indoor units should be connected.
 •Cooling capacity is determined based on 27°CDB/19°CWB (indoor temperature) and 35°CDB (outdoor temperature).
 •Pipe Length: 5 m, Height difference: 0 m (Outdoor unit to Indoor unit)
 •Total capacity of indoor units connected must be between 4.0 kW and 6.0 kW.

AOYG18KBTAAZ	Combination of Indoor Units		Cooling Operation				Seasonal Data			
			Cooling Capacity			Input Power (Min. - Max.) kW	EER	Pdesign kW	SEER	Energy efficiency class
			Unit 1 kW	Unit 2 kW	Total Capacity (Min. - Max.) kW					
2-unit connection	7	7	2.00	2.00	4.00 (1.7-5.0)	0.92 (0.25-1.23)	4.35	4.0	8.8	A+++
	7	9	2.00	2.50	4.50 (1.7-5.7)	1.07 (0.25-1.45)	4.22	4.5	8.7	A+++
	7	12	1.84	3.16	5.00 (1.7-5.8)	1.24 (0.25-1.55)	4.03	5.0	8.6	A+++
	7	14	1.67	3.33	5.00 (1.7-5.8)	1.24 (0.25-1.55)	4.03	5.0	8.6	A+++
	9	9	2.50	2.50	5.00 (1.7-5.8)	1.24 (0.25-1.55)	4.03	5.0	8.6	A+++
	9	12	2.14	2.86	5.00 (1.7-5.8)	1.24 (0.25-1.55)	4.03	5.0	8.6	A+++
	9	14	1.96	3.04	5.00 (1.7-5.8)	1.24 (0.25-1.55)	4.03	5.0	8.6	A+++
	12	12	2.50	2.50	5.00 (1.7-5.8)	1.24 (0.25-1.55)	4.03	5.0	8.6	A+++
	12	14	2.31	2.69	5.00 (1.7-5.8)	1.24 (0.25-1.55)	4.03	5.0	8.6	A+++

Notes: •7: 7000 Btu/h/9: 9000 Btu/h/12: 12000 Btu/h/14: 14000 Btu/h models
 •The above specifications apply when connected with a wall-mounted [KG] unit.
 •2 or more indoor units should be connected.
 •Cooling capacity is determined based on 27°CDB/19°CWB (indoor temperature) and 35°CDB (outdoor temperature).
 •Pipe Length: 5 m, Height difference: 0 m (Outdoor unit to Indoor unit)
 •Total capacity of indoor units connected must be between 4.0 kW and 7.5 kW.

2-unit Multi-split heating

AOYG14KBTAAZ	Combination of Indoor Units		Heating Operation				Seasonal Data			
			Heating Capacity			Input Power (Min. - Max.) kW	COP	Pdesign kW	SCOP	Energy efficiency class
			Unit 1 kW	Unit 2 kW	Total Capacity (Min. - Max.) kW					
2-unit connection	7	7	2.20	2.20	4.40 (1.1-5.5)	0.95 (0.25-1.65)	4.63	3.5	4.7	A++
	7	9	1.92	2.48	4.40 (1.1-5.5)	0.95 (0.25-1.65)	4.63	3.5	4.7	A++
	7	12	1.62	2.78	4.40 (1.1-5.5)	0.95 (0.25-1.65)	4.63	3.5	4.7	A++
	9	9	2.20	2.20	4.40 (1.1-5.5)	0.95 (0.25-1.65)	4.63	3.5	4.7	A++
	9	12	1.89	2.51	4.40 (1.1-5.5)	0.95 (0.25-1.65)	4.63	3.5	4.7	A++

Notes: •7: 7000 Btu/h/9: 9000 Btu/h/12: 12000 Btu/h models
 •The above specifications apply when connected with a wall-mounted [KG] unit.
 •2 or more indoor units should be connected.
 •Heating capacity is determined based on 20°CDB (indoor temperature) and 7°CDB/6°CWB (outdoor temperature).
 •Pipe Length: 5 m, Height difference: 0 m (Outdoor unit to Indoor unit)
 •Total capacity of indoor units connected must be between 4.0 kW and 6.0 kW.

AOYG18KBTAAZ	Combination of Indoor Units		Heating Operation				Seasonal Data			
			Heating Capacity			Input Power (Min. - Max.) kW	COP	Pdesign kW	SCOP	Energy efficiency class
			Unit 1 kW	Unit 2 kW	Total Capacity (Min. - Max.) kW					
2-unit connection	7	7	2.40	2.40	4.80 (1.7-5.6)	0.99 (0.25-1.35)	4.85	3.8	4.7	A++
	7	9	2.40	3.00	5.40 (1.7-6.4)	1.15 (0.25-1.60)	4.70	4.0	4.7	A++
	7	12	2.06	3.54	5.60 (1.7-7.0)	1.22 (0.25-1.80)	4.59	4.2	4.7	A++
	7	14	1.87	3.73	5.60 (1.7-7.0)	1.22 (0.25-1.80)	4.59	4.2	4.7	A++
	9	9	2.80	2.80	5.60 (1.7-7.0)	1.22 (0.25-1.80)	4.59	4.2	4.7	A++
	9	12	2.40	3.20	5.60 (1.7-7.0)	1.22 (0.25-1.80)	4.59	4.2	4.7	A++
	9	14	2.19	3.41	5.60 (1.7-7.0)	1.22 (0.25-1.80)	4.59	4.2	4.7	A++
	12	12	2.80	2.80	5.60 (1.7-7.0)	1.22 (0.25-1.80)	4.59	4.2	4.7	A++
	12	14	2.58	3.02	5.60 (1.7-7.0)	1.22 (0.25-1.80)	4.59	4.2	4.7	A++

Notes: •7: 7000 Btu/h/9: 9000 Btu/h/12: 12000 Btu/h/14: 14000 Btu/h models
 •The above specifications apply when connected with a wall-mounted [KG] unit.
 •2 or more indoor units should be connected.
 •Heating capacity is determined based on 20°CDB (indoor temperature) and 7°CDB/6°CWB (outdoor temperature).
 •Pipe Length: 5 m, Height difference: 0 m (Outdoor unit to Indoor unit)
 •Total capacity of indoor units connected must be between 4.0 kW and 7.5 kW.

3-unit Multi-split Combination Table-Cooling/Heating

3-unit Multi-split cooling

AOYG18KBTA3	Combination of Indoor Units			Cooling Operation					Seasonal Data			
				Cooling Capacity			Input Power (Min. - Max.) kW	EER	Pdesign kW	SEER	Energy efficiency	
				Unit 1 kW	Unit 2 kW	Unit 3 kW						Total Capacity (Min. - Max.) kW
2-unit connection	7	7	-	2.00	2.00	-	4.00 (1.8-5.0)	0.86 (0.35-1.35)	4.65	4.0	8.3	A++
	7	9	-	2.00	2.50	-	4.50 (1.8-5.7)	1.03 (0.35-1.54)	4.36	4.5	8.2	A++
	7	12	-	1.99	3.41	-	5.40 (1.8-6.8)	1.41 (0.35-1.85)	3.83	5.4	8.0	A++
	7	14	-	1.80	3.60	-	5.40 (1.8-7.0)	1.41 (0.35-1.90)	3.83	5.4	8.0	A++
	9	9	-	2.50	2.50	-	5.00 (1.8-6.4)	1.23 (0.35-1.74)	4.06	5.0	8.1	A++
	9	12	-	2.31	3.09	-	5.40 (1.8-7.0)	1.41 (0.35-1.90)	3.83	5.4	8.0	A++
	9	14	-	2.11	3.29	-	5.40 (1.8-7.0)	1.41 (0.35-1.90)	3.83	5.4	8.0	A++
	12	12	-	2.70	2.70	-	5.40 (1.8-7.0)	1.41 (0.35-1.90)	3.83	5.4	8.0	A++
	12	14	-	2.49	2.91	-	5.40 (1.8-7.0)	1.41 (0.35-1.90)	3.83	5.4	8.0	A++
	14	14	-	2.70	2.70	-	5.40 (1.8-7.0)	1.41 (0.35-1.90)	3.83	5.4	8.0	A++
	7	7	7	1.80	1.80	1.80	5.40 (1.8-7.0)	1.13 (0.35-1.90)	4.78	5.4	8.6	A+++
	7	7	9	1.64	1.64	2.12	5.40 (1.8-7.0)	1.13 (0.35-1.90)	4.78	5.4	8.6	A+++
3-unit connection	7	7	12	1.45	1.45	2.50	5.40 (1.8-7.0)	1.13 (0.35-1.90)	4.78	5.4	8.6	A+++
	7	7	14	1.35	1.35	2.70	5.40 (1.8-7.0)	1.13 (0.35-1.90)	4.78	5.4	8.6	A+++
	7	9	9	1.52	1.94	1.94	5.40 (1.8-7.0)	1.13 (0.35-1.90)	4.78	5.4	8.6	A+++
	7	9	12	1.35	1.74	2.31	5.40 (1.8-7.0)	1.13 (0.35-1.90)	4.78	5.4	8.6	A+++
	7	9	14	1.26	1.62	2.52	5.40 (1.8-7.0)	1.13 (0.35-1.90)	4.78	5.4	8.6	A+++
	9	9	9	1.80	1.80	1.80	5.40 (1.8-7.0)	1.13 (0.35-1.90)	4.78	5.4	8.6	A+++
	9	9	12	1.62	1.62	2.16	5.40 (1.8-7.0)	1.13 (0.35-1.90)	4.78	5.4	8.6	A+++

AOYG24KBTA3	Combination of Indoor Units			Cooling Operation					Seasonal Data				
				Cooling Capacity			Input Power (Min. - Max.) kW	EER	Pdesign kW	SEER	Energy efficiency		
				Unit 1 kW	Unit 2 kW	Unit 3 kW						Total Capacity (Min. - Max.) kW	
2-unit connection	7	7	-	2.00	2.00	-	4.00 (1.8-5.0)	0.86 (0.35-1.35)	4.65	4.0	8.3	A++	
	7	9	-	2.00	2.50	-	4.50 (1.8-5.7)	1.03 (0.35-1.54)	4.36	4.5	8.2	A++	
	7	12	-	2.00	3.50	-	5.50 (1.8-6.8)	1.46 (0.35-1.85)	3.77	5.5	8.0	A++	
	7	14	-	2.00	4.00	-	6.00 (1.8-7.5)	1.73 (0.35-2.20)	3.48	6.0	7.6	A++	
	7	18	-	1.90	4.90	-	6.80 (1.8-8.5)	2.26 (0.35-2.65)	3.01	6.8	6.9	A++	
	9	9	-	2.50	2.50	-	5.00 (1.8-6.4)	1.23 (0.35-1.74)	4.06	5.0	8.1	A++	
	9	12	-	2.50	3.50	-	6.00 (1.8-7.5)	1.73 (0.35-2.20)	3.48	6.0	7.6	A++	
	9	14	-	2.50	4.00	-	6.50 (1.8-8.2)	2.04 (0.35-2.46)	3.19	6.5	7.2	A++	
	9	18	-	2.27	4.53	-	6.80 (1.8-8.5)	2.26 (0.35-2.65)	3.01	6.8	6.9	A++	
	12	12	-	3.40	3.40	-	6.80 (1.8-8.5)	2.26 (0.35-2.65)	3.01	6.8	6.9	A++	
	12	14	-	3.14	3.66	-	6.80 (1.8-8.5)	2.26 (0.35-2.65)	3.01	6.8	6.9	A++	
	12	18	-	2.72	4.08	-	6.80 (1.8-8.5)	2.26 (0.35-2.65)	3.01	6.8	6.9	A++	
	14	14	-	3.40	3.40	-	6.80 (1.8-8.5)	2.26 (0.35-2.65)	3.01	6.8	6.9	A++	
	14	18	-	2.98	3.82	-	6.80 (1.8-8.5)	2.26 (0.35-2.65)	3.01	6.8	6.9	A++	
	3-unit connection	7	7	7	2.00	2.00	2.00	6.00 (1.8-7.5)	1.37 (0.35-2.20)	4.37	6.0	8.6	A+++
		7	7	9	2.00	2.00	2.50	6.50 (1.8-8.2)	1.59 (0.35-2.46)	4.08	6.5	8.5	A+++
7		7	12	1.83	1.83	3.14	6.80 (1.8-8.5)	1.74 (0.35-2.65)	3.90	6.8	8.5	A+++	
7		7	14	1.70	1.70	3.40	6.80 (1.8-8.5)	1.74 (0.35-2.65)	3.90	6.8	8.5	A+++	
7		7	18	1.49	1.49	3.82	6.80 (1.8-8.5)	1.74 (0.35-2.65)	3.90	6.8	8.5	A+++	
7		9	9	1.90	2.45	2.45	6.80 (1.8-8.5)	1.74 (0.35-2.65)	3.90	6.8	8.5	A+++	
7		9	12	1.70	2.19	2.91	6.80 (1.8-8.5)	1.74 (0.35-2.65)	3.90	6.8	8.5	A+++	
7		9	14	1.59	2.04	3.17	6.80 (1.8-8.5)	1.74 (0.35-2.65)	3.90	6.8	8.5	A+++	
7		9	18	1.40	1.80	3.60	6.80 (1.8-8.5)	1.74 (0.35-2.65)	3.90	6.8	8.5	A+++	
7		12	12	1.54	2.63	2.63	6.80 (1.8-8.5)	1.74 (0.35-2.65)	3.90	6.8	8.5	A+++	
7		12	14	1.44	2.47	2.89	6.80 (1.8-8.5)	1.74 (0.35-2.65)	3.90	6.8	8.5	A+++	
7		14	14	1.36	2.72	2.72	6.80 (1.8-8.5)	1.74 (0.35-2.65)	3.90	6.8	8.5	A+++	
9		9	9	2.27	2.27	2.27	6.80 (1.8-8.5)	1.74 (0.35-2.65)	3.90	6.8	8.5	A+++	
9		9	12	2.04	2.04	2.72	6.80 (1.8-8.5)	1.74 (0.35-2.65)	3.90	6.8	8.5	A+++	
9		9	14	1.91	1.91	2.98	6.80 (1.8-8.5)	1.74 (0.35-2.65)	3.90	6.8	8.5	A+++	
9		9	18	1.70	1.70	3.40	6.80 (1.8-8.5)	1.74 (0.35-2.65)	3.90	6.8	8.5	A+++	
9		12	12	1.86	2.47	2.47	6.80 (1.8-8.5)	1.74 (0.35-2.65)	3.90	6.8	8.5	A+++	
9		12	14	1.75	2.33	2.72	6.80 (1.8-8.5)	1.74 (0.35-2.65)	3.90	6.8	8.5	A+++	
12		12	12	2.27	2.27	2.27	6.80 (1.8-8.5)	1.74 (0.35-2.65)	3.90	6.8	8.5	A+++	

Notes: •7: 7000 Btu/h/9: 9000 Btu/h/12: 12000 Btu/h/14: 14000 Btu/h/18: 18000 Btu/h models
 •The above specifications apply when connected with a wall-mounted unit.
 •2 or more indoor units should be connected.
 •Cooling capacity is determined based on 27°CDB/19°CWB (indoor temperature) and 35°CDB (outdoor temperature).
 •Pipe Length: 5 m, Height difference: 0 m (Outdoor unit to Indoor unit)
 •Total capacity of indoor units connected must be between 4.0 kW and 10.5 kW.

3-unit Multi-split heating

AOYG18KBTA3	Combination of Indoor Units			Heating Operation					Seasonal Data			
				Heating Capacity			Input Power (Min. - Max.) kW	COP	Pdesign kW	SCOP	Energy efficiency	
				Unit 1 kW	Unit 2 kW	Unit 3 kW						Total Capacity (Min. - Max.) kW
2-unit connection	7	7	-	2.40	2.40	-	4.80 (2.0-5.6)	1.00 (0.25-1.30)	4.80	4.0	4.2	A+
	7	9	-	2.40	3.00	-	5.40 (2.0-6.4)	1.21 (0.25-1.48)	4.45	4.0	4.2	A+
	7	12	-	2.40	4.20	-	6.60 (2.0-7.6)	1.66 (0.25-1.76)	3.98	5.0	4.0	A+
	7	14	-	2.27	4.53	-	6.80 (2.0-8.0)	1.77 (0.25-1.85)	3.84	5.0	4.0	A+
	9	9	-	3.00	3.00	-	6.00 (2.0-7.2)	1.44 (0.25-1.67)	4.17	4.5	4.1	A+
	9	12	-	2.91	3.89	-	6.80 (2.0-8.0)	1.77 (0.25-1.85)	3.84	5.0	4.0	A+
	9	14	-	2.66	4.14	-	6.80 (2.0-8.0)	1.77 (0.25-1.85)	3.84	5.0	4.0	A+
	12	12	-	3.40	3.40	-	6.80 (2.0-8.0)	1.77 (0.25-1.85)	3.84	5.0	4.0	A+
	12	14	-	3.14	3.66	-	6.80 (2.0-8.0)	1.77 (0.25-1.85)	3.84	5.0	4.0	A+
	14	14	-	3.40	3.40	-	6.80 (2.0-8.0)	1.77 (0.25-1.85)	3.84	5.0	4.0	A+
	7	7	7	2.27	2.27	2.27	6.80 (2.0-8.0)	1.39 (0.25-1.85)	4.89	5.0	4.7	A++
	7	7	9	2.07	2.07	2.66	6.80 (2.0-8.0)	1.39 (0.25-1.85)	4.89	5.0	4.7	A++
3-unit connection	7	7	12	1.83	1.83	3.14	6.80 (2.0-8.0)	1.39 (0.25-1.85)	4.89	5.0	4.7	A++
	7	7	14	1.70	1.70	3.40	6.80 (2.0-8.0)	1.39 (0.25-1.85)	4.89	5.0	4.7	A++
	7	9	9	1.90	2.45	2.45	6.80 (2.0-8.0)	1.39 (0.25-1.85)	4.89	5.0	4.7	A++
	7	9	12	1.70	2.19	2.91	6.80 (2.0-8.0)	1.39 (0.25-1.85)	4.89	5.0	4.7	A++
	7	9	14	1.59	2.04	3.17	6.80 (2.0-8.0)	1.39 (0.25-1.85)	4.89	5.0	4.7	A++
	9	9	9	2.27	2.27	2.27	6.80 (2.0-8.0)	1.39 (0.25-1.85)	4.89	5.0	4.7	A++
	9	9	12	2.04	2.04	2.72	6.80 (2.0-8.0)	1.39 (0.25-1.85)	4.89	5.0	4.7	A++

AOYG24KBTA3	Combination of Indoor Units			Heating Operation					Seasonal Data				
				Heating Capacity			Input Power (Min. - Max.) kW	COP	Pdesign kW	SCOP	Energy efficiency		
				Unit 1 kW	Unit 2 kW	Unit 3 kW						Total Capacity (Min. - Max.) kW	
2-unit connection	7	7	-	2.40	2.40	-	4.80 (2.0-5.6)	1.00 (0.25-1.30)	4.80	4.0	4.2	A+	
	7	9	-	2.40	3.00	-	5.40 (2.0-6.4)	1.21 (0.25-1.48)	4.45	4.0	4.2	A+	
	7	12	-	2.40	4.20	-	6.60 (2.0-7.6)	1.66 (0.25-1.76)	3.98	5.0	4.0	A+	
	7	14	-	2.40	4.80	-	7.20 (2.0-8.4)	1.86 (0.25-2.07)	3.87	5.4	4.0	A+	
	7	18	-	2.16	5.54	-	7.70 (2.0-9.2)	2.01 (0.25-2.35)	3.83	5.8	4.0	A+	
	9	9	-	3.00	3.00	-	6.00 (2.0-7.2)	1.44 (0.25-1.67)	4.17	4.5	4.1	A+	
	9	12	-	3.00	4.20	-	7.20 (2.0-8.4)	1.86 (0.25-2.07)	3.87	5.4	4.0	A+	
	9	14	-	2.96	4.74	-	7.70 (2.0-9.2)	2.01 (0.25-2.35)	3.83	5.8	4.0	A+	
	9	18	-	2.57	5.13	-	7.70 (2.0-9.2)	2.01 (0.25-2.35)	3.83	5.8	4.0	A+	
	12	12	-	3.85	3.85	-	7.70 (2.0-9.2)	2.01 (0.25-2.35)	3.83	5.8	4.0	A+	
	12	14	-	3.55	4.15	-	7.70 (2.0-9.2)	2.01 (0.25-2.35)	3.83	5.8	4.0	A+	
	12	18	-	3.08	4.62	-	7.70 (2.0-9.2)	2.01 (0.25-2.35)	3.83	5.8	4.0	A+	
	14	14	-	3.85	3.85	-	7.70 (2.0-9.2)	2.01 (0.25-2.35)	3.83	5.8	4.0	A+	
	14	18	-	3.37	4.33	-	7.70 (2.0-9.2)	2.01 (0.25-2.35)	3.83	5.8	4.0	A+	
	3-unit connection	7	7	7	2.40	2.40	2.40	7.20 (2.0-8.4)	1.61 (0.25-2.07)	4.48	5.4	4.7	A++
		7	7	9	2.40	2.40	3.00	7.80 (2.0-9.2)	1.76 (0.25-2.35)	4.42	5.8	4.6	A++
7		7	12	2.15	2.15	3.70	8.00 (2.0-9.2)	1.82 (0.25-2.35)	4.40	6.0	4.6	A++	
7		7	14	2.00	2.00	4.00	8.00 (2.0-9.2)	1.82 (0.25-2.35)	4.40	6.0	4.6	A++	
7		7	18	1.75	1.75	4.50	8.00 (2.0-9.2)	1.82 (0.25-2.35)	4.40	6.0	4.6	A++	
7		9	9	2.24	2.88	2.88	8.00 (2.0-9.2)	1.82 (0.25-2.35)	4.40	6.0	4.6	A++	
7		9	12	2.00	2.57	3.43	8.00 (2.0-9.2)	1.82 (0.25-2.35)	4.40	6.0	4.6	A++	
7		9	14	1.87	2.40	3.73	8.00 (2.0-9.2)	1.82 (0.25-2.35)	4.40	6.0	4.6	A++	
7		9	18	1.65	2.12	4.23	8.00 (2.0-9.2)	1.82 (0.25-2.35)	4.40	6.0	4.6	A++	
7		12	1										

5-unit Multi-split Combination Table-Cooling

5-unit Multi-split cooling

AOYG36K8TA5	Combination of Indoor Units					Cooling Operation						Seasonal Data								
						Cooling Capacity					Input Power (Min. - Max.)	EER	Pdesign kW	SEER	Energy efficiency					
						Unit 1	Unit 2	Unit 3	Unit 4	Unit 5						Total Capacity (Min. - Max.)				
						kW	kW	kW	kW	kW	kW									
2-unit connection	7	24	-	-	-	2.00	7.00	-	-	-	9.00 (3.0-11.0)	2.91 (0.30-3.45)	3.09	9.0	7.9	A++				
	9	22	-	-	-	2.50	6.00	-	-	-	8.50 (3.0-11.0)	2.67 (0.30-3.45)	3.18	8.5	7.9	A++				
	9	24	-	-	-	2.50	7.00	-	-	-	9.50 (3.0-11.0)	3.17 (0.30-3.45)	3.00	9.5	7.8	A++				
	12	22	-	-	-	3.50	6.00	-	-	-	9.50 (3.0-11.0)	3.17 (0.30-3.45)	3.00	9.5	7.8	A++				
	12	24	-	-	-	3.17	6.33	-	-	-	9.50 (3.0-11.0)	3.17 (0.30-3.45)	3.00	9.5	7.8	A++				
	14	22	-	-	-	3.69	5.61	-	-	-	9.50 (3.0-11.0)	3.17 (0.30-3.45)	3.00	9.5	7.8	A++				
	14	24	-	-	-	3.50	6.00	-	-	-	9.50 (3.0-11.0)	3.17 (0.30-3.45)	3.00	9.5	7.8	A++				
	18	18	-	-	-	4.75	4.75	-	-	-	9.50 (3.0-11.0)	3.17 (0.30-3.45)	3.00	9.5	7.8	A++				
	18	22	-	-	-	4.27	5.23	-	-	-	9.50 (3.0-11.0)	3.17 (0.30-3.45)	3.00	9.5	7.8	A++				
	18	24	-	-	-	4.07	5.43	-	-	-	9.50 (3.0-11.0)	3.17 (0.30-3.45)	3.00	9.5	7.8	A++				
	22	22	-	-	-	4.75	4.75	-	-	-	9.50 (3.0-11.0)	3.17 (0.30-3.45)	3.00	9.5	7.8	A++				
	22	24	-	-	-	4.54	4.96	-	-	-	9.50 (3.0-11.0)	3.17 (0.30-3.45)	3.00	9.5	7.8	A++				
	24	24	-	-	-	4.75	4.75	-	-	-	9.50 (3.0-11.0)	3.17 (0.30-3.45)	3.00	9.5	7.8	A++				
	3-unit connection	7	7	14	-	-	2.00	2.00	4.00	-	-	8.00 (3.0-10.0)	2.26 (0.30-2.88)	3.54	8.0	8.2	A++			
		7	7	18	-	-	2.00	2.00	5.00	-	-	9.00 (3.0-11.0)	2.68 (0.30-3.45)	3.36	9.0	8.1	A++			
		7	7	22	-	-	1.85	1.85	5.80	-	-	9.50 (3.0-11.0)	2.91 (0.30-3.45)	3.27	9.5	8.0	A++			
		7	7	24	-	-	1.75	1.75	6.00	-	-	9.50 (3.0-11.0)	2.91 (0.30-3.45)	3.27	9.5	8.0	A++			
		7	9	12	-	-	2.00	2.50	3.50	-	-	8.00 (3.0-10.0)	2.26 (0.30-2.88)	3.54	8.0	8.2	A++			
		7	9	14	-	-	2.00	2.50	4.00	-	-	8.50 (3.0-10.7)	2.46 (0.30-3.27)	3.45	8.5	8.1	A++			
		7	9	18	-	-	2.00	2.50	5.00	-	-	9.50 (3.0-11.0)	2.91 (0.30-3.45)	3.27	9.5	8.0	A++			
		7	9	22	-	-	1.75	2.25	5.50	-	-	9.50 (3.0-11.0)	2.91 (0.30-3.45)	3.27	9.5	8.0	A++			
		7	9	24	-	-	1.66	2.14	5.70	-	-	9.50 (3.0-11.0)	2.91 (0.30-3.45)	3.27	9.5	8.0	A++			
		7	12	12	-	-	2.00	3.50	3.50	-	-	9.50 (3.0-11.0)	2.68 (0.30-3.45)	3.36	9.0	8.1	A++			
		7	12	14	-	-	2.00	3.50	4.00	-	-	9.50 (3.0-11.0)	2.91 (0.30-3.45)	3.27	9.5	8.0	A++			
7		12	18	-	-	1.80	3.08	4.62	-	-	9.50 (3.0-11.0)	2.91 (0.30-3.45)	3.27	9.5	8.0	A++				
7		12	22	-	-	1.62	2.78	5.10	-	-	9.50 (3.0-11.0)	2.91 (0.30-3.45)	3.27	9.5	8.0	A++				
7		12	24	-	-	1.55	2.65	5.30	-	-	9.50 (3.0-11.0)	2.91 (0.30-3.45)	3.27	9.5	8.0	A++				
7		14	14	-	-	1.90	3.80	3.80	-	-	9.50 (3.0-11.0)	2.91 (0.30-3.45)	3.27	9.5	8.0	A++				
7		14	18	-	-	1.71	3.41	4.38	-	-	9.50 (3.0-11.0)	2.91 (0.30-3.45)	3.27	9.5	8.0	A++				
7		14	22	-	-	1.55	3.09	4.86	-	-	9.50 (3.0-11.0)	2.91 (0.30-3.45)	3.27	9.5	8.0	A++				
7		14	24	-	-	1.47	2.96	5.07	-	-	9.50 (3.0-11.0)	2.91 (0.30-3.45)	3.27	9.5	8.0	A++				
7		18	18	-	-	1.54	3.98	3.98	-	-	9.50 (3.0-11.0)	2.91 (0.30-3.45)	3.27	9.5	8.0	A++				
7		18	22	-	-	1.41	3.64	4.45	-	-	9.50 (3.0-11.0)	2.91 (0.30-3.45)	3.27	9.5	8.0	A++				
7		18	24	-	-	1.36	3.49	4.65	-	-	9.50 (3.0-11.0)	2.91 (0.30-3.45)	3.27	9.5	8.0	A++				
9		9	9	-	-	2.50	2.50	2.50	-	-	7.50 (3.0-9.6)	2.07 (0.30-2.70)	3.63	7.5	8.2	A++				
9		9	12	-	-	2.50	2.50	3.50	-	-	8.50 (3.0-10.7)	2.46 (0.30-3.27)	3.45	8.5	8.1	A++				
9		9	14	-	-	2.50	2.50	4.00	-	-	9.00 (3.0-11.0)	2.68 (0.30-3.45)	3.36	9.0	8.1	A++				
9	9	18	-	-	2.38	2.38	4.74	-	-	9.50 (3.0-11.0)	2.91 (0.30-3.45)	3.27	9.5	8.0	A++					
9	9	22	-	-	2.14	2.14	5.22	-	-	9.50 (3.0-11.0)	2.91 (0.30-3.45)	3.27	9.5	8.0	A++					
9	9	24	-	-	2.04	2.04	5.42	-	-	9.50 (3.0-11.0)	2.91 (0.30-3.45)	3.27	9.5	8.0	A++					
9	12	12	-	-	3.50	3.50	3.50	-	-	9.50 (3.0-11.0)	2.91 (0.30-3.45)	3.27	9.5	8.0	A++					
9	12	14	-	-	2.44	3.26	3.80	-	-	9.50 (3.0-11.0)	2.91 (0.30-3.45)	3.27	9.5	8.0	A++					
9	12	18	-	-	2.19	2.92	4.39	-	-	9.50 (3.0-11.0)	2.91 (0.30-3.45)	3.27	9.5	8.0	A++					
9	12	22	-	-	1.99	2.65	4.86	-	-	9.50 (3.0-11.0)	2.91 (0.30-3.45)	3.27	9.5	8.0	A++					
9	12	24	-	-	1.90	2.53	5.07	-	-	9.50 (3.0-11.0)	2.91 (0.30-3.45)	3.27	9.5	8.0	A++					
9	14	14	-	-	2.32	3.59	3.59	-	-	9.50 (3.0-11.0)	2.91 (0.30-3.45)	3.27	9.5	8.0	A++					
9	14	18	-	-	2.09	3.24	4.17	-	-	9.50 (3.0-11.0)	2.91 (0.30-3.45)	3.27	9.5	8.0	A++					
9	14	22	-	-	1.90	2.96	4.64	-	-	9.50 (3.0-11.0)	2.91 (0.30-3.45)	3.27	9.5	8.0	A++					
9	14	24	-	-	1.82	2.83	4.85	-	-	9.50 (3.0-11.0)	2.91 (0.30-3.45)	3.27	9.5	8.0	A++					
9	18	18	-	-	1.90	3.80	3.80	-	-	9.50 (3.0-11.0)	2.91 (0.30-3.45)	3.27	9.5	8.0	A++					
9	18	22	-	-	1.74	3.49	4.27	-	-	9.50 (3.0-11.0)	2.91 (0.30-3.45)	3.27	9.5	8.0	A++					
9	18	24	-	-	1.68	3.35	4.47	-	-	9.50 (3.0-11.0)	2.91 (0.30-3.45)	3.27	9.5	8.0	A++					
12	12	12	-	-	3.17	3.17	3.17	-	-	9.50 (3.0-11.0)	2.91 (0.30-3.45)	3.27	9.5	8.0	A++					
12	12	14	-	-	3.00	3.00	3.50	-	-	9.50 (3.0-11.0)	2.91 (0.30-3.45)	3.27	9.5	8.0	A++					
12	12	18	-	-	2.71	2.71	4.08	-	-	9.50 (3.0-11.0)	2.91 (0.30-3.45)	3.27	9.5	8.0	A++					
12	12	22	-	-	2.48	2.48	4.54	-	-	9.50 (3.0-11.0)	2.91 (0.30-3.45)	3.27	9.5	8.0	A++					
12	12	24	-	-	2.38	2.38	4.74	-	-	9.50 (3.0-11.0)	2.91 (0.30-3.45)	3.27	9.5	8.0	A++					
12	14	14	-	-	2.84	3.33	3.33	-	-	9.50 (3.0-11.0)	2.91 (0.30-3.45)	3.27	9.5	8.0	A++					
12	14	18	-	-	2.59	3.02	3.89	-	-	9.50 (3.0-11.0)	2.91 (0.30-3.45)	3.27	9.5	8.0	A++					
12	14	22	-	-	2.38	2.77	4.35	-	-	9.50 (3.0-11.0)	2.91 (0.30-3.45)	3.27	9.5	8.0	A++					
12	14	24	-	-	2.28	2.66	4.56	-	-	9.50 (3.0-11.0)	2.91 (0.30-3.45)	3.27	9.5	8.0	A++					
12	18	18	-	-	2.38	3.56	3.56	-	-	9.50 (3.0-11.0)	2.91 (0.30-3.45)	3.27	9.5	8.0	A++					
12	18	22	-	-	2.19	3.29	4.02	-	-	9.50 (3.0-11.0)	2.91 (0.30-3.45)	3.27	9.5	8.0	A++					
12	18	24	-	-	2.11	3.17	4.22	-	-	9.50 (3.0-11.0)	2.91 (0.30-3.45)	3.27	9.5	8.0	A++					
14	14	14	-	-	3.17	3.17	3.17	-	-	9.50 (3.0-11.0)	2.91 (0.30-3.45)	3.27	9.5	8.0	A++					
14	14	18	-	-	2.89	2.89	3.72	-	-	9.50 (3.0-11.0)	2.91 (0.30-3.45)	3.27	9.5	8.0	A++					
14	14	22	-	-	2.66	2.66	4.18	-	-	9.50 (3.0-11.0)	2.91 (0.30-3.45)	3.27	9.5	8.0	A++					
14	14	24	-	-	2.56	2.56	4.38	-	-	9.50 (3.0-11.0)	2.91 (0.30-3.45)	3.27	9.5	8.0	A++					
14	18	18	-	-	2.66	3.42	3.42	-	-	9.50 (3.0-11.0)	2.91 (0.3									



5-unit Multi-split Combination Table-Heating

5-unit Multi-split heating

AOYG36KBTAS	Combination of Indoor Units					Heating Operation						Seasonal Data				
						Heating Capacity					Input Power (Min. - Max.)	COP	Pdesign kW	SCOP	Energy efficiency	
						Unit 1	Unit 2	Unit 3	Unit 4	Unit 5						Total Capacity (Min. - Max.)
2-unit connection	7	24	-	-	-	2.39	8.21	-	-	-	10.60 (3.5-12.0)	2.65 (0.25-3.25)	4.00	7.0	4.3	A+
	9	22	-	-	-	3.00	7.20	-	-	-	10.20 (3.5-12.0)	2.52 (0.25-3.25)	4.04	6.8	4.3	A+
	9	24	-	-	-	2.89	7.71	-	-	-	10.60 (3.5-12.0)	2.65 (0.25-3.25)	4.00	7.0	4.3	A+
	12	22	-	-	-	3.74	6.86	-	-	-	10.60 (3.5-12.0)	2.65 (0.25-3.25)	4.00	7.0	4.3	A+
	12	24	-	-	-	3.53	7.07	-	-	-	10.60 (3.5-12.0)	2.65 (0.25-3.25)	4.00	7.0	4.3	A+
	14	24	-	-	-	4.12	3.68	-	-	-	10.60 (3.5-12.0)	2.65 (0.25-3.25)	4.00	7.0	4.3	A+
	14	24	-	-	-	3.91	6.69	-	-	-	10.60 (3.5-12.0)	2.65 (0.25-3.25)	4.00	7.0	4.3	A+
	18	18	-	-	-	5.30	5.30	-	-	-	10.60 (3.5-12.0)	2.65 (0.25-3.25)	4.00	7.0	4.3	A+
	18	22	-	-	-	4.77	5.83	-	-	-	10.60 (3.5-12.0)	2.65 (0.25-3.25)	4.00	7.0	4.3	A+
	18	24	-	-	-	4.54	6.06	-	-	-	10.60 (3.5-12.0)	2.65 (0.25-3.25)	4.00	7.0	4.3	A+
	22	22	-	-	-	5.30	5.30	-	-	-	10.60 (3.5-12.0)	2.65 (0.25-3.25)	4.00	7.0	4.3	A+
	22	24	-	-	-	5.07	5.53	-	-	-	10.60 (3.5-12.0)	2.65 (0.25-3.25)	4.00	7.0	4.3	A+
	24	24	-	-	-	5.30	5.30	-	-	-	10.60 (3.5-12.0)	2.65 (0.25-3.25)	4.00	7.0	4.3	A+
	7	7	14	-	-	2.40	2.40	4.80	-	-	9.60 (3.5-11.2)	2.25 (0.25-2.87)	4.26	6.5	4.5	A+
	7	7	18	-	-	2.32	2.32	5.96	-	-	10.60 (3.5-12.0)	2.54 (0.25-3.25)	4.18	7.0	4.4	A+
	7	7	22	-	-	2.06	2.06	6.48	-	-	10.60 (3.5-12.0)	2.54 (0.25-3.25)	4.18	7.0	4.4	A+
	7	7	24	-	-	1.95	1.95	6.70	-	-	10.60 (3.5-12.0)	2.54 (0.25-3.25)	4.18	7.0	4.4	A+
	7	9	12	-	-	2.40	3.00	4.20	-	-	9.60 (3.5-11.2)	2.25 (0.25-2.87)	4.26	6.5	4.5	A+
	7	9	14	-	-	2.40	3.00	4.80	-	-	10.20 (3.5-12.0)	2.42 (0.25-3.25)	4.21	6.8	4.4	A+
	7	9	18	-	-	2.18	2.81	5.61	-	-	10.60 (3.5-12.0)	2.54 (0.25-3.25)	4.18	7.0	4.4	A+
	7	9	22	-	-	1.95	2.51	6.14	-	-	10.60 (3.5-12.0)	2.54 (0.25-3.25)	4.18	7.0	4.4	A+
	7	9	24	-	-	1.85	2.39	6.36	-	-	10.60 (3.5-12.0)	2.54 (0.25-3.25)	4.18	7.0	4.4	A+
	7	12	12	-	-	1.72	4.44	4.44	-	-	10.60 (3.5-12.0)	2.54 (0.25-3.25)	4.18	7.0	4.4	A+
	7	12	14	-	-	2.25	3.85	4.50	-	-	10.60 (3.5-12.0)	2.54 (0.25-3.25)	4.18	7.0	4.4	A+
7	12	18	-	-	2.00	3.44	5.16	-	-	10.60 (3.5-12.0)	2.54 (0.25-3.25)	4.18	7.0	4.4	A+	
7	12	22	-	-	1.81	3.10	5.69	-	-	10.60 (3.5-12.0)	2.54 (0.25-3.25)	4.18	7.0	4.4	A+	
7	12	24	-	-	1.72	2.96	5.92	-	-	10.60 (3.5-12.0)	2.54 (0.25-3.25)	4.18	7.0	4.4	A+	
7	14	14	-	-	2.12	4.24	4.24	-	-	10.60 (3.5-12.0)	2.54 (0.25-3.25)	4.18	7.0	4.4	A+	
7	14	18	-	-	1.90	3.81	4.89	-	-	10.60 (3.5-12.0)	2.54 (0.25-3.25)	4.18	7.0	4.4	A+	
7	14	22	-	-	1.73	3.45	5.42	-	-	10.60 (3.5-12.0)	2.54 (0.25-3.25)	4.18	7.0	4.4	A+	
7	14	24	-	-	1.65	3.30	5.65	-	-	10.60 (3.5-12.0)	2.54 (0.25-3.25)	4.18	7.0	4.4	A+	
7	18	18	-	-	1.72	4.44	4.44	-	-	10.60 (3.5-12.0)	2.54 (0.25-3.25)	4.18	7.0	4.4	A+	
7	18	22	-	-	1.58	4.06	4.96	-	-	10.60 (3.5-12.0)	2.54 (0.25-3.25)	4.18	7.0	4.4	A+	
7	18	24	-	-	1.51	3.89	5.20	-	-	10.60 (3.5-12.0)	2.54 (0.25-3.25)	4.18	7.0	4.4	A+	
9	9	9	-	-	3.00	3.00	3.00	-	-	9.00 (3.5-10.8)	2.09 (0.25-2.70)	4.31	6.0	4.5	A+	
9	9	12	-	-	3.00	3.00	4.20	-	-	10.20 (3.5-12.0)	2.42 (0.25-3.25)	4.21	6.8	4.4	A+	
9	9	14	-	-	2.98	2.98	4.64	-	-	10.60 (3.5-12.0)	2.54 (0.25-3.25)	4.18	7.0	4.4	A+	
9	9	18	-	-	2.65	2.65	5.30	-	-	10.60 (3.5-12.0)	2.54 (0.25-3.25)	4.18	7.0	4.4	A+	
9	9	22	-	-	2.39	2.39	5.82	-	-	10.60 (3.5-12.0)	2.54 (0.25-3.25)	4.18	7.0	4.4	A+	
9	9	24	-	-	2.27	2.27	6.06	-	-	10.60 (3.5-12.0)	2.54 (0.25-3.25)	4.18	7.0	4.4	A+	
9	12	12	-	-	2.80	3.85	3.85	-	-	10.60 (3.5-12.0)	2.54 (0.25-3.25)	4.18	7.0	4.4	A+	
9	12	14	-	-	2.73	3.63	4.24	-	-	10.60 (3.5-12.0)	2.54 (0.25-3.25)	4.18	7.0	4.4	A+	
9	12	18	-	-	2.45	3.26	4.89	-	-	10.60 (3.5-12.0)	2.54 (0.25-3.25)	4.18	7.0	4.4	A+	
9	12	22	-	-	2.22	2.96	5.42	-	-	10.60 (3.5-12.0)	2.54 (0.25-3.25)	4.18	7.0	4.4	A+	
9	12	24	-	-	2.12	2.83	5.65	-	-	10.60 (3.5-12.0)	2.54 (0.25-3.25)	4.18	7.0	4.4	A+	
9	14	14	-	-	2.58	4.01	4.01	-	-	10.60 (3.5-12.0)	2.54 (0.25-3.25)	4.18	7.0	4.4	A+	
9	14	18	-	-	2.33	3.62	4.65	-	-	10.60 (3.5-12.0)	2.54 (0.25-3.25)	4.18	7.0	4.4	A+	
9	14	22	-	-	2.12	3.30	5.18	-	-	10.60 (3.5-12.0)	2.54 (0.25-3.25)	4.18	7.0	4.4	A+	
9	14	24	-	-	2.03	3.16	5.41	-	-	10.60 (3.5-12.0)	2.54 (0.25-3.25)	4.18	7.0	4.4	A+	
9	18	18	-	-	2.12	4.44	4.44	-	-	10.60 (3.5-12.0)	2.54 (0.25-3.25)	4.18	7.0	4.4	A+	
9	18	22	-	-	1.95	3.89	4.76	-	-	10.60 (3.5-12.0)	2.54 (0.25-3.25)	4.18	7.0	4.4	A+	
9	18	24	-	-	1.87	3.74	4.99	-	-	10.60 (3.5-12.0)	2.54 (0.25-3.25)	4.18	7.0	4.4	A+	
12	12	12	-	-	3.53	3.53	3.53	-	-	10.60 (3.5-12.0)	2.54 (0.25-3.25)	4.18	7.0	4.4	A+	
12	12	14	-	-	3.35	3.35	3.90	-	-	10.60 (3.5-12.0)	2.54 (0.25-3.25)	4.18	7.0	4.4	A+	
12	12	18	-	-	3.03	3.03	4.54	-	-	10.60 (3.5-12.0)	2.54 (0.25-3.25)	4.18	7.0	4.4	A+	
12	12	22	-	-	2.77	2.77	5.06	-	-	10.60 (3.5-12.0)	2.54 (0.25-3.25)	4.18	7.0	4.4	A+	
12	12	24	-	-	2.65	2.65	5.30	-	-	10.60 (3.5-12.0)	2.54 (0.25-3.25)	4.18	7.0	4.4	A+	
12	14	14	-	-	3.18	3.71	3.71	-	-	10.60 (3.5-12.0)	2.54 (0.25-3.25)	4.18	7.0	4.4	A+	
12	14	18	-	-	2.89	3.37	4.34	-	-	10.60 (3.5-12.0)	2.54 (0.25-3.25)	4.18	7.0	4.4	A+	
12	14	22	-	-	2.65	3.09	4.86	-	-	10.60 (3.5-12.0)	2.54 (0.25-3.25)	4.18	7.0	4.4	A+	
12	14	24	-	-	2.54	2.97	5.09	-	-	10.60 (3.5-12.0)	2.54 (0.25-3.25)	4.18	7.0	4.4	A+	
12	18	18	-	-	2.64	3.98	3.98	-	-	10.60 (3.5-12.0)	2.54 (0.25-3.25)	4.18	7.0	4.4	A+	
12	18	22	-	-	2.45	3.67	4.48	-	-	10.60 (3.5-12.0)	2.54 (0.25-3.25)	4.18	7.0	4.4	A+	
12	18	24	-	-	2.36	3.53	4.71	-	-	10.60 (3.5-12.0)	2.54 (0.25-3.25)	4.18	7.0	4.4	A+	
14	14	14	-	-	3.53	3.53	3.53	-	-	10.60 (3.5-12.0)	2.54 (0.25-3.25)	4.18	7.0	4.4	A+	
14	14	18	-	-	3.23	3.23	4.14	-	-	10.60 (3.5-12.0)	2.54 (0.25-3.25)	4.18	7.0	4.4	A+	
14	14	22	-	-	2.97	2.97	4.66	-	-	10.60 (3.5-12.0)	2.54 (0.25-3.25)	4.18	7.0	4.4	A+	
14	14	24	-	-	2.85	2.85	4.90	-	-	10.60 (3.5-12.0)	2.54 (0.25-3.25)	4.18	7.0	4.4	A+	
14	18	18	-	-	2.96	3.82	3.82	-	-	10.60 (3.5-12.0)	2.54 (0.25-3.25)	4.18	7.0	4.4	A+	
18	18	18	-	-	3.53	3.53	3.53	-	-	10.60 (3.5-12.0)	2.54 (0.25-3.25)	4.18	7.0	4.4	A+	
7	7	7	7	-	2.40	2.40	2.40	2.40	-	9.60 (3.5-11.2)	2.17 (0.25-2.87)	4.42	6.5	4.6	A++	
7	7	7	9	-	2.40	2.40	2.40	3.00	-	10.20 (3.5-12.0)	2.33 (0.25-3.25)	4.37	6.8	4.5	A+	
7	7	7	12	-	2.25	2.25	2.25	3.85	-	10.60 (3.5-12.0)	2.44 (0.25-3.25)	4.34	7.0	4.5	A+	
7	7	7	14	-	2.12	2.12	2.12	4.24	-	10.60 (3.5-12.0)	2.44 (0.25-3.25)	4.34	7.0	4.5	A+	
7	7	7	18	-	1.90	1.90	1.90	4.90	-	10.60 (3.5-12.0)	2.44 (0.25-3.25)	4.34	7.0	4.5	A+	
7	7	7	22	-	1.73	1.73	1.73	5.41	-	10.60 (3.5-12.0)	2.44 (0.25-3.25)	4.34	7.0	4.5	A+	
7	7	7	24	-	1.65	1.65	1.65	5.65	-	10.60 (3.5-12.0)	2.44 (0.25-3.25)	4.34	7.0	4.5	A+	
7	7	9	9	-	2.32	2.32	2.98	2.98	-	10.60 (3.5-12.0)	2.40 (0.25-3.25)	4.34	7.0	4.5	A+	
7	7	9	12	-	2.12	2.12	2.73	3.63	-	10.60 (3.5-12.0)	2.44 (0.25-3.25)	4.34	7.0	4.5	A+	
7	7	9	14	-	2.01	2.01	2.57	4.01	-	10.60 (3.						

6-unit Multi-split Combination Table-Cooling

6-unit Multi-split cooling

AOYG45LBLA6	Combination of Indoor Units						Cooling Operation				Input Power (Min. - Max.)	EER		
							Cooling Capacity							
							Unit 1	Unit 2	Unit 3	Unit 4			Unit 5	Unit 6
kW						kW				kW				
2-unit connection	12	24	-	-	-	-	3.50	7.00	-	-	-	10.5 (3.5-11.5)	3.06 (0.8-3.32)	3.43
	14	24	-	-	-	-	4.00	7.00	-	-	-	11.0 (3.5-12.1)	3.28 (0.8-3.70)	3.35
	18	18	-	-	-	-	5.00	5.00	-	-	-	10.0 (3.5-11.5)	2.92 (0.8-3.32)	3.42
	18	24	-	-	-	-	5.00	7.00	-	-	-	12.0 (3.5-13.4)	3.75 (0.8-4.46)	3.20
	24	24	-	-	-	-	6.25	6.25	-	-	-	12.5 (3.5-14.0)	4.01 (0.8-4.84)	3.12
	7	7	24	-	-	-	2.00	2.00	7.00	-	-	3.19 (0.8-3.70)	3.19 (0.8-3.70)	3.45
	7	9	18	-	-	-	2.00	2.50	5.00	-	-	9.5 (3.5-10.8)	2.55 (0.8-2.93)	3.73
	7	9	24	-	-	-	2.00	2.50	7.00	-	-	11.5 (3.5-12.7)	3.41 (0.8-4.08)	3.37
	7	12	18	-	-	-	2.00	3.50	5.00	-	-	10.5 (3.5-11.8)	3.02 (0.8-3.51)	3.48
	7	12	24	-	-	-	2.00	3.50	6.90	-	-	12.4 (3.5-13.7)	3.82 (0.8-4.65)	3.25
	7	14	14	-	-	-	2.00	4.00	4.00	-	-	10.0 (3.5-11.1)	2.81 (0.8-3.13)	3.56
	7	14	18	-	-	-	2.00	4.00	5.00	-	-	11.0 (3.5-12.4)	3.23 (0.8-3.89)	3.41
7	14	24	-	-	-	1.94	3.89	6.67	-	-	12.5 (3.5-14.0)	3.89 (0.8-4.84)	3.21	
7	18	18	-	-	-	2.00	5.00	5.00	-	-	12.0 (3.5-13.7)	3.69 (0.8-4.65)	3.25	
7	18	24	-	-	-	1.79	4.59	6.12	-	-	12.5 (3.5-14.0)	3.87 (0.8-4.84)	3.23	
7	24	24	-	-	-	1.60	5.45	5.45	-	-	12.5 (3.5-14.0)	3.83 (0.8-4.84)	3.26	
9	9	18	-	-	-	2.50	2.50	5.00	-	-	10.0 (3.5-11.5)	2.84 (0.8-3.32)	3.52	
9	9	24	-	-	-	2.50	2.50	7.00	-	-	12.0 (3.5-13.4)	3.65 (0.8-4.46)	3.29	
9	12	14	-	-	-	2.50	3.50	4.00	-	-	10.0 (3.5-11.1)	2.81 (0.8-3.13)	3.56	
9	12	18	-	-	-	2.50	3.50	5.00	-	-	11.0 (3.5-12.4)	3.23 (0.8-3.89)	3.41	
9	12	24	-	-	-	2.50	3.33	6.67	-	-	12.5 (3.5-14.0)	3.89 (0.8-4.84)	3.21	
9	14	14	-	-	-	2.50	4.00	4.00	-	-	10.5 (3.5-11.8)	3.02 (0.8-3.51)	3.48	
9	14	18	-	-	-	2.50	4.00	5.00	-	-	11.5 (3.5-12.7)	3.41 (0.8-4.08)	3.37	
9	14	24	-	-	-	2.40	3.73	6.38	-	-	12.5 (3.5-14.0)	3.88 (0.8-4.84)	3.22	
9	18	18	-	-	-	2.50	5.00	5.00	-	-	12.5 (3.5-14.0)	3.89 (0.8-4.84)	3.21	
9	18	24	-	-	-	2.21	4.41	5.88	-	-	12.5 (3.5-14.0)	3.86 (0.8-4.84)	3.24	
9	24	24	-	-	-	1.98	5.26	5.26	-	-	12.5 (3.5-14.0)	3.82 (0.8-4.84)	3.27	
12	12	12	-	-	-	3.50	3.50	3.50	-	-	10.5 (3.5-11.5)	2.98 (0.8-3.32)	3.52	
12	12	14	-	-	-	3.50	3.50	4.00	-	-	11.0 (3.5-12.1)	3.19 (0.8-3.70)	3.45	
12	12	18	-	-	-	3.50	3.50	5.00	-	-	12.0 (3.5-13.4)	3.65 (0.8-4.46)	3.29	
12	12	24	-	-	-	3.13	3.13	6.24	-	-	12.5 (3.5-14.0)	3.87 (0.8-4.84)	3.23	
12	14	14	-	-	-	3.50	4.00	4.00	-	-	11.5 (3.5-12.7)	3.41 (0.8-4.08)	3.37	
12	14	18	-	-	-	3.50	4.00	5.00	-	-	12.5 (3.5-14.0)	3.89 (0.8-4.84)	3.21	
12	14	24	-	-	-	3.00	3.50	6.00	-	-	12.5 (3.5-14.0)	3.86 (0.8-4.84)	3.24	
12	18	18	-	-	-	3.12	4.69	4.69	-	-	12.5 (3.5-14.0)	3.87 (0.8-4.84)	3.23	
12	18	24	-	-	-	2.78	4.17	5.55	-	-	12.5 (3.5-14.0)	3.85 (0.8-4.84)	3.25	
12	24	24	-	-	-	2.50	5.00	5.00	-	-	12.5 (3.5-14.0)	3.81 (0.8-4.84)	3.28	
14	14	14	-	-	-	4.00	4.00	4.00	-	-	12.0 (3.5-13.4)	3.65 (0.8-4.46)	3.29	
14	14	18	-	-	-	3.80	3.80	4.90	-	-	12.5 (3.5-14.0)	3.88 (0.8-4.84)	3.22	
14	14	24	-	-	-	3.37	3.37	5.76	-	-	12.5 (3.5-14.0)	3.85 (0.8-4.84)	3.25	
14	18	18	-	-	-	4.50	4.50	4.50	-	-	12.5 (3.5-14.0)	3.85 (0.8-4.84)	3.24	
14	18	24	-	-	-	3.13	4.02	5.35	-	-	12.5 (3.5-14.0)	3.83 (0.8-4.84)	3.26	
14	24	24	-	-	-	2.82	4.84	4.84	-	-	12.5 (3.5-14.0)	3.80 (0.8-4.84)	3.29	
18	18	18	-	-	-	4.17	4.17	4.17	-	-	12.5 (3.5-14.0)	3.85 (0.8-4.84)	3.25	
18	18	24	-	-	-	3.75	3.75	5.00	-	-	12.5 (3.5-14.0)	3.81 (0.8-4.84)	3.28	
7	7	7	14	-	-	2.00	2.00	2.00	4.00	-	10.0 (3.5-11.1)	2.50 (0.8-3.13)	4.00	
7	7	7	18	-	-	2.00	2.00	2.00	5.00	-	11.0 (3.5-12.4)	3.06 (0.8-3.89)	3.59	
7	7	7	24	-	-	1.94	1.94	1.94	6.68	-	12.5 (3.5-14.0)	3.77 (0.8-4.84)	3.32	
7	7	9	12	-	-	2.00	2.00	2.50	3.50	-	10.0 (3.5-11.1)	2.50 (0.8-3.13)	4.00	
7	7	9	18	-	-	2.00	2.00	2.50	4.00	-	10.5 (3.5-11.8)	2.79 (0.8-3.51)	3.76	
7	7	9	24	-	-	2.00	2.00	2.50	5.00	-	11.5 (3.5-12.7)	3.33 (0.8-4.27)	3.45	
7	7	9	18	18	-	1.86	1.86	2.39	6.39	-	12.5 (3.5-14.0)	3.75 (0.8-4.84)	3.33	
7	7	12	12	-	-	2.00	2.00	3.50	3.50	-	11.0 (3.5-12.1)	3.00 (0.8-3.70)	3.67	
7	7	12	14	-	-	2.00	2.00	3.50	4.00	-	11.5 (3.5-12.7)	3.27 (0.8-4.08)	3.52	
7	7	12	18	-	-	2.00	2.00	3.50	5.00	-	12.5 (3.5-14.0)	3.78 (0.8-4.84)	3.31	
7	7	12	24	-	-	1.75	1.75	3.00	6.00	-	12.5 (3.5-14.0)	3.74 (0.8-4.84)	3.34	
7	7	14	14	-	-	2.00	2.00	4.00	4.00	-	12.0 (3.5-13.4)	3.51 (0.8-4.46)	3.42	
7	7	14	18	-	-	1.90	1.90	3.80	4.90	-	12.5 (3.5-14.0)	3.77 (0.8-4.84)	3.32	
7	7	14	24	-	-	1.68	1.68	3.37	5.77	-	12.5 (3.5-14.0)	3.73 (0.8-4.84)	3.35	
7	7	18	18	-	-	1.75	1.75	4.50	4.50	-	12.5 (3.5-14.0)	3.74 (0.8-4.84)	3.34	
7	7	18	24	-	-	1.56	1.56	4.02	5.36	-	12.5 (3.5-14.0)	3.70 (0.8-4.84)	3.38	
7	7	24	24	-	-	1.41	1.41	4.84	4.84	-	12.5 (3.5-14.0)	3.67 (0.8-4.84)	3.41	
7	9	9	9	-	-	2.00	2.50	2.50	2.50	-	9.5 (3.5-10.8)	2.31 (0.8-2.93)	4.11	
7	9	9	12	-	-	2.00	2.50	2.50	3.50	-	10.5 (3.5-11.8)	2.79 (0.8-3.51)	3.76	
7	9	9	18	-	-	2.00	2.50	2.50	4.00	-	11.0 (3.5-12.4)	3.06 (0.8-3.89)	3.59	
7	9	9	24	-	-	2.00	2.50	2.50	5.00	-	12.0 (3.5-13.4)	3.57 (0.8-4.65)	3.36	
7	9	9	18	18	-	1.79	2.30	2.30	6.11	-	12.5 (3.5-14.0)	3.74 (0.8-4.84)	3.34	
7	9	12	12	-	-	2.00	2.50	3.50	3.50	-	11.5 (3.5-12.7)	3.27 (0.8-4.08)	3.52	
7	9	12	14	-	-	2.00	2.50	3.50	4.00	-	12.0 (3.5-13.4)	3.50 (0.8-4.46)	3.42	
7	9	12	18	-	-	1.90	2.45	3.26	4.89	-	12.5 (3.5-14.0)	3.77 (0.8-4.84)	3.32	
7	9	12	24	-	-	1.68	2.16	2.88	5.78	-	12.5 (3.5-14.0)	3.73 (0.8-4.84)	3.35	
7	9	14	14	-	-	2.00	2.50	4.00	4.00	-	12.5 (3.5-14.0)	3.78 (0.8-4.84)	3.31	
7	9	14	18	-	-	1.82	2.34	3.65	4.69	-	12.5 (3.5-14.0)	3.75 (0.8-4.84)	3.33	
7	9	14	24	-	-	1.62	2.08	3.24	5.56	-	12.5 (3.5-14.0)	3.71 (0.8-4.84)	3.37	
7	9	18	18	-	-	1.68	2.16	4.33	4.33	-	12.5 (3.5-14.0)	3.73 (0.8-4.84)	3.35	
7	9	18	24	-	-	1.51	1.94	3.88	5.17	-	12.5 (3.5-14.0)	3.69 (0.8-4.84)	3.39	
7	12	12	12	-	-	3.50	3.50	3.50	3.50	-	12.0 (3.5-13.4)	3.69 (0.8-4.65)	3.36	
7	12	12	14	-	-	3.33	3.33	3.90	3.90	-	12.5 (3.5-14.0)	3.77 (0.8-4.84)	3.32	
7	12	12	18	-	-	1.79	3.06	3.06	4.59	-	12.5 (3.5-14.0)	3.74 (0.8-4.84)	3.34	
7	12	12	24	-	-	1.59	2.73	2.73	5.45	-	12.5 (3.5-14.0)	3.71 (0.8-4.84)	3.37	
7	12	14	14	-	-	1.87	3.19	3.72	4.72	-	12.5 (3.5-14.0)	3.75 (0.8-4.84)	3.33	
7	12	14	18	-	-	1.72	2.94	3.43	4.41	-	12.5 (3.5-14.0)	3.73 (0.8-4.84)	3.35	
7	12	14	24	-	-	1.54	2.63	3.07	5.26	-	12.5 (3.5-14.0)	3.70 (0.8-4.84)	3.38	
7	12	18	18	-	-	1.59	2.73	4.09	4.09	-	12.5 (3.5-14.0)	3.71 (0.8-4.84)	3.37	
7	12	18	24	-	-	1.43	2.46	3.69	4.92	-	12.5 (3.5-14.0)	3.68 (0.8-4.84)	3.40	
7	14	14	14	-	-	1.79	3.57	3.57	3.57	-	12.5 (3.5-14.0)	3.74 (0.8-4.84)	3.34	
7	14	14	18	-	-	1.65	3.30	3.30	4.25	-	12.5 (3.5-14.0)	3.72 (0.8-4.84)	3.36	
7	14	14	24	-	-	1.48	2.97	2.97	5.08	-	12.5 (3.5-14.0)	3.69 (0.8-4.84)	3.39	
7	14	18	18	-	-	1.53	3.07	3.95	3.95	-	12.5 (3.5-14.0)	3.70 (0.8-4.84)	3.38	
7	18	18	18	-	-	1.43	3.69	3.69	3.69	-	12.5 (3.5-14.0)	3.68 (0.8-4.84)	3.40	
9	9	9	9	-	-	2.50	2.50	2.50	2.50	-	10.0 (3.5-11.5)	2.59 (0.8-3.32)	3.86	
9	9	9	12	-	-	2.50	2.50	2.50	3.50	-	11.0 (3.5-12.4)	3.06 (0.8-3.89)	3.59	
9	9	9	18	-	-	2.50	2.50	2.50	4.00	-	11.5 (3.5-12.7)	3.33 (0.8-4.27)	3.45	
9	9	9	24	-	-	2.50	2.50	2.50	5.00	-	12.0 (3.5-13.4)	3.51 (0.8-4.46)	3.42	
9	9	9	18	18	-	2.21	2.21	2.21	5.87	-	12.5 (3.5-14.0)	3.51 (0.8-4.46)	3.42	
9	9	12	12	-	-	2.50	2.50	3.50	3.50	-	11.0 (3.5-12.4)	3.		

8-unit Multi-split Combination Table-Cooling/Heating

8-unit Multi-split cooling

AOYG45LBT8	Combination of Indoor Units		Cooling Operation										Input power
			Cooling Capacity										
			Unit 1	Unit 2	Unit 3	Unit 4	Unit 5	Unit 6	Unit 7	Unit 8	Total		
	7	9	1.79	2.30	2.30	2.30	2.30	4.59	-	-	15.57	5.88	
	7	9	1.93	2.49	2.49	2.49	2.49	3.32	-	-	15.22	5.90	
	7	9	2.05	2.64	2.64	2.64	2.64	2.64	-	-	15.25	5.79	
	7	7	1.77	1.77	3.04	3.04	3.04	3.04	-	-	15.69	5.87	
	7	7	1.79	1.79	2.30	3.07	3.07	3.57	-	-	15.57	5.88	
	7	7	1.82	1.82	2.34	3.12	3.12	3.12	-	-	15.34	5.89	
	7	7	1.80	1.80	2.32	2.32	3.60	3.60	-	-	15.45	5.89	
	7	7	1.77	1.77	2.28	2.28	3.04	4.55	-	-	15.69	5.87	
	7	7	1.83	1.83	2.36	2.36	3.15	3.67	-	-	15.21	5.90	
	7	7	1.92	1.92	2.47	2.47	3.30	3.30	-	-	15.38	5.90	
	7	7	1.82	1.82	2.34	2.34	2.34	4.67	-	-	15.33	5.89	
	7	7	1.93	1.93	2.49	2.49	3.87	-	-	15.21	5.90		
	7	7	1.96	1.96	2.53	2.53	2.53	3.37	-	-	14.88	5.90	
	7	7	2.05	2.05	2.64	2.64	2.64	2.64	-	-	14.66	5.50	
	7	7	1.79	1.79	1.79	3.07	3.57	-	-	15.57	5.88		
	7	7	1.82	1.82	1.82	3.12	3.12	3.64	-	-	15.33	5.89	
	7	7	1.91	1.91	1.91	3.28	3.28	3.28	-	-	15.55	5.90	
	7	7	1.77	1.77	1.77	2.28	3.54	4.55	-	-	15.68	5.87	
	7	7	1.84	1.84	1.84	2.36	3.67	3.67	-	-	15.21	5.90	
	7	7	1.80	1.80	1.80	2.32	3.09	4.63	-	-	15.45	5.89	
	7	7	1.92	1.92	1.92	2.47	3.30	3.84	-	-	15.38	5.90	
	7	7	1.95	1.95	1.95	2.51	3.35	3.35	-	-	15.05	5.90	
	7	7	1.91	1.91	1.91	2.46	2.46	4.90	-	-	15.54	5.90	
	7	7	1.96	1.96	1.96	2.53	2.53	3.93	-	-	14.87	5.90	
	7	7	2.05	2.05	2.05	2.64	2.64	3.52	-	-	14.95	5.65	
	7	7	2.05	2.05	2.05	2.64	2.64	2.64	-	-	14.07	5.20	
	7	7	1.80	1.80	1.80	1.80	3.60	4.63	-	-	15.45	5.89	
	7	7	1.92	1.92	1.92	1.92	3.84	3.84	-	-	15.37	5.90	
	7	7	1.84	1.84	1.84	1.84	3.15	4.72	-	-	15.21	5.90	
	7	7	1.95	1.95	1.95	1.95	3.35	3.90	-	-	15.04	5.90	
	7	7	2.05	2.05	2.05	2.05	3.52	3.52	-	-	15.24	5.79	
	7	7	1.79	1.79	1.79	2.30	6.12	-	-	15.57	5.88		
	7	7	1.93	1.93	1.93	1.93	2.49	4.97	-	-	15.21	5.90	
	7	7	2.05	2.05	2.05	2.05	2.64	4.10	-	-	14.94	5.65	
	7	7	2.05	2.05	2.05	2.05	2.64	3.52	-	-	14.36	5.35	
	7	7	2.05	2.05	2.05	2.05	2.64	2.64	-	-	13.48	4.89	
	7	7	1.82	1.82	1.82	1.82	6.24	-	-	15.33	5.89		
	7	7	1.96	1.96	1.96	1.96	1.96	5.05	-	-	14.87	5.90	
	7	7	2.05	2.05	2.05	2.05	4.10	-	-	14.35	5.35		
	7	7	2.05	2.05	2.05	2.05	2.05	3.52	-	-	13.77	5.05	
	7	7	2.05	2.05	2.05	2.05	2.05	2.64	-	-	12.89	4.57	
	7	7	2.05	2.05	2.05	2.05	2.05	2.05	-	-	12.30	4.24	
	7	9	1.78	2.30	2.30	2.30	2.30	2.30	2.30	-	15.57	5.88	
	7	9	1.77	1.77	2.28	2.28	2.28	3.04	-	-	15.69	5.87	
	7	9	1.82	1.82	2.34	2.34	2.34	2.34	-	-	15.34	5.89	
	7	9	1.77	1.77	2.28	2.28	2.28	3.54	-	-	15.69	5.87	
	7	9	1.80	1.80	1.80	2.32	2.32	2.32	3.09	-	15.45	5.89	
	7	9	1.91	1.91	1.91	2.46	2.46	2.46	2.46	-	15.55	5.90	
	7	9	1.79	1.79	1.79	1.79	2.30	3.07	3.07	-	15.57	5.88	
	7	9	1.80	1.80	1.80	1.80	2.32	3.60	3.60	-	15.45	5.89	
	7	9	1.83	1.83	1.83	1.83	2.36	3.15	-	-	15.21	5.90	
	7	9	1.93	1.93	1.93	2.49	2.49	2.49	-	-	15.21	5.90	
	7	9	1.79	1.79	1.79	1.79	3.07	3.57	-	-	15.57	5.88	
	7	9	1.82	1.82	1.82	1.82	3.12	3.12	-	-	15.33	5.89	
	7	9	1.77	1.77	1.77	1.77	2.28	4.55	-	-	15.68	5.87	
	7	9	1.84	1.84	1.84	1.84	2.36	3.67	-	-	15.21	5.90	
	7	9	1.92	1.92	1.92	1.92	2.47	3.30	-	-	15.38	5.90	
	7	9	1.96	1.96	1.96	1.96	2.53	2.53	-	-	14.87	5.90	
	7	9	1.80	1.80	1.80	1.80	1.80	4.63	-	-	15.45	5.89	
	7	9	1.92	1.92	1.92	1.92	1.92	3.84	-	-	15.37	5.90	
	7	9	1.95	1.95	1.95	1.95	1.95	3.35	-	-	15.04	5.90	
	7	9	2.05	2.05	2.05	2.05	2.05	2.64	-	-	14.36	5.35	
	7	9	2.05	2.05	2.05	2.05	2.05	2.05	-	-	14.35	5.35	
	7	9	1.77	1.77	1.77	1.77	2.28	2.28	2.28	2.28	15.69	5.87	
	7	9	1.80	1.80	1.80	1.80	1.80	1.80	2.32	2.28	15.45	5.89	
	7	9	1.79	1.79	1.79	1.79	1.79	1.79	3.07	2.32	15.57	5.88	
	7	9	1.84	1.84	1.84	1.84	1.84	1.84	2.36	1.84	15.21	5.90	
	7	9	1.92	1.92	1.92	1.92	1.92	1.92	1.92	1.92	15.37	5.90	

Notes: •Cooling capacity is determined based on 27°CDB/19°CWB (indoor temperature) and 35°CDB (outdoor temperature).
 •Pipe Length: 5 m (Outdoor unit to Branch box), 3 m (Branch box to Indoor unit)
 •Height difference: 0 m (Outdoor unit to Indoor unit)
 •The specifications in the table are for reference only. These values are calculated at standard conditions.
 Refer to "Model Selection" in the D&T manual to select your model.

8-unit Multi-split heating

AOYG45LBT8	Combination of Indoor Units		Heating Operation										Input power
			Heating Capacity										
			Unit 1	Unit 2	Unit 3	Unit 4	Unit 5	Unit 6	Unit 7	Unit 8	Total		
	24	24	7.91	7.91	-	-	-	-	-	-	15.82	5.07	
	18	24	5.86	7.91	-	-	-	-	-	-	13.77	4.21	
	18	18	5.32	5.32	7.18	-	-	-	-	-	17.82	5.98	
	18	18	5.79	5.79	5.79	-	-	-	-	-	17.38	5.43	
	14	24	4.26	7.02	7.02	-	-	-	-	-	18.31	5.98	
	14	18	4.59	5.61	7.57	-	-	-	-	-	17.77	5.70	
	14	18	4.78	5.84	5.84	-	-	-	-	-	16.46	5.11	
	14	14	4.75	4.75	7.82	-	-	-	-	-	17.32	5.23	
	14	14	4.80	4.80	5.86	-	-	-	-	-	15.46	4.75	
	14*	14*	4.80	4.80	4.80	-	-	-	-	-	14.40	4.21	
	12	24	3.58	7.15	7.15	-	-	-	-	-	17.89	5.98	
	12	18	3.84	5.68	7.67	-	-	-	-	-	17.19	5.43	
	12	18	3.96	5.86	5.86	-	-	-	-	-	15.68	5.07	
	12	14	3.94	4.78	7.87	-	-	-	-	-	16.59	5.11	
	12	14	3.96	4.80	5.86	-	-	-	-	-	14.62	4.46	
	12*	14*	3.96	4.80	7.81	-	-	-	-	-	13.56	4.00	
	12	12	3.96	3.96	7.91	-	-	-	-	-	15.83	5.07	
	12	12	3.96	3.96	5.86	-	-	-	-	-	13.78	4.21	
	9	24	2.85	7.54	7.54	-	-	-	-	-	17.93	5.87	
	9	18	2.97	5.83	7.87	-	-	-	-	-	16.67	5.16	
	9	18	2.99	5.86	5.86	-	-	-	-	-	14.71	4.60	
	9	14	2.99	4.80	7.91	-	-	-	-	-	15.70	4.91	
	9	14	2.99	4.80	5.86	-	-	-	-	-	13.65	4.10	
	9	12	2.99	3.96	7.91	-	-	-	-	-	14.86	4.60	
	9	12	2.99	3.96	5.86	-	-	-	-	-	12.81	3.90	
	9	9	2.99	2.99	7.91	-	-	-	-	-	13.89	4.21	
	7	24	2.28	7.61	7.61	-	-	-	-	-	17.51	5.56	
	7	18	2.37	5.85	7.90	-	-	-	-	-	16.12	5.08	
	7	18	2.37	5.86	5.86	-	-	-	-	-	14.09	4.33	
	7	14	2.37	4.80	7.91	-	-	-	-	-	15.08	4.60	
	7	14	2.37	4.80	5.86	-	-	-	-	-	13.03	3.90	
	7	12	2.37	3.96	7.91	-	-	-	-	-	14.24	4.33	
	7	9	2.37	2.99	7.91	-	-	-	-	-	13.27	4.00	
	14	14	4.30	4.30	4.30	5.24	-	-	-	-	18.13	5.98	
	14	14	4.55	4.55	4.55	4.55	-	-	-	-	18.20	5.70	
	12	14	3.53	4.28	5.22	5.22	-	-	-	-	18.24	5.98	
	12	14	3.61	4.38	4.38	5.34	-	-	-	-	17.71	5.98	
	12	14	3.80	4.61	4.61	4.61	-	-	-	-	17.62	5.43	
	12	12	3.59	3.59	5.32	5.32	-	-	-	-	17.82	5.98	
	12	12	3.52	3.52	4.26	7.02	-	-	-	-	18.32	5.98	
	12	12	3.79	4.59	5.61	-	-	-	-	-	17.77	5.70	
	12	12	3.92	3.92	4.75	4.75	-	-	-	-			

8-unit Multi-split Combination Table-Heating

8-unit Multi-split heating

AOYG45LBT8	Combination of Indoor Units								Heating Operation													
									Heating Capacity								Total	Input power				
									Unit 1	Unit 2	Unit 3	Unit 4	Unit 5	Unit 6	Unit 7	Unit 8			kW	kW		
4-unit connection									kW	kW	kW	kW	kW	kW	kW	kW	kW	kW	kW	kW	kW	kW
7	7	14	18	-	-	-	-	-	2.37	2.37	4.80	4.80	-	-	-	-	-	15.40	4.75			
7	7	14	14	-	-	-	-	-	2.37	2.37	4.80	4.80	-	-	-	-	-	14.34	4.21			
7	7	12	24	-	-	-	-	-	2.36	2.36	3.94	7.87	-	-	-	-	-	16.53	5.11			
7	7	12	18	-	-	-	-	-	2.37	2.37	3.96	5.86	-	-	-	-	-	14.56	4.46			
7	7	12	14	-	-	-	-	-	2.37	2.37	3.96	4.80	-	-	-	-	-	13.50	4.00			
7	7	9	24	-	-	-	-	-	2.37	2.37	2.99	7.91	-	-	-	-	-	15.64	4.91			
7	7	9	18	-	-	-	-	-	2.37	2.37	2.99	5.86	-	-	-	-	-	13.59	4.10			
7	7	7	24	-	-	-	-	-	2.37	2.37	2.37	7.81	-	-	-	-	-	15.02	4.60			
7	7	7	18	-	-	-	-	-	2.37	2.37	2.37	5.86	-	-	-	-	-	12.97	3.90			
12	12	12	12	14	-	-	-	-	3.51	3.51	3.51	3.51	4.26	-	-	-	-	18.32	5.98			
12	12	12	12	12	-	-	-	-	3.58	3.58	3.58	3.58	3.58	-	-	-	-	17.90	5.98			
9	12	12	14	14	-	-	-	-	2.66	3.52	3.52	4.27	4.27	-	-	-	-	18.26	5.98			
9	12	12	14	14	-	-	-	-	2.71	3.59	3.59	4.35	4.35	-	-	-	-	17.84	5.98			
9	12	12	12	12	-	-	-	-	2.85	3.77	3.77	3.77	3.77	-	-	-	-	17.95	5.87			
9	9	14	14	14	-	-	-	-	2.67	2.67	4.28	4.28	4.28	-	-	-	-	18.19	5.98			
9	9	12	14	18	-	-	-	-	2.66	2.66	3.52	4.26	5.21	-	-	-	-	18.30	5.98			
9	9	12	14	14	-	-	-	-	2.72	3.60	4.37	4.37	4.37	-	-	-	-	17.77	5.98			
9	9	12	12	18	-	-	-	-	2.71	2.71	3.58	3.58	5.30	-	-	-	-	17.88	5.98			
9	9	12	12	14	-	-	-	-	2.86	2.86	3.78	4.58	4.58	-	-	-	-	17.86	5.70			
9	9	12	12	12	-	-	-	-	2.89	2.89	3.83	3.83	3.83	-	-	-	-	17.28	5.43			
9	9	9	14	18	-	-	-	-	2.71	2.71	4.36	5.32	5.32	-	-	-	-	17.82	5.98			
9	9	9	14	14	-	-	-	-	2.86	2.86	2.86	4.59	4.59	-	-	-	-	17.77	5.56			
9	9	9	12	18	-	-	-	-	2.85	2.85	2.85	3.78	5.59	-	-	-	-	17.92	5.87			
9	9	9	12	14	-	-	-	-	2.90	2.90	2.90	3.84	4.65	-	-	-	-	17.19	5.32			
9	9	9	12	12	-	-	-	-	2.97	2.97	3.93	3.93	3.93	-	-	-	-	16.78	5.16			
9	9	9	9	24	-	-	-	-	2.70	2.70	2.70	2.70	7.14	-	-	-	-	17.94	5.98			
9	9	9	9	18	-	-	-	-	2.89	2.89	2.89	2.89	5.67	-	-	-	-	17.25	5.43			
9	9	9	9	14	-	-	-	-	2.97	2.97	2.97	2.97	4.77	-	-	-	-	16.67	5.11			
9	9	9	9	12	-	-	-	-	2.99	2.99	2.99	2.99	3.96	-	-	-	-	15.92	5.07			
9	9	9	9	9	-	-	-	-	2.99	2.99	2.99	2.99	2.99	-	-	-	-	14.95	4.60			
7	12	14	14	14	-	-	-	-	2.10	3.51	4.25	4.25	4.25	-	-	-	-	18.37	5.98			
7	12	12	14	14	-	-	-	-	2.14	3.57	3.57	4.33	4.33	-	-	-	-	17.95	5.98			
7	12	12	12	18	-	-	-	-	2.13	3.56	3.56	3.56	5.26	-	-	-	-	18.06	5.98			
7	12	12	12	14	-	-	-	-	2.25	3.76	3.76	3.76	4.56	-	-	-	-	18.10	5.87			
7	12	12	12	12	-	-	-	-	2.28	3.81	3.81	3.81	4.61	-	-	-	-	17.52	5.56			
7	9	14	14	18	-	-	-	-	2.09	2.64	4.24	4.24	5.18	-	-	-	-	18.40	5.98			
7	9	14	14	14	-	-	-	-	2.14	2.71	4.34	4.34	4.34	-	-	-	-	17.88	5.98			
7	9	12	14	18	-	-	-	-	2.13	2.69	3.57	4.32	5.28	-	-	-	-	17.99	5.98			
7	9	12	14	14	-	-	-	-	2.26	2.85	3.77	4.57	5.47	-	-	-	-	18.01	5.70			
7	9	12	12	18	-	-	-	-	2.25	2.84	3.76	3.76	5.56	-	-	-	-	18.16	5.98			
7	9	12	12	14	-	-	-	-	2.28	2.88	3.82	3.82	4.63	-	-	-	-	17.43	5.43			
7	9	12	12	12	-	-	-	-	2.35	2.96	3.92	3.92	3.92	-	-	-	-	17.09	5.23			
7	9	9	18	18	-	-	-	-	2.13	2.69	4.29	5.27	5.27	-	-	-	-	18.04	5.98			
7	9	9	14	18	-	-	-	-	2.25	2.84	3.66	4.57	4.57	-	-	-	-	18.07	5.87			
7	9	9	14	14	-	-	-	-	2.29	2.89	2.89	4.64	4.64	-	-	-	-	17.34	5.32			
7	9	9	12	24	-	-	-	-	2.12	2.68	3.55	7.08	7.08	-	-	-	-	18.11	5.98			
7	9	9	12	18	-	-	-	-	2.28	2.88	2.88	3.81	5.64	-	-	-	-	17.49	5.56			
7	9	9	12	14	-	-	-	-	2.35	2.97	3.93	4.76	4.76	-	-	-	-	16.97	5.16			
7	9	9	12	12	-	-	-	-	2.37	2.98	2.98	3.95	3.95	-	-	-	-	16.24	5.08			
7	9	9	9	24	-	-	-	-	2.17	2.74	2.74	2.74	7.24	-	-	-	-	17.63	5.98			
7	9	9	9	18	-	-	-	-	2.35	2.96	2.96	2.96	5.81	-	-	-	-	17.05	5.23			
7	9	9	9	14	-	-	-	-	2.37	2.99	2.99	2.99	4.79	-	-	-	-	16.12	5.07			
7	9	9	9	12	-	-	-	-	2.37	2.99	2.99	2.99	3.96	-	-	-	-	15.30	4.75			
7	9	9	9	9	-	-	-	-	2.37	2.99	2.99	2.99	2.99	-	-	-	-	14.33	4.33			
7	7	14	14	18	-	-	-	-	2.12	2.12	4.30	5.25	5.25	-	-	-	-	18.10	5.98			
7	7	14	14	14	-	-	-	-	2.25	2.25	4.55	4.55	4.55	-	-	-	-	18.16	5.70			
7	7	12	18	18	-	-	-	-	2.11	2.11	3.53	5.23	5.23	-	-	-	-	18.21	5.98			
7	7	12	14	18	-	-	-	-	2.16	2.16	3.62	4.38	5.35	-	-	-	-	17.68	5.98			
7	7	12	14	14	-	-	-	-	2.28	2.28	3.80	4.61	4.61	-	-	-	-	17.58	5.43			
7	7	12	12	24	-	-	-	-	2.11	2.11	3.52	3.52	7.03	-	-	-	-	18.29	5.98			
7	7	12	12	14	-	-	-	-	2.35	2.35	3.92	3.92	4.75	-	-	-	-	17.28	5.23			
7	7	12	12	12	-	-	-	-	2.36	2.36	3.94	3.94	4.75	-	-	-	-	16.54	5.11			
7	7	9	18	18	-	-	-	-	2.16	2.16	2.72	5.34	5.34	-	-	-	-	17.73	5.98			
7	7	9	14	24	-	-	-	-	2.11	2.11	2.67	4.28	7.05	-	-	-	-	18.22	5.98			
7	7	9	14	18	-	-	-	-	2.27	2.27	2.87	4.61	5.62	-	-	-	-	17.64	5.56			
7	7	9	14	14	-	-	-	-	2.35	2.35	2.96	4.75	4.75	-	-	-	-	17.16	5.16			
7	7	9	12	24	-	-	-	-	2.15	2.15	2.72	3.60	7.18	-	-	-	-	17.80	5.98			
7	7	9	12	18	-	-	-	-	2.34	2.34	2.96	3.92	5.80	-	-	-	-	17.36	5.32			
7	7	9	12	14	-	-	-	-	2.36	2.36	2.98	3.95	4.78	-	-	-	-	16.43	5.08			
7	7	9	12	12	-	-	-	-	2.37	2.37	2.37	3.96	3.96	-	-	-	-	15.65	4.91			
7	7	9	9	24	-	-	-	-	2.27	2.27	2.86	3.56	3.56	-	-	-	-	17.81	5.70			
7	7	9	9	18	-	-	-	-	2.36	2.36	2.98	2.98	5.83	-	-	-	-	16.51	5.11			
7	7	9	9	14	-	-	-	-	2.37	2.37	2.99	2.99	4.80	-	-	-	-	15.52	4.75			
7	7	9	9	12	-	-	-	-	2.37	2.37	2.99	2.99	3.96	-	-	-	-	14.68	4.46			
7	7	9	9	9	-	-	-	-	2.37	2.37	2.99	2.99	2.99	-	-	-	-	13.71	4.10			
7	7	7	18	18	-	-	-	-	2.26	2.26	2.26	5.58	5.58	-	-	-	-	17.95	5.87			
7	7	7	14	24	-	-	-	-	2.14	2.14	2.14	4.34	7.15	-	-	-	-	17.91	5.98			
7	7	7	14	18	-	-	-	-	2.30	2.30	2.30	4.65	5.68	-	-	-	-	17.22	5.32			
7	7	7	14	14	-	-	-	-	2.36	2.36	2.36	4.77	4.77	-	-	-	-	16.62	5.08			
7	7	7	12	24	-	-	-	-	2.25	2.25	2.25	3.77	7.52	-	-	-	-	18.05	5.87			
7	7	7	12	18	-	-	-	-	2.35	2.35	2.35	3.93	5.82	-	-	-	-	16.81	5.16			
7	7	7	12	14	-	-	-	-	2.37	2.37	2.37	3.96	4.80	-	-	-	-	15.87	4.91			
7	7	7	12	12	-	-	-	-	2.37	2.37	2.37	3										

Feature Summary

Type	Wall-mounted type								Cassette		Cassette						Duct			Floor		Floor/Ceiling	Ceiling	
	Designer Series		Standard Series		Designer Series	Standard Series		Compact 4-way Flow Grid type Series	Compact 4-way Flow Series	4-way Flow Series	Mini (With drain pump)		Slim (With drain pump)		Medium Static Pressure									
Series	ASYG 07/09/12/14 KGTB	ASYG 07/09/12/14 KETA, ASYG 07/09/12/14 KETA-B	ASYG 07/09/12/14 KMCC	ASYG 18/22/24 KMTB	ASYG 07/09/12/14 LUCA	ASYG 07/09/12/14 LMCE	ASYG18LFCA, ASYG24LFCC	AUXG 07/09/12/14/18/22/24 KVLA	AUYG 07/09/12/14/18/22/24 LVLB, AUYG 22/24LVLA	AUYG 07/09/12/14/18/22/24 LRLA, AUYG 36/45LRLA	ARXG 07/09/12/14/18 KSLAP	ARYG 07/09/12/14/18 LSLAP	ARXG 07/09/12/14/18 KLLAP	ARYG 07/09/12/14/18 LLTB	ARXG22KMLB, ARXG24KMLA	ARYG 22/24/36/45 LMLA, ARYG 30/36LMLE	AGYG 09/12/14 KVCA	AGYG 09/12/14 LVCA	ABYG 14/22/24 LVTA, ABYG18LVTB	ABYG 18/22KRTA	ABYG 30/36LRTE, ABYG 36/45LRTA			
Refrigerant	R32		R32	R32	R32	R410A		R410A	R410A		R32	R410A	R32	R410A	R32	R410A	R32	R410A	R410A	R410A	R410A	R410A		
Energy-saving Features	Save Human sensor	●																						
	Economy mode	●	●	●	●	●	●	●	●	●	●	●	●	●	●	●	●	●	●	●	●			
	Setting temperature range limitation	○	○	○	○	○	○	○	○	○	○	○	○	○	○	○	○	○	○	○	○			
	Set temperature auto return	○	○	○	○	○	○	●	○	○	●	●	○	○	○	○	○	○	○	○	○			
Features for Comfort	Power diffuser						●	●																
	Powerful mode	●	●	●	●	●	●										●							
	10°C Heat	●	●	●	●	●	●	●	●	○	○	○	○	○	○	○	●	●	●	○	●			
	Low noise mode	●	●	●	●	●	●									○ (45) (36LMLA)	●			○	○ (45/54)(36LRTA)			
	Auto changeover	●	●	●	●	●	●	●	●	●	●	●	●	●	●	●	●	●	●	●	●			
	UP/DOWN swing louver	●	●	●	●	●	●	●	●	●	○	○	○	○			●	●	●	●	●			
	Double swing automatic				●		●													●	●			
	Automatic fan speed	●	●	●	●	●	●	●	●	●	●	●	●	●	●	●	●	●	●	●	●			
	Auto restart	●	●	●	●	●	●	●	●	●	●	●	●	●	●	●	●	●	●	●	●			
	Connectable fresh air duct								○	●					●	●				●	●			
	Fresh air intake								○	○				○	○	○	○				○	○		
	Connectable distributing duct														●	●								
	Convenience Features	Auto-off timer	○	○	○	○	○	○	○	○	○	○	○	○	○	○	○	○	○	○	○	○		
		Sleep timer	●	●	●	●	●	●	●	●	●	○	○	○	○	○	○	○	○	○	○	○		
Program timer		●	●	●	●	●	●	●	●	●	○	○	○	○	○	○	○	○	○	○	○			
Weekly timer		●	●	○	●	●	●	●	●	●							●			●	●			
Weekly & Temperature setback timer		○	○	○	○	○	○	○	○	○	●			●	●	●		○	○		○			
Filter sign		●	●	●	●	●	●	●	●	●	●	●	●	●	●	●	●	●	●	●	●	●		
External error output		○	○	○	○	○	○	○					○	○			○			○	○			
External ON/OFF input		○	○	○	○	○	○	○	○	○	○	○	○	○	○	○	○	○	○	○	○			
Wireless LAN control		○	○	○	○	○	○	○	○	○	○	○	○	○	○	○	○	○	○	○	○			
Clean Features		Ion deodorization filter	○	○	○	●	●	●	●									●	●					
	Apple-catechin filter	○	○	○	●	●	●	●									●	●						
	Long-life filter														○	○	●	●						
	Washable panel				●	●	●																	
Installation	Silver Ion Filter	○	○	○	○	○	○	○	○	○	○	○	○	○	○	○	○	○	○	○	○			
	Drain pump as standard							●	●	●	●	●	●	●	○					○	○			
	Blue fin						● (30)		● (45/54)						● (45)						● (45)			

○ : Optional function

Light Commercial & Commercial, Residential VRF

AIRSTAGE™ VRF systems provide air conditioning solutions that meet the requirements of a diverse range of buildings.

AIRSTAGE™ VRF systems provide air conditioning solutions for large residences as well as large commercial buildings.

V-002 AIRSTAGE™ J Series Overview
V-004 AIRSTAGE™ V Series Overview
V-006 VRF Outdoor Units Lineup
V-008 Features

VRF Outdoor Units



AIRSTAGE™ J Series Heat Pump for Small-Capacity Type

V-022 AIRSTAGE™ J-IVL
V-028 AIRSTAGE™ J-IV
V-032 AIRSTAGE™ J-IVS



AIRSTAGE™ V Series Heat Recovery Modular Type

V-036 AIRSTAGE™ VR-IV

Heat Pump Modular Type

V-046 AIRSTAGE™ V-III
V-052 AIRSTAGE™ V-III Tropical

VRF INDOOR UNITS

V-060 VRF Indoor Units Lineup
V-062 VRF Indoor Units

AIRSTAGE™

VRF

Light Commercial
& Commercial,
Residential

AIRSTAGE™ J Series Overview

Fujitsu General provides air conditioning systems for a wide range of applications, from residences, small offices, hotels, to large retailers.



Maximum 18 HP Heat Pump AIRSTAGE™ J-IVL

J-IVL is an outdoor unit with a slim design. Its flexibility in installation makes it ideal for midsize office buildings and hotels. With the newly added 14/16/18 HP models, up to 42 indoor units* are connectable, making them ideal for hospitals and educational facilities with many rooms.

*: 18 HP model

Slim Outdoor Unit

Although the new 14/16/18 HP models support slightly higher capacities, they have a slim depth of just 480 mm. This means they can be installed even in tight spaces.

Small room application

The optimum heat exchanger structure allows up to 30-42 indoor units to be connected to an outdoor unit, easily accommodating a number of small rooms

Class-leading Low Operating Sound

The top-class low operating noise makes it ideal for use in densely populated areas.

Maximum 6 HP Heat Pump AIRSTAGE™ J-IV

J-IV is connectable with up to 13 indoor units, making it suitable for commercial facilities housing a number of small stores.

High energy efficiency

Heat pump inverter control achieves efficient cooling and heating operation for any combination of indoor units.

Flexible system configuration for small and midsize buildings

The space saving design and long pipe connection enable flexible installation on the roof or balcony of a small or midsize building. Multiple indoor units of various capacities and types can be connected.



Maximum 6 HP Heat Pump, Compact Design AIRSTAGE™ J-IVS

The 998 mm compact design does not obstruct the view even when installed underneath a waist-high window, ideal for large houses and retail stores.

Spaces saving and low sound level design

Economical individual air conditioning is achieved by ALL-DC technology, large-capacity DC twin-rotary compressor, and 3-row heat exchanger, despite the compact size.

Flexible system configuration for homes, stores, and small buildings

The compact size and flexible pipe design make the J-IVS Series an ideal choice for installation in tight spaces in residences, stores, and small offices. Multiple indoor units of various capacities and types can be connected.



8-12 HP models

14/16/18 HP models

AIRSTAGE™ V Series Overview

AIRSTAGE™ V provides air conditioning solutions for large residences as well as large commercial buildings.



Maximum 48 HP Heat Recovery AIRSTAGE™ VR-IV

Smart, cutting-edge design
Extensive lineup from 10 HP to 48 HP
with the capacity ratio of indoor units connectable up to 150%.

Simultaneous cooling and heating operation using a single refrigerant system

Cooling and heating operations can be selected individually for each indoor unit to provide a comfortable room environment in each room by accommodating widely varying temperatures requirements.

Annual cooling operation

Choose the annual cooling option for rooms and other spaces that require constant temperature control throughout the year.

Accommodating changes in temperature difference

When there are large temperature differences during the day, such as with the change of seasons, the operation mode can be readily changed between heating and cooling.

Maximum 54 HP Heat Pump AIRSTAGE™ V-III

Smart, cutting-edge design
Available in a wide range of models from 8 to 54 HP in 2 HP increments with the capacity ratio of indoor units connectable up to 150%.

Excellent energy saving

The inverter heat pump model achieves high energy savings for individual cooling or heating operation by making full use of inverter technology to achieve seasonal efficiency.

High design flexibility for placement in any building

Superb design flexibility meets the diverse installation needs of high-rise buildings for air conditioners, such as a concentrated rooftop installation of outdoor units combined with individual floor installation of indoor units. This flexibility is achieved by large-capacity combination, ample connection capacity, and high static pressure design.

Easy installation and maintenance

The flexible communication method and pipe connections make installation and maintenance easy—even for large systems.

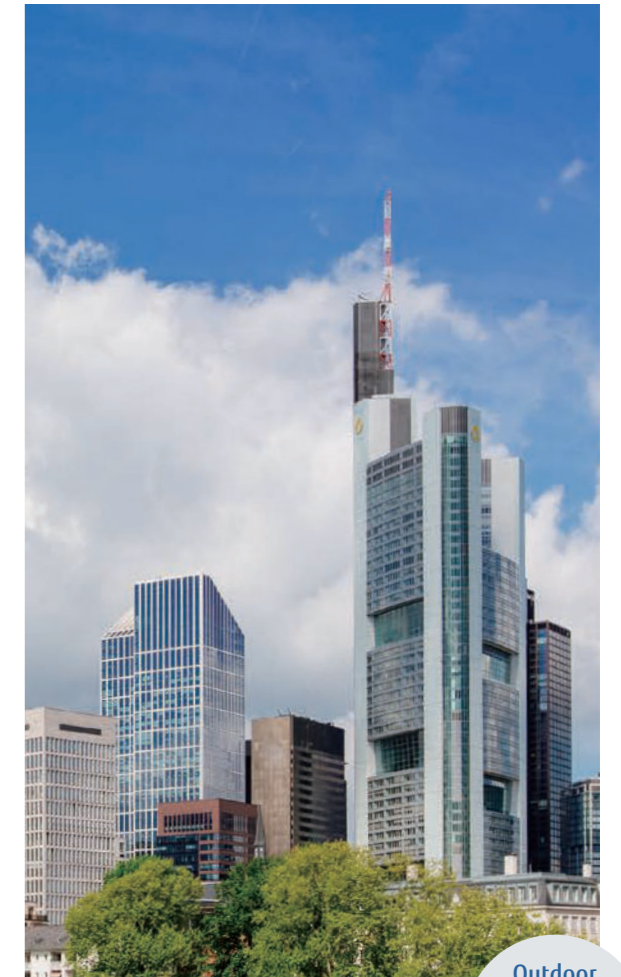

Outdoor temperature
Up to 52°C
Cooling

Maximum 54 HP Heat Pump AIRSTAGE™ V-III

Fujitsu General's Tropical VRF is designed specifically for tropical climates. Available in a wide range of models from 8 to 54 HP in 2 HP increments with the capacity ratio of indoor units connectable up to 130%.

High ambient operation design

Capable of cooling outside air temperatures of up to 52°C

Outstanding cooling capacity

Maintains high cooling capacity even at high ambient temperature

Elaborate anti-corrosion treatment

All metallic and PCB components are protected against corrosion.





Features

High-efficiency

High-efficiency is achieved significantly by the use of a DC twin-rotary compressor, inverter technology, and a large heat exchanger.



DC twin-rotary compressor

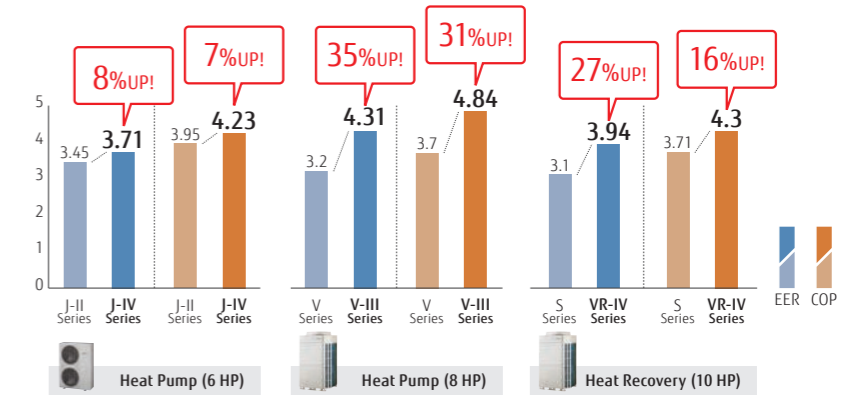

* These specifications are determined by ducted combination.

ALL DC High-efficiency design with top-class SEER/SCOP

All the VRF Series, including the J-IVL Series, have DC technology to achieve high-efficiency operation. This enhances the durability and reliability of the VRF Series.

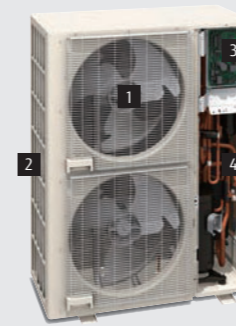

J-IVL Series

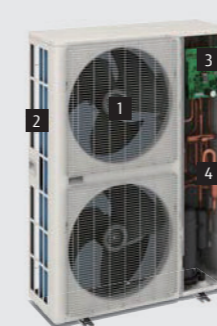



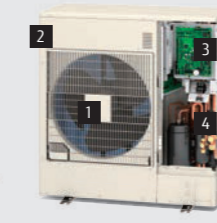

J-IV Series





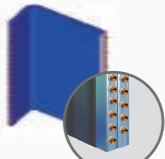

J-IVS Series



V Series

 1 DC fan motor	 3 DC inverter control
 2 Large heat exchanger	 4 Subcool heat exchanger

 1 3-phase DC fan motor	 3 Sine-wave DC inverter control
 2 Large heat exchanger	 4 Subcooling heat exchanger

Efficient control of operation

Setting temperature range limitation

Sets the minimum and maximum limits on room temperature to establish an optimum balance between energy-saving performance and a comfortable environment.

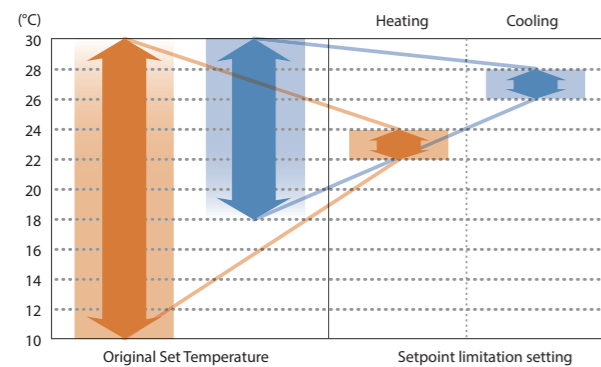

Auto-off timer

The wired remote controller is equipped with an auto-off timer function that automatically stops operation after a fixed period of time has elapsed from the start of operation to avoid wasting energy. The function also allows you to set the interval for stopping operations.

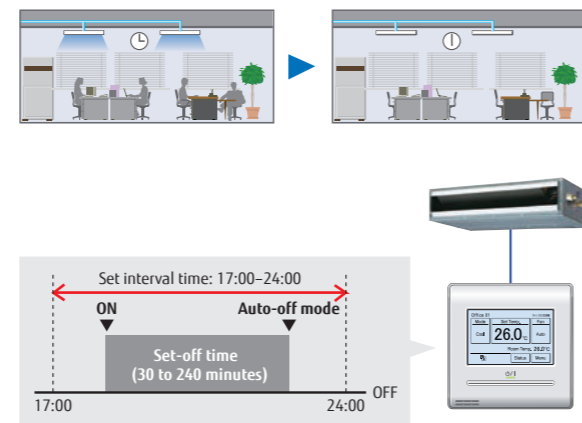

Energy-saving management

A variety of energy-saving operations can be set and managed depending on the season, climate, and time period. Excellent energy-saving operation using the system controller.

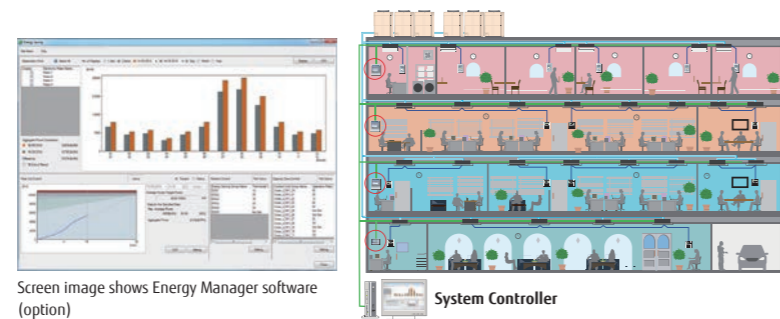

Capacity-saving mode

Operation capacity can be reduced in 5 steps from the rated capacity. This mode cuts down on peak power consumption and eases the maximum load on the unit.

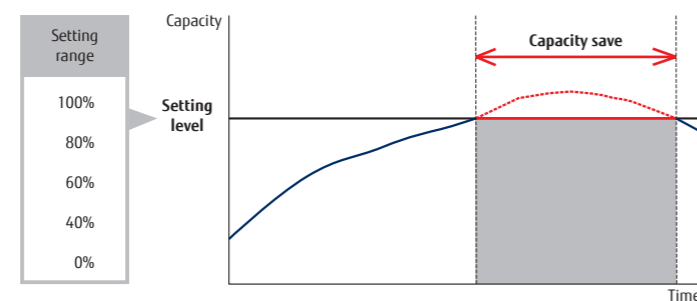

New intelligent refrigerant control

Fujitsu General is proposing outdoor units equipped with refrigerant control function. The refrigerant control operates with subtle control corresponding to the heat load of the room and offers a more comfortable environment. The refrigerant control can also provide increased energy savings.

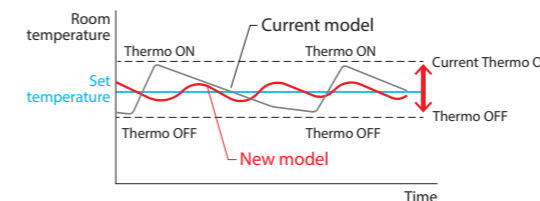

Current refrigerant control

Thermostat-ON/OFF occurs frequently. → Frequent changes in room temperature interfere with comfort. The compressor starts and stops repeatedly, wasting energy.

New refrigerant control

The thermostat is turned on and off less frequently than under current control to maintain the room temperature at the target temperature. Compared to current control, the compressor will run longer, thus saving energy.

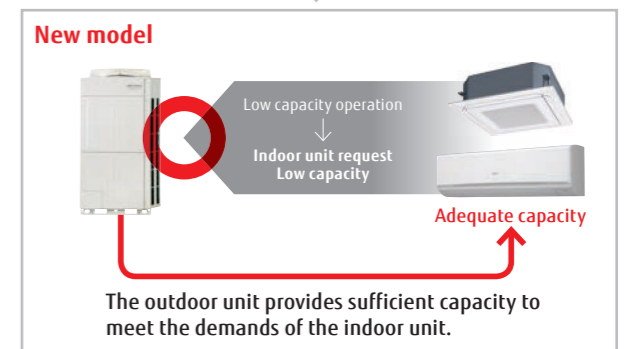
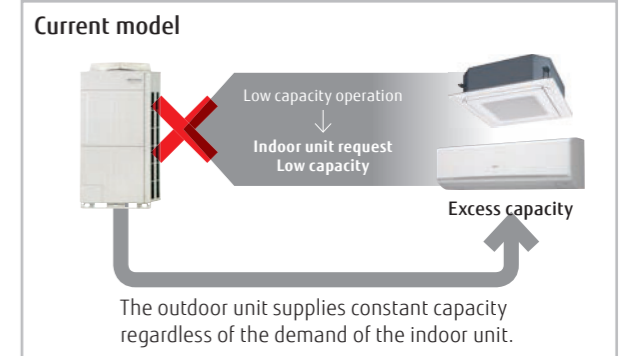

* The improvements due to the control and the actual sine wave vary depending on the combination of the indoor unit and system operating conditions.

More Comfort



Auto changeover

In Auto setting, the air conditioner switches between cooling and heating modes automatically according to the set temperature and the room temperature.

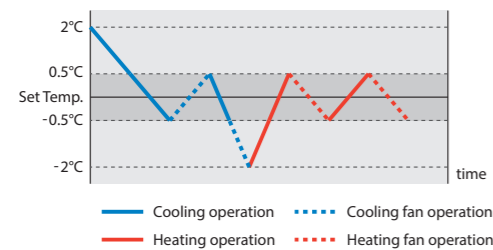

Auto changeover settings enable the indoor unit to easily switch between cooling and heating regardless of the operating mode of other indoor units. These settings can be made using a wired remote controller for a specific indoor unit. Provides a comfortable environment all year round.

Automatic cooling/heating operation for each room is possible

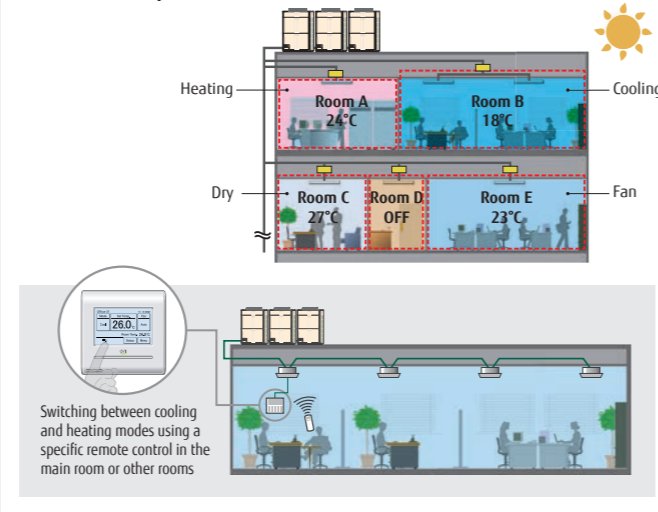

Precise control of refrigerant flow

The combination of DC inverter control and individual control of electronic expansion valves of an indoor unit enables precise and smooth control of the refrigerant flow. This means the room temperature can be set in increments of 0.5°C.

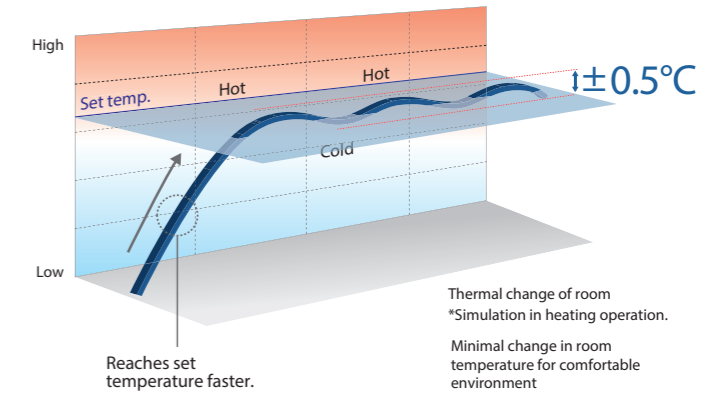

Quiet operation

Quiet operation

Two low noise modes can be switched over automatically between one in which low noise is prioritized over performance, and the other in which performance is prioritized over low noise, depending on the room temperature and outdoor temperature. This feature can be controlled by external input from the outdoor unit or a system controller.

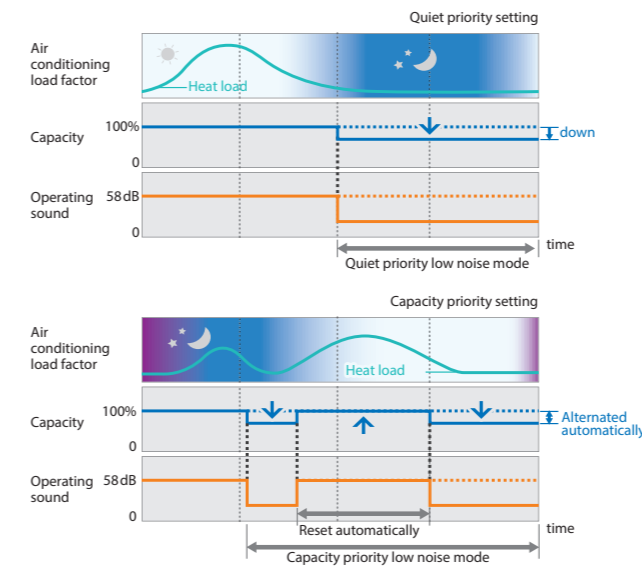

Non-stop oil recovery operation

A comfortable room condition is maintained during oil recovery mode because the product continues to operate without stopping the cooling or heating operation.

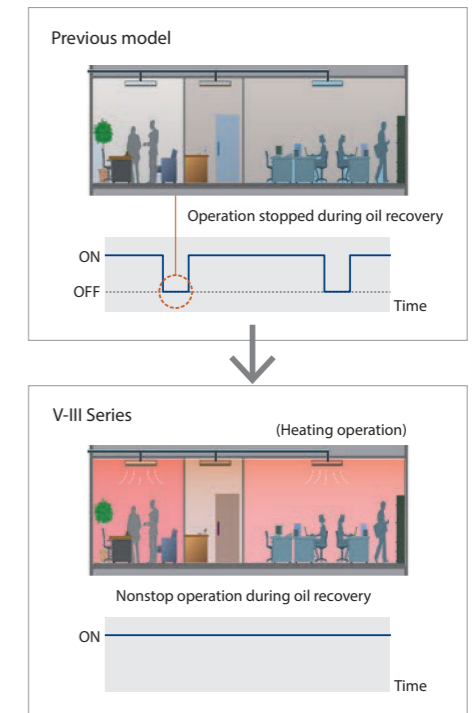

Low noise design

Small-capacity indoor units meet a variety of applications. Super low noise operations offer greater audibility comfort. In particular, the wall-mounted (external EEV) type has a noise level of only 19 dB(A) during low mode heating operation.



High Reliability

Outdoor unit rotation

The compressor starting order is rotated to equalize the cumulative running time of each unit.

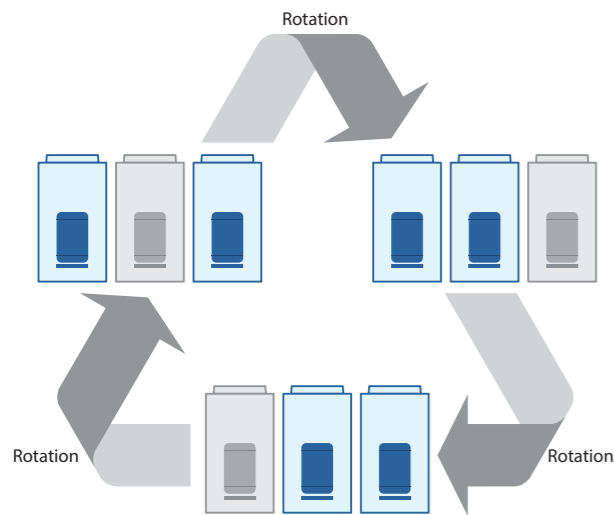

The start and stop timings are alternated among connected compressors.

Backup operation

If one compressor fails, the other compressors will initiate backup operation*.

Note: Backup operation may not be possible depending on the cause of failure.

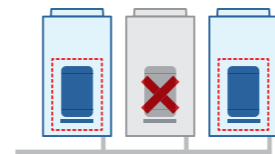

Advanced refrigerant control

Compressor control logic controls the inverter speed to balance the mass airflow rate of refrigerant in each outdoor unit.

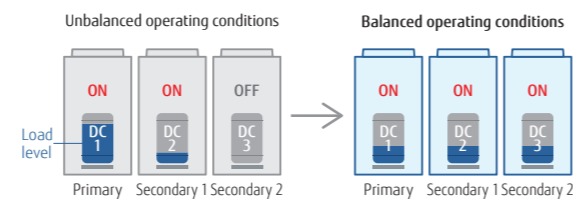

Protection against liquid flowback

The use of a large accumulator means that refrigerant that has not been completely vaporized stays inside the accumulator to ensure no liquid refrigerant is fed into the compressor.

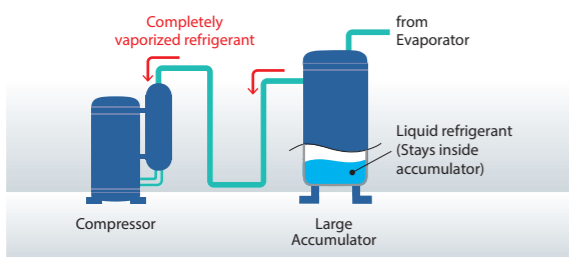

Blue fin heat exchanger

The anti-corrosion blue fin treatment is applied to the heat exchanger of the outdoor unit.

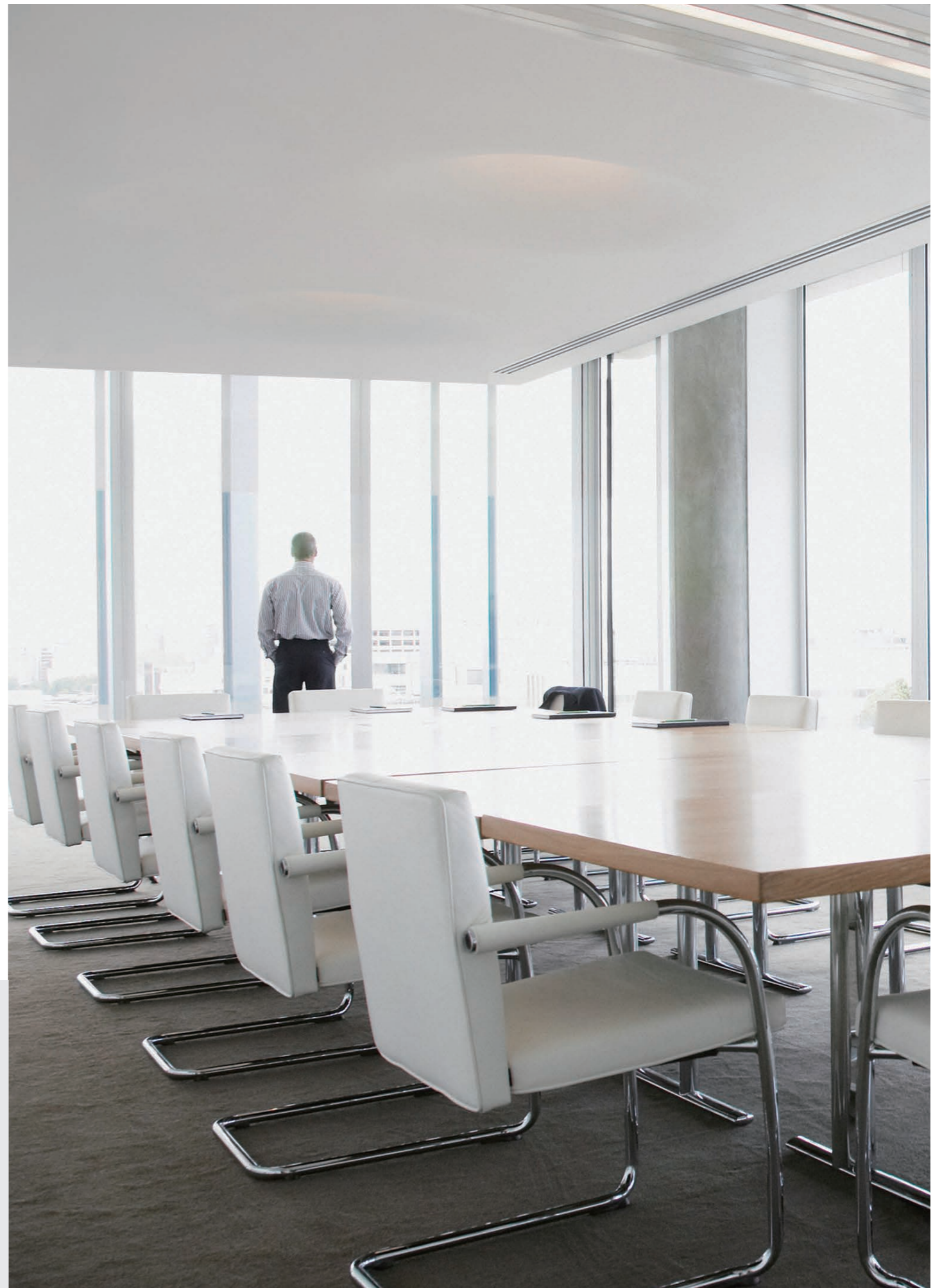
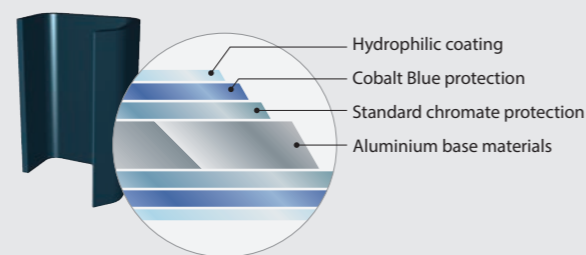

Design flexibility

Class-leading compact design

An industry-leading compact outdoor unit with optimal airflow structure design. (Up to 18 HP)



Long pipe design

Pipe design suitable for long and narrow office buildings with elevation differences and low-rise stores with long distances (AIRSTAGE™ J-IVL Series)

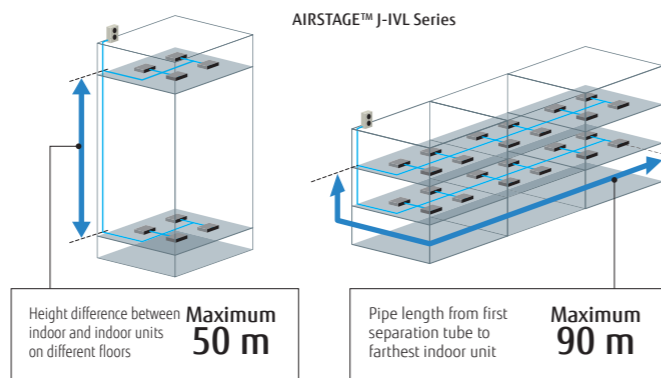

Max. allowable overall pipe length: 1,000 m

The class-leading pipe length of 1,000 m increases flexibility of installation in a wide variety of buildings.

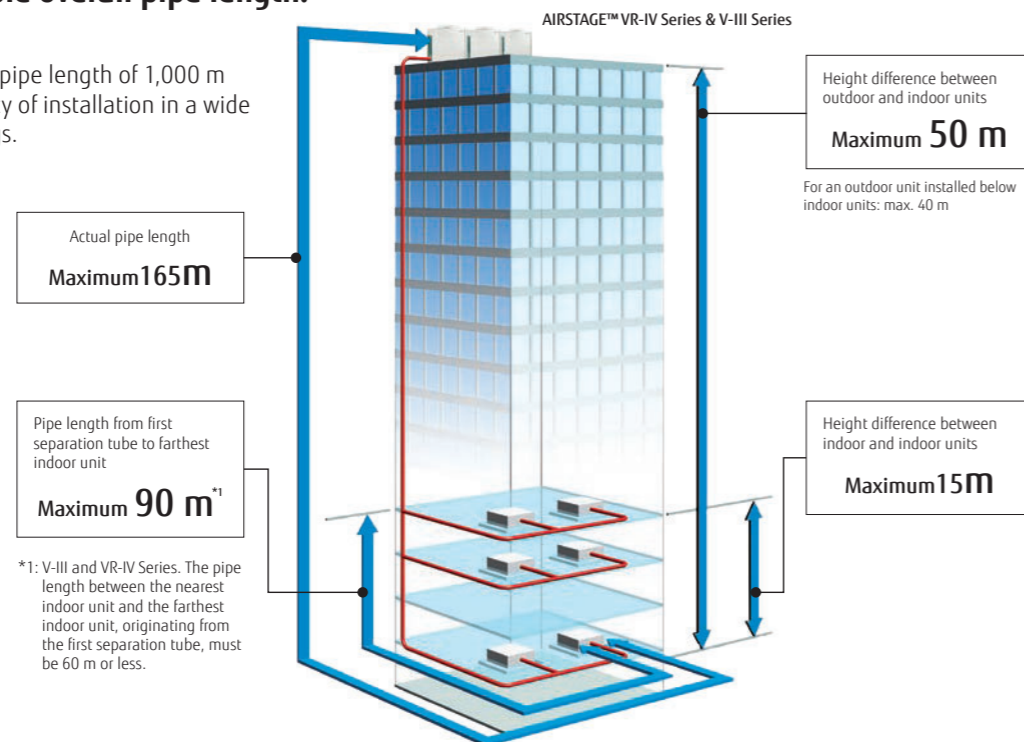

*1: V-III and VR-IV Series. The pipe length between the nearest indoor unit and the farthest indoor unit, originating from the first separation tube, must be 60 m or less.

High-capacity connection

Series	Connectable indoor unit capacity range	Connectable indoor units
AIRSTAGE™ J-IVL Series 14/16/18 HP Heat pump type	50% to 150% ^{*2}	up to 42 ^{*4}
AIRSTAGE™ J-IVL Series 8/10/12 HP Heat pump type	50% to 150% ^{*2}	up to 30 ^{*5}
AIRSTAGE™ J-IV Series Heat pump type	50% to 150% ^{*2}	up to 14 ^{*6}
AIRSTAGE™ J-IVS Series Heat pump type	50% to 130% ^{*2}	13
AIRSTAGE™ VR-IV Series Heat Recovery Modular type	25% ^{*7} to 150% ^{*2}	up to 64
AIRSTAGE™ V-III Series Heat Pump Modular type	50% to 150% ^{*3}	up to 64

*2: Conditions for the maximum capacity ratio of connectable indoor units are shown in the chart above.
 *3: The maximum capacity of the combination that includes the 18-HP outdoor unit is below 150%.
 *4: J-IVL Series 18-HP model only.
 *5: J-IVL Series 12-HP model only.
 *6: J-IV Series 6-HP model only.
 *7: For modular type, 25% to 49.9% operation in the entire system is available. (By one unit operation)

Designed for low refrigerant charge

The optimal design of the indoor and outdoor units reduces the amount of refrigerant required and can be easily installed in a room as small as 15 m².



Various optional parts

- Fresh air intake kit to bring in fresh air
- Comfortable temperature control with a remote sensor
- DX kit links ventilation equipment and air handling units.



Low ambient operation

Our refrigeration cycle technology enables cooling operation even at -15°C.



Wide operating temperature range

All outdoor units have a wide operating temperature range and can operate in extreme temperature conditions.

*8: When multiple outdoor units are connected, their operating temperature range is from -5°C to 46°C in cooling.
 *9: The operating range is -15°C to 46°C only for systems with all indoor units rated at 5.6 kW or more.

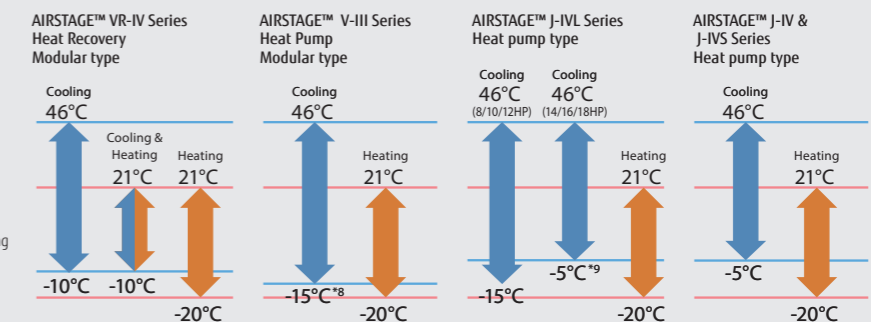

Easy Installation



Simplified wiring work

The communication wiring can be installed seamlessly among indoor, outdoor, and RB units, which makes the installation of the wiring system easier.

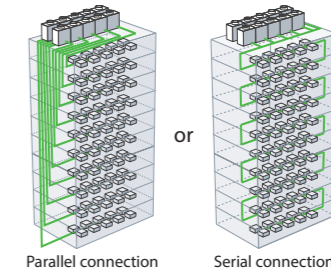

Maximum wiring length:
3,600 m

Note: The automatic address setting is not available on a serially connected multiple refrigerant system.

Vacuum mode function for easy evacuation

The vacuum mode function enables all expansion valves of an indoor unit to be opened fully, allowing for easier evacuation of air inside pipe lines and indoor units.

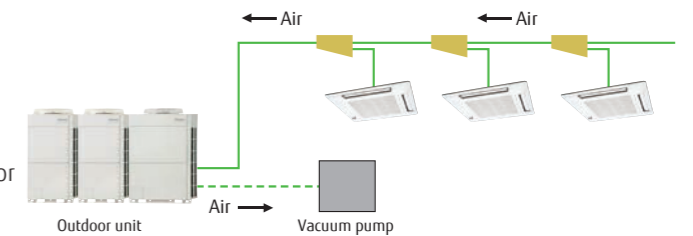

Automatic address setting

Addresses of connected indoor units, RB units, and Signal amplifier can all be set automatically from the PCB in the outdoor unit.

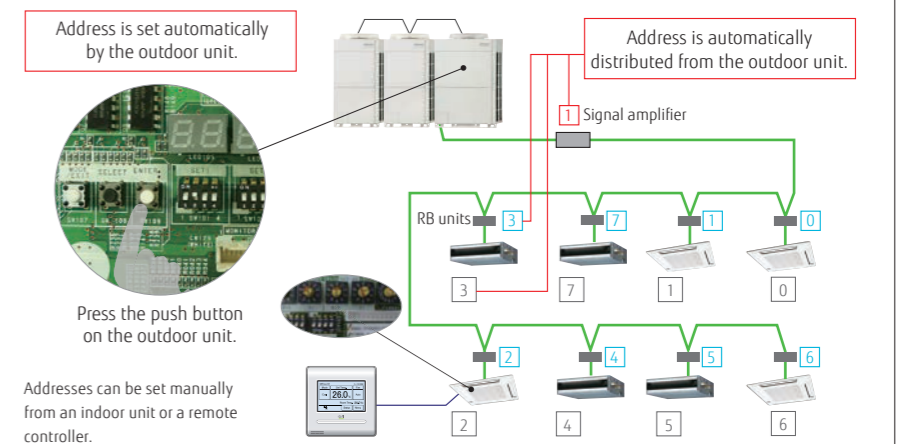

Easily transported

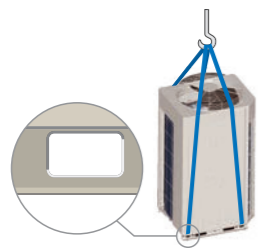

A lifting strap can be hooked onto an outdoor unit
Design of outdoor unit allows for lifting straps to be used

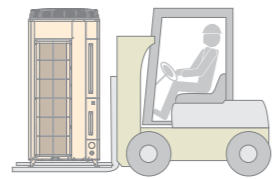

Transportable by forklift
The outdoor unit can be lifted and transported by forklift.

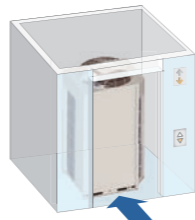

Fits into a small elevator.

Easy access

The removable L-shaped front panel provides more room for installation and service work. Multiple installations can be performed easily and efficiently even in tight spaces.

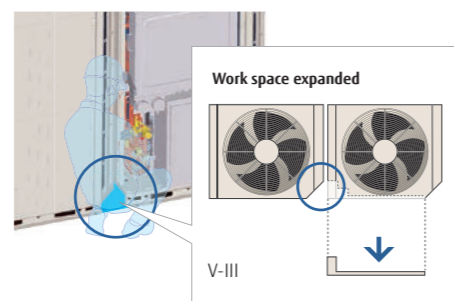

Front access reduces installation intervals

Flexible pipe connection

Piping and wiring can be accessed from the front, left, right, and bottom.

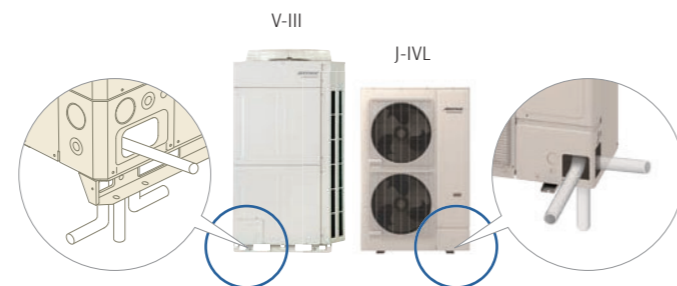

Easy commissioning with Service Tool

The Service Tool checks the refrigerant temperature and pressure, and the operating status of the electronic expansion valves, making it easy to determine if the units are connected properly.



Easy service and maintenance

Designed for easy maintenance

A 7-segment indicator lamp panel provides detailed information on the function setting status, refrigerant temperature and pressure, compressor operation time, and other factors, facilitating self-diagnosis for each unit.

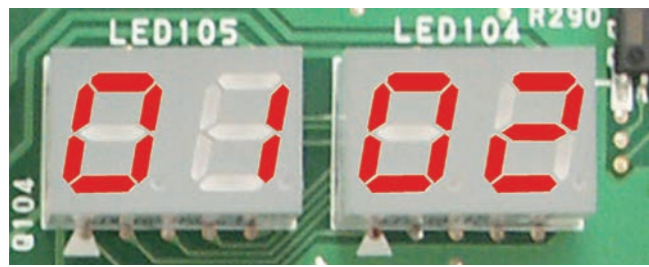

Easy-to-read 7-segment indicator lamp

Shows the following detailed operation and error status without need of any special tools.

Error status can be checked on an outdoor unit's display

- System operation mode
- Discharge temperature and pressure
- Compressor operation status
- Address, type, and number of outdoor unit

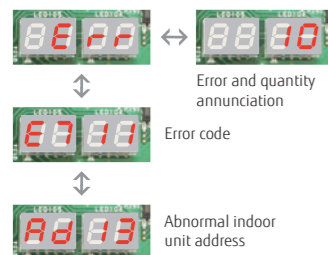

- Error status can easily be checked on an outdoor unit's display.

Movable PCB panel

Enables easier access behind the PCB for maintenance work.

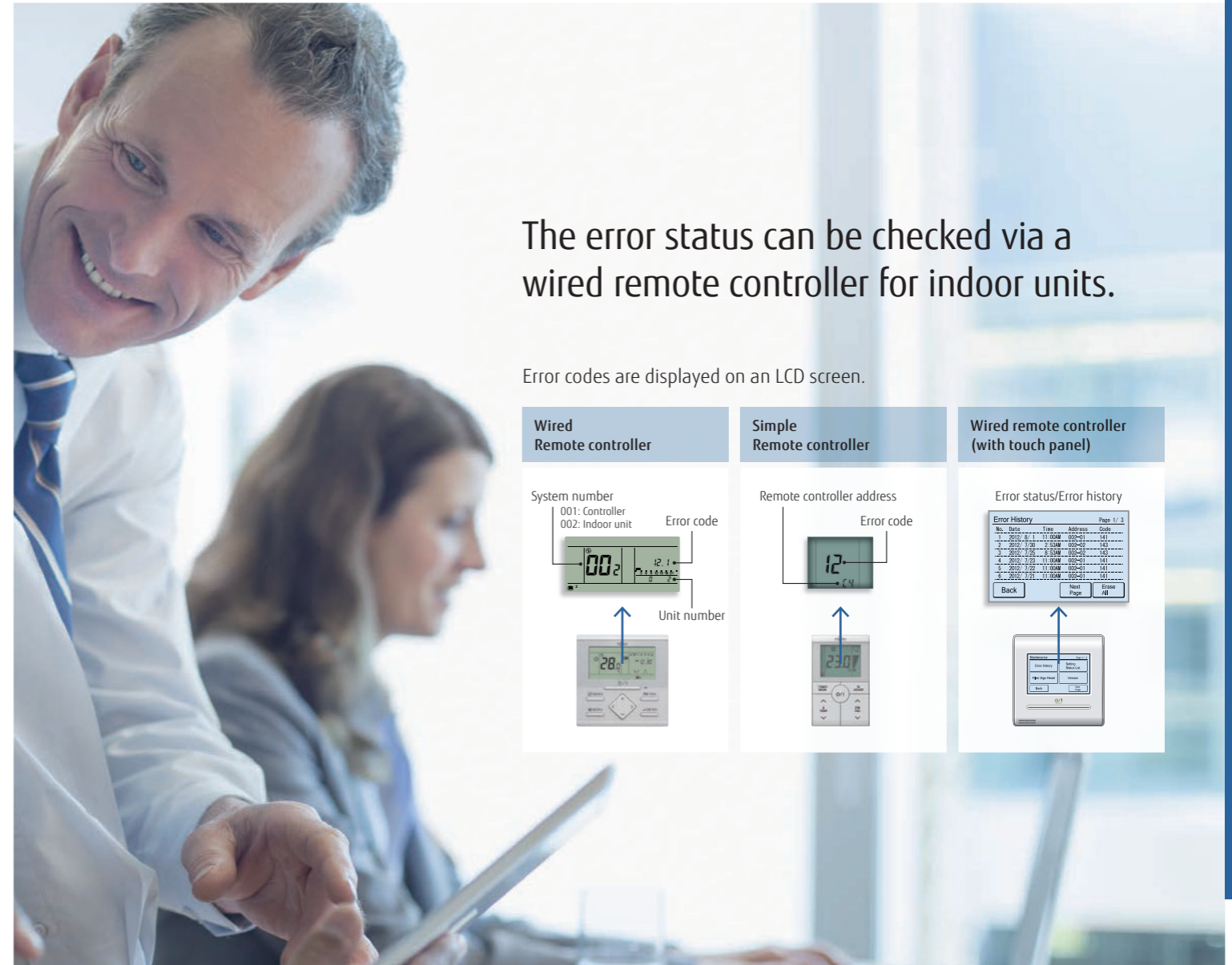
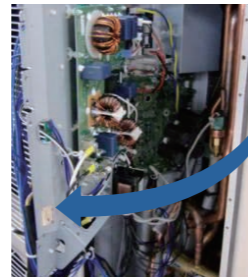

The error status can be checked via a wired remote controller for indoor units.

Error codes are displayed on an LCD screen.

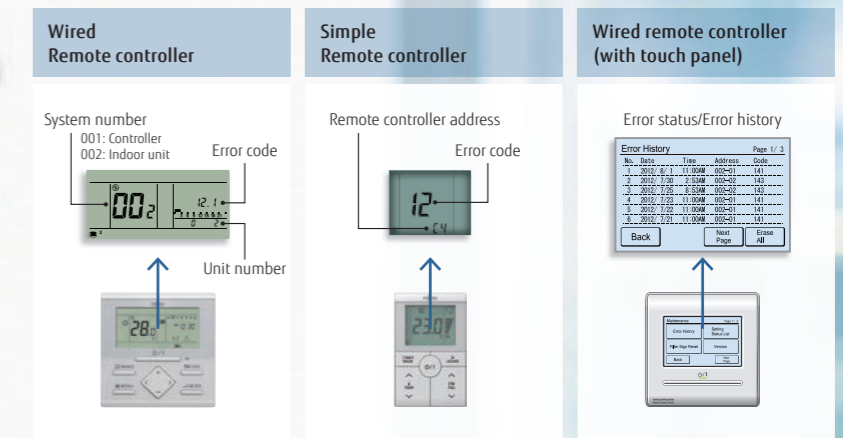

Error diagnosis by Service tool

Connection to Service tool

- A detailed operation status and recent error history can be checked and analyzed using Service tool.
- The last 5 minutes of operation status can be recorded continuously.

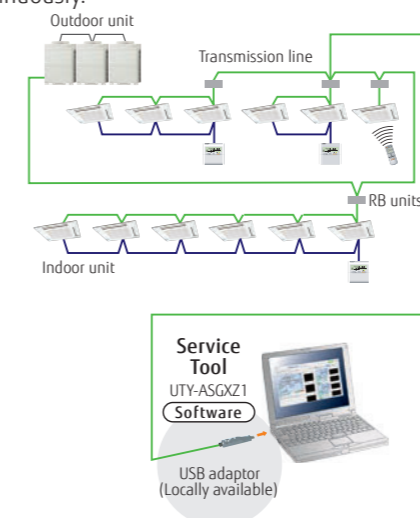

Remote monitoring

The Web Monitoring system enables the monitoring of the system's operation status at any time via the internet to ensure trouble-free operation. The operating VRF network system in the building can be monitored real time over the internet.

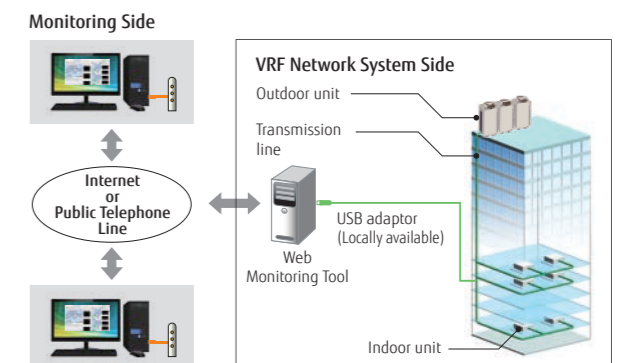

Heat Pump

for Small-capacity type



System configuration example

- Suitable for air conditioning small and medium-size buildings. One refrigerant system is used for each outdoor unit.
- Multiple indoor units are connected with separation tubes and headers.

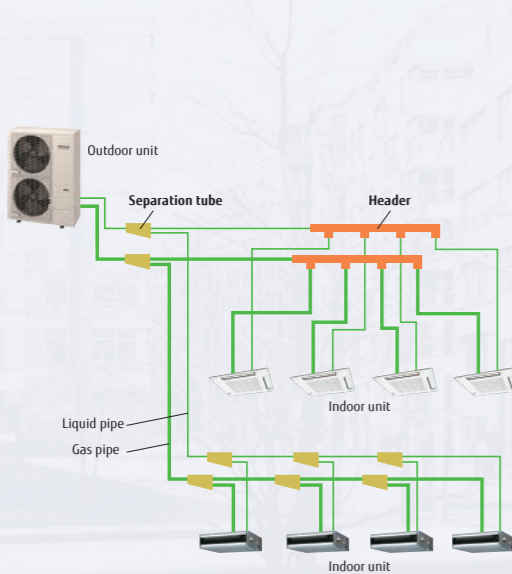

FUJITSU GENERAL (Euro) GmbH participates in the ECP program for VRF. Check ongoing validity of certificate: www.eurovent-certification.com

New intelligent refrigerant control

Fujitsu General is proposing outdoor units equipped with refrigerant control function. The refrigerant control operates with subtle control corresponding to the heat load of the room and offers a more comfortable environment. The refrigerant control can also provide increased energy savings.

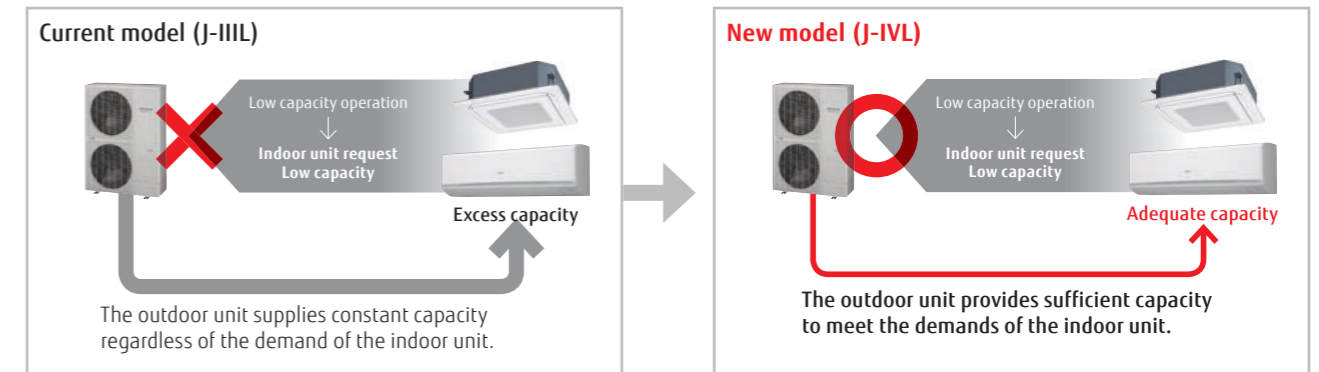

* The improvements due to the control and the actual sine wave vary depending on the combination of the indoor unit and system operating conditions.

External static pressure

External static pressure is available up to 60 Pa for 14/16/18 HP. (30 Pa for 8/10 HP, 40 Pa for 12 HP)

Capacities are slightly decreased relative to the rated values during high static pressure operations.



Advanced high-efficiency technology

Ø570 mm Large propeller fan
A large-diameter propeller fan with our proprietary blade design reduces draft loss, which results in high-efficiency and low noise operation.

DC fan motor
A small, multi-stage DC fan motor provides high-efficiency and low noise operation.

DC inverter control
The active filter module improves efficiency.

Subcooling heat exchanger
The dual-tube heat exchanger improves cooling performance.

Large heat exchanger
The large 2.6-row heat exchanger substantially improves heat-exchanging performance.

Scroll compressor
The combination of a scroll compressor with a wide rotational frequency range from 15 to 130 rps and our proprietary sensorless sine-wave control that smoothly controls the input power into the motor achieves more energy-efficient and quieter operation.



Fujitsu General offers a perfect total air conditioning system for small office buildings with multiple small rooms, taking into consideration energy savings, low noise, comfortable air volume, usage and purpose, and centralized control.

AIRSTAGE™ J-IVL

Image: 8/10/12 HP models

Slim & Compact Design

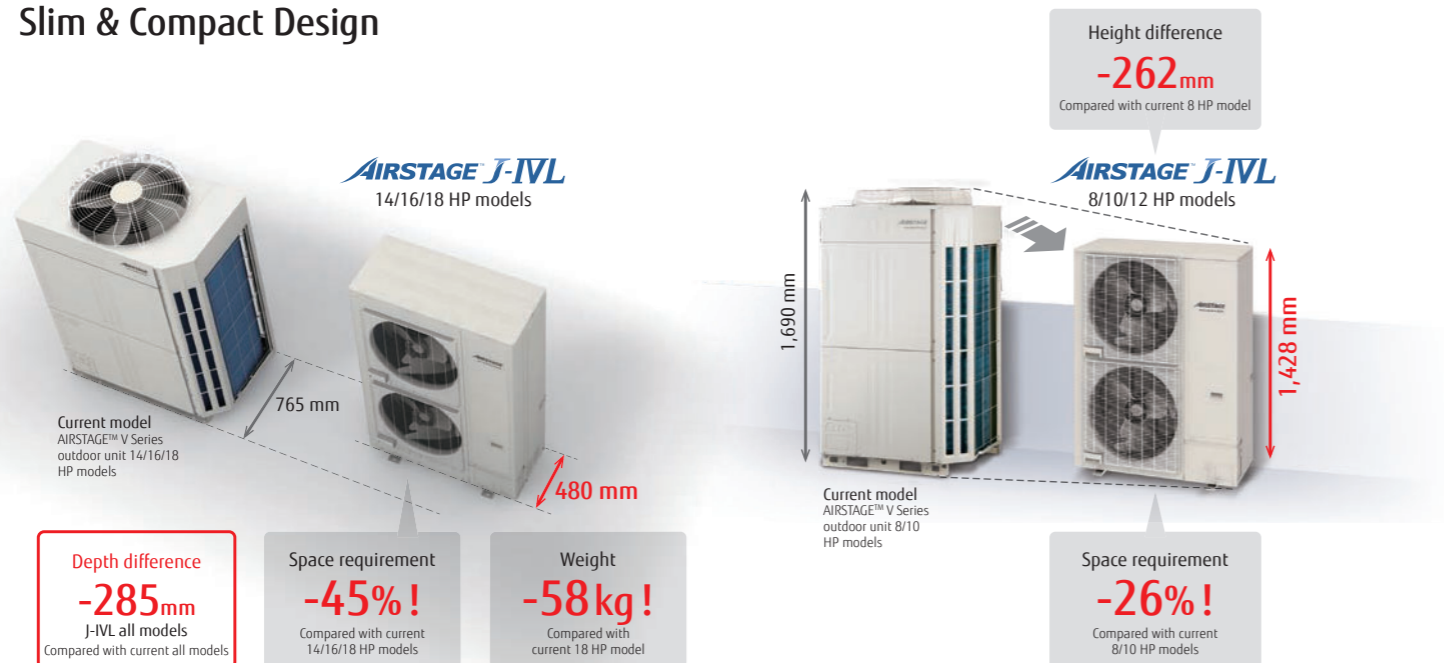

Various installation methods

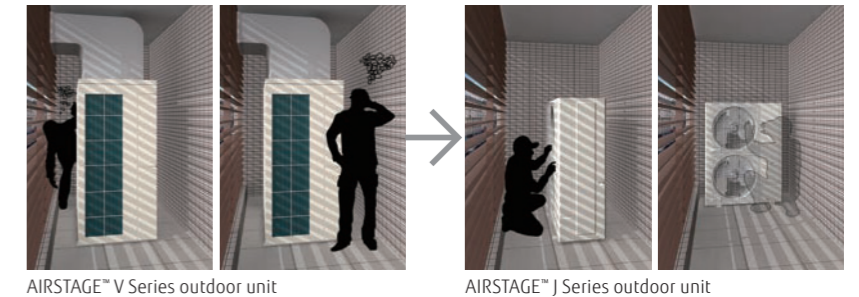

Installation
Low noise level in consideration of nearby residents

Front air discharge type with a width of about 1,000 mm, allowing for flexible installation even in narrow spaces.



Narrow space behind building
Space saving

Small and thin, allowing for direct ground or wall mounting installations even in narrow alleys.



Installation on the back street of a building
Flexible installation

Slim, low-body front air discharge meets the requirements for installation even in tight spaces. Installation flexibility without blocking the windows of buildings contributes to substantial space savings, even when multiple units are installed.

Efficiency in actual operating conditions

The use of a large heat exchanger and a high-efficiency Scroll compressor achieves class-leading EER/COP (Max. Heating) in all models.

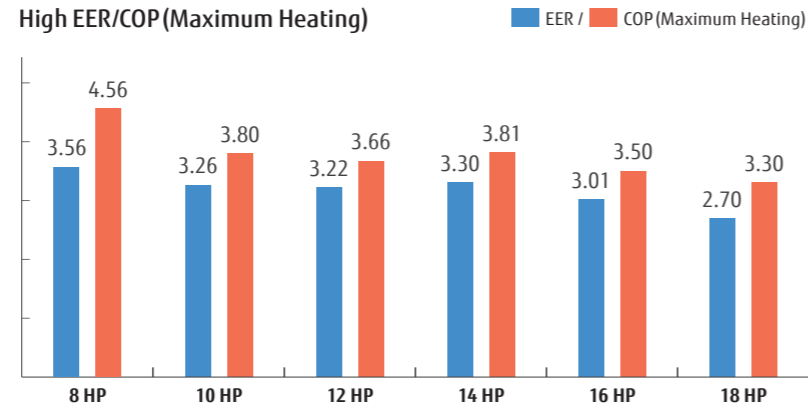

* These specifications are determined by cassette combination.

Long pipe length

Our advanced refrigerant control technology extends the maximum allowable length of refrigerant piping to 400 m. This provides high flexibility in system design.

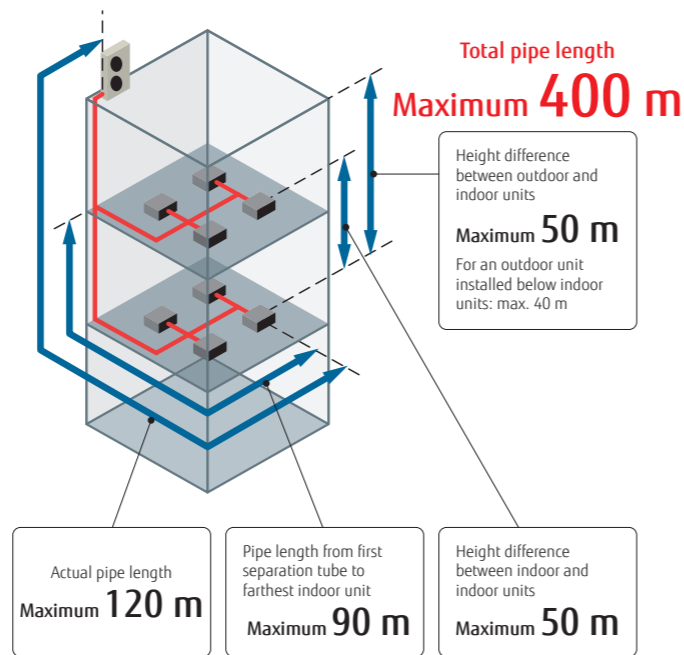

Up to 42 indoor units* can be connected.

The combination of smaller but sufficiently powerful indoor units and a new outdoor unit with an optimized heat exchanging structure makes it possible to connect up to 42 indoor units, which is the best in its class. *: 18 HP model

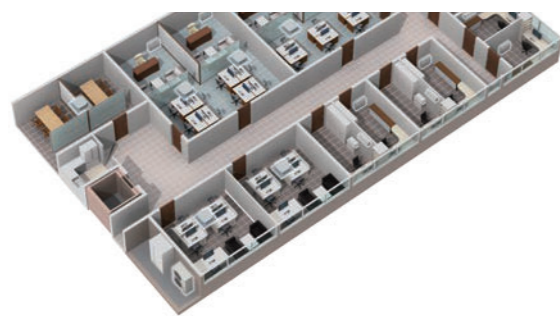

Class-leading Low Operating Sound

The top-class low operating noise makes it ideal for use in densely populated areas. These low operating sound models are ideal for installation in densely populated areas.

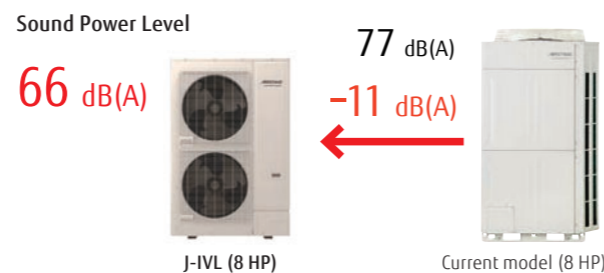

8,10,12 HP: AJY072LELBH/AJY090LELBH/AJY108LELBH
14,16,18 HP: AJY126LELBH/AJY144LELBH/AJY162LELBH



Specifications

Rated capacity range		HP	8	10	12	14	16	18
Model name			AJY072LELBH	AJY090LELBH	AJY108LELBH	AJY126LELBH	AJY144LELBH	AJY162LELBH
Maximum connectable indoor units			1-20	1-25	1-30	1-36	1-40	1-42
Power source			3-phase, ~400 V, 50 Hz					
Capacity	Cooling	kW	22.4	28.0	33.5	40.0	45.0	50.0
	Nominal Heating	kW	22.4	28.0	33.5	40.0	45.0	50.0
	Max. Heating	kW	25.0	31.5	37.5	45.0	50.0	55.0
Input power	Cooling	kW	6.30	8.59	10.42	12.12	14.96	18.52
	Nominal Heating	kW	4.65	6.61	8.18	9.71	11.81	13.66
	Max. Heating	kW	5.45	8.29	10.25	11.80	14.29	16.66
EER	Cooling		3.56	3.26	3.22	3.30	3.01	2.70
COP	Nominal Heating	W/W	4.82	4.24	4.10	4.12	3.81	3.66
	Max. Heating	W/W	4.56	3.80	3.66	3.81	3.50	3.30
Airflow rate		m ³ /h	8,400	9,000	11,000/12,100	13,000	14,000	14,800/15,300
Sound pressure level/Power level	Cooling	dB(A)	52/66	54/69	59/73	62/75	64/77	65/79
	Heating	dB(A)	54/-	57/-	62/-	63/-	65/-	68/-
Net Dimensions	Height	mm	1,428	1,428	1,428	1,638	1,638	1,638
	Width	mm	1,080	1,080	1,080	1,080	1,080	1,080
	Depth	mm	480	480	480	480	480	480
Weight		kg	170	177	178	213	213	217
Refrigerant	Type (Global Warming Potential)		R410A (2,088)	R410A (2,088)	R410A (2,088)	R410A (2,088)	R410A (2,088)	R410A (2,088)
	Charge	kg (CO ₂ eq-T)	7.0 (14.6)	7.5 (15.7)	7.5 (15.7)	11.0 (22.9)	11.0 (22.9)	11.8 (24.6)
Connection pipe diameter	Liquid	mm	9.52	9.52	12.70	12.70	12.70	12.70
	Gas	mm	19.05	22.20	28.58	28.58	28.58	28.58
Total pipe length		m	400	400	400	400	400	
Max. height difference			50/40 (Outdoor unit: Upper/Lower)					
Operating Range	Cooling	°C	-15 to 46	-15 to 46	-15 to 46	-5 to 46*	-5 to 46*	-5 to 46*
	Heating	°C	-20 to 21	-20 to 21	-20 to 21	-20 to 21	-20 to 21	-20 to 21

Note: Specifications are based on the following conditions.

Cooling: Indoor temperature of 27°CDB/19°CWB, and outdoor temperature of 35°CDB/24°CWB.

Heating: Indoor temperature of 20°CDB/(15°CWB), and outdoor temperature of 7°CDB/6°CWB.

Pipe length: 7.5 m; Height difference between outdoor unit and indoor unit: 0 m.

* The cooling operating range of -15 to 46°C can be obtained only when all of the indoor units connected to the system have a capacity of 5.6 kW or higher.

* These specifications are determined by cassette combination.

Dimensions

(Unit: mm)

8, 10, 12 HP

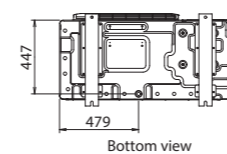
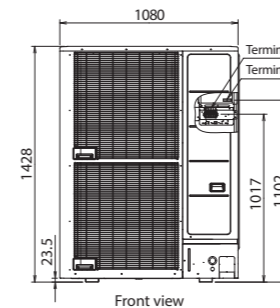
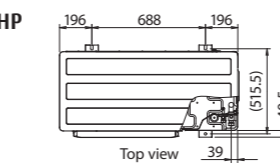

14, 16, 18 HP

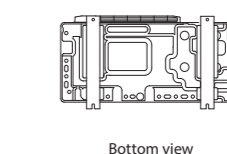
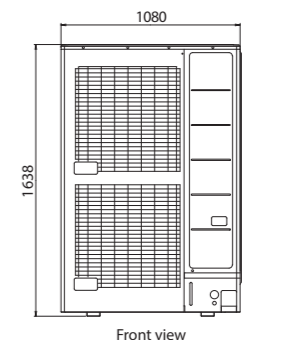
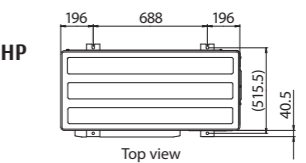

Heat Pump

for Small-capacity type



System configuration example

- Suitable for air conditioning small and medium-size buildings. One refrigerant system is used for each outdoor unit.
- Multiple indoor units are connected with separation tubes and headers.

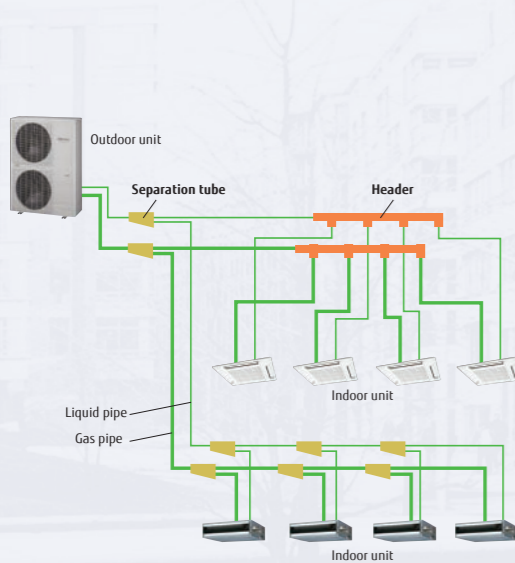

New intelligent refrigerant control

Fujitsu General is proposing outdoor units equipped with refrigerant control function. The refrigerant control operates with subtle control corresponding to the heat load of the room and offers a more comfortable environment. The refrigerant control can also provide increased energy savings.

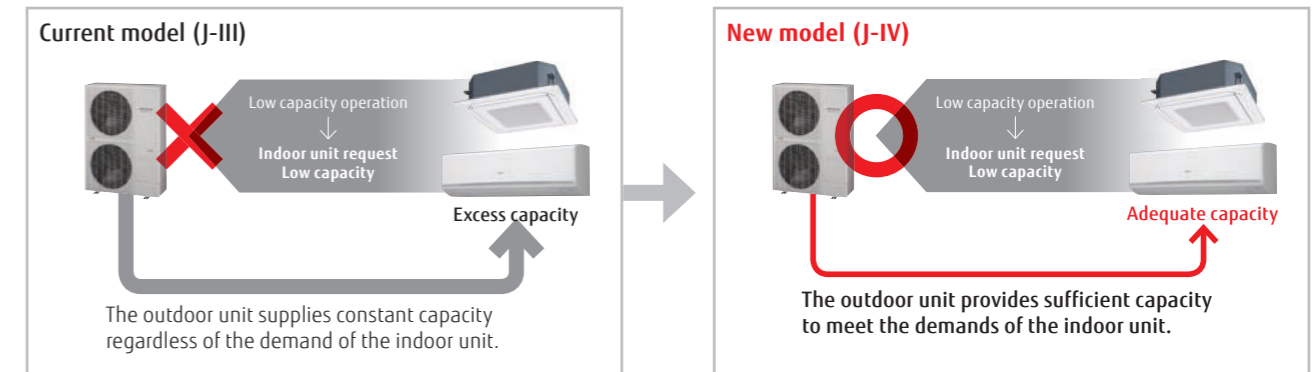

* The improvements due to the control and the actual sine wave vary depending on the combination of the indoor unit and system operating conditions.

External static pressure

External static pressure measures up to 30 Pa for 4/5/6 HP.



Advanced high-efficiency technology

Large propeller fan
A large propeller fan with an optimized blade angle achieves both high performance and low noise operation.

DC fan motor
A small, multi-stage DC fan motor contributes to high-efficiency and low noise operation.

Large heat exchanger
The large 3-row heat exchanger substantially improves heat-exchanging performance.

DC twin-rotary compressor
High-efficiency is achieved across compressor loads. Especially good performance is achieved in the low- to medium-load range.

Subcooling heat exchanger
The dual-tube heat exchanger improves cooling performance.

DC inverter control
The active filter module improves efficiency.

High-efficiency compressor motor
Optimized refrigerant flow design
Highly accurate parts

Pressure vs. Enthalpy graph showing 'effect' and 'Cooling performance improved'.

Compressor efficiency vs. Compressor capacity graph showing 'DC Twin-Rotary Compressor'.

4,5,6HP: AJY040LBLEBH/AJY045LBLEBH/AJY054LBLEBH
AJY040LELBH [3-phase]/AJY045LELBH [3-phase]/AJY054LELBH [3-phase]



Efficiency in actual operating conditions

The use of a large heat exchanger and a high-efficiency Scroll compressor achieves class-leading EER/COP (Max. Heating) in all models.

High EER/COP (Maximum Heating)

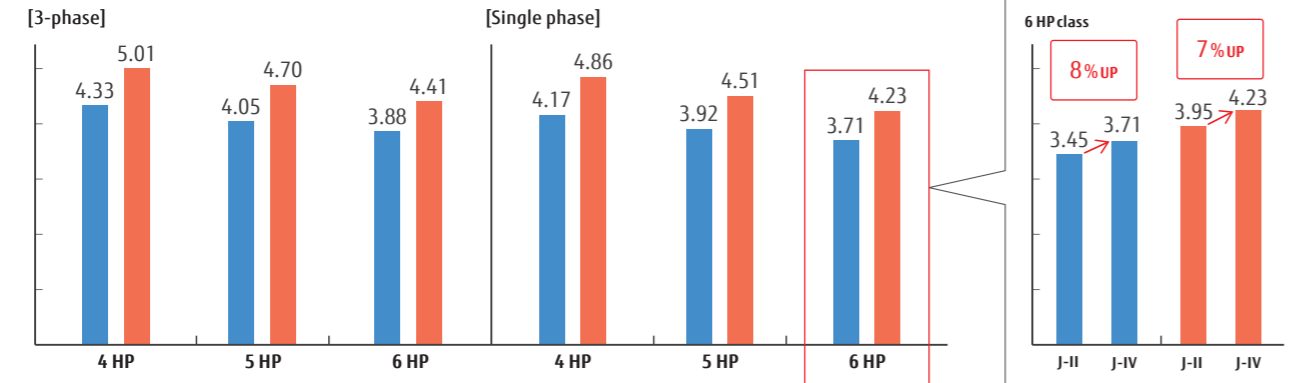

* These specifications are determined by cassette combination.

Long pipe length

Our advanced refrigerant control technology allows us to achieve a total refrigerant pipe length of 180 m. This provides high flexibility in system design.

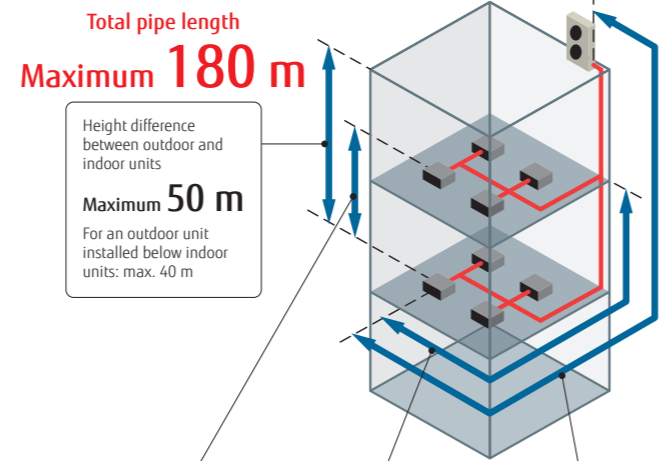

Up to 14 indoor units* can be connected

The combination of smaller but sufficiently powerful indoor units with an optimized heat exchanging structure makes it possible to connect up to 14 indoor units, which is the best in its class.

*: 6 HP model

Model	Current model (J-III)			New model (J-IV)		
	4	5	6	4	5	6
Rating Capacity range (HP)	4	5	6	4	5	6
Max. Connectable indoor unit	1-9	1-10	1-13	1-11	1-12	1-14

Non-stop oil recovery operation

A comfortable room condition is maintained during oil recovery mode because the product continues to operate without stopping the cooling or heating operation.

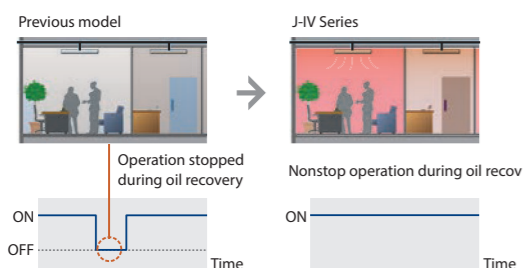

Easier Installation

Connection check function: Wiring connections and address settings can be checked thanks to the quick check run function.

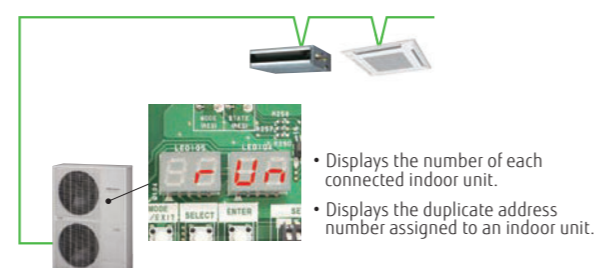

Specifications

Rated capacity range		HP	4	5	6
Model name			AJY040LBLEBH	AJY045LBLEBH	AJY054LBLEBH
Maximum connectable indoor units			1-11	1-12	1-14
Power source			Single phase, ~230 V, 50 Hz		
Capacity	Cooling	kW	12.1	14.0	15.5
	Nominal Heating		12.1	14.0	15.5
	Max. Heating		13.6	16.0	18.0
Input power	Cooling	kW	2.90	3.57	4.18
	Nominal Heating		2.39	2.97	3.50
	Max. Heating		2.80	3.55	4.26
EER	Cooling		4.17	3.92	3.71
	Nominal Heating	W/W	5.06	4.71	4.43
	Max. Heating		4.86	4.51	4.23
COP	Cooling		4.17	3.92	3.71
	Nominal Heating		5.06	4.71	4.43
	Max. Heating		4.86	4.51	4.23
Airflow rate		m ³ /h	6,200	6,400	6,900
Sound pressure level/Power level	Cooling	dB(A)	50/65	51/65	53/66
	Heating		52/67	55/69	56/69
Heat exchanger fin			Blue fin	Blue fin	Blue fin
Net Dimensions	Height	mm	1,334	1,334	1,334
	Width		970	970	970
	Depth		370	370	370
Weight		kg	117	117	119
	Refrigerant	Type (Global Warming Potential)	R410A (2,088)	R410A (2,088)	R410A (2,088)
Connection pipe diameter	Charge	kg (CO ₂ eq-T)	4.8 (10.0)	5.3 (11.1)	5.3 (11.1)
	Liquid	mm	9.52	9.52	9.52
Total pipe length	Gas		15.88	15.88	19.05
		m	180	180	180
Max. height difference			50/40 (Outdoor unit: Upper/Lower)		
Operating Range	Cooling	°C	-5 to 46	-5 to 46	-5 to 46
	Heating		-20 to 21	-20 to 21	-20 to 21

Note: Specifications are based on the following conditions.

Cooling: Indoor temperature of 27°CDB/19°CWB, and outdoor temperature of 35°CDB/24°CWB.
Heating: Indoor temperature of 20°CDB/15°CWB, and outdoor temperature of 7°CDB/6°CWB.
Pipe length: 7.5 m; Height difference between outdoor unit and indoor unit: 0 m.
Use outside the operating range may activate the protection function.

* These specifications are determined by cassette combination.

Dimensions

(Unit: mm)

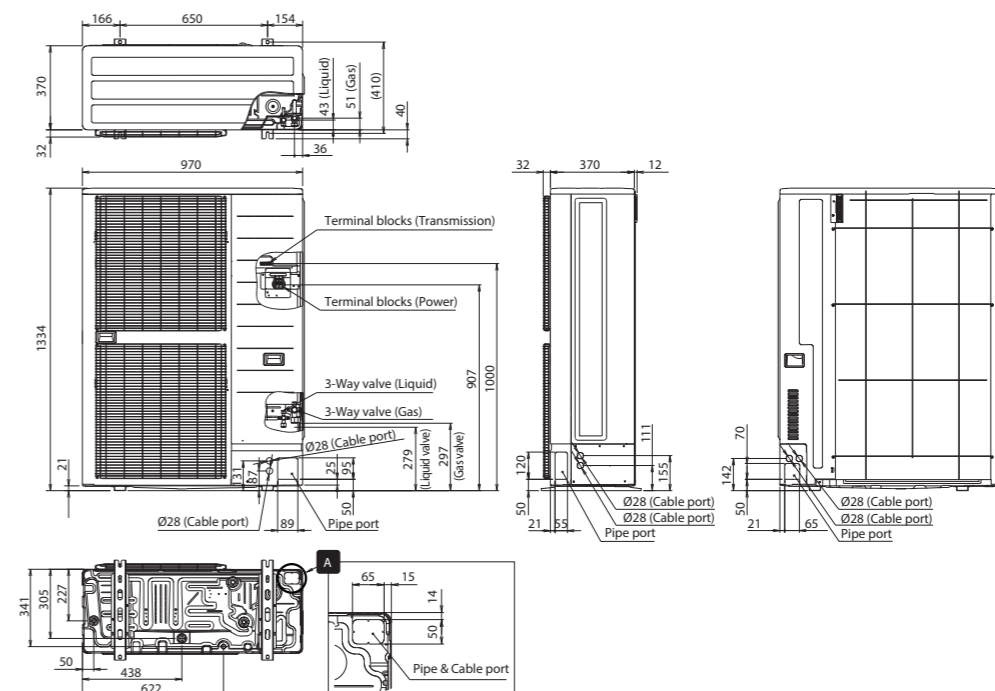

Heat Pump

for Small-capacity type



System configuration example

- Suitable for air conditioning small and medium-size buildings. One refrigerant system is used for each outdoor unit.
- Multiple indoor units are connected with separation tubes and headers.

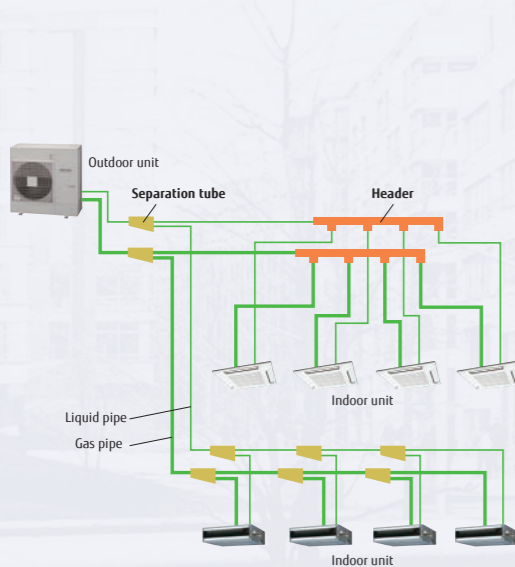

New intelligent refrigerant control

Fujitsu General is proposing outdoor units equipped with refrigerant control function. The refrigerant control operates with subtle control corresponding to the heat load of the room and offers a more comfortable environment. The refrigerant control can also provide increased energy savings.

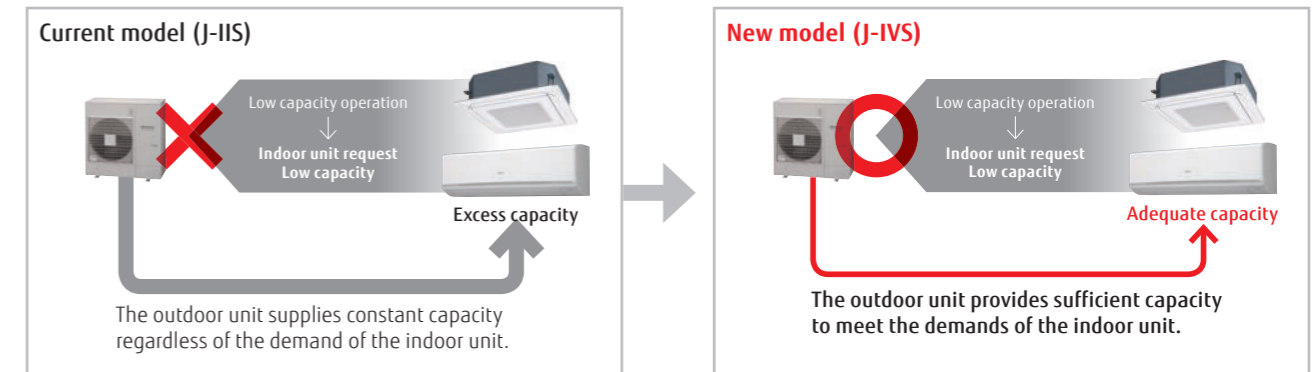

* The improvements due to the control and the actual sine wave vary depending on the combination of the indoor unit and system operating conditions.

External static pressure

External static pressure measures up to 25 Pa for 4/5/6 HP models.



Advanced high-efficiency technology

Large propeller fan
A large propeller fan with an optimized blade angle achieves both high performance and low noise operation.

DC fan motor
A small, multi-stage DC fan motor provides high-efficiency and low noise operation.

DC inverter control
The active filter module improves efficiency.

Large heat exchanger
The large 3-row heat exchanger substantially improves heat-exchanging performance.

Smooth airflow grille
The aerodynamically designed grille provides excellent efficiency with little blow loss.

Compact and high-performance DC twin-rotary compressor
High-efficiency is achieved across compressor loads. Especially good performance is achieved in the low- to medium-load range.

High heat-transfer copper tube (Improved lead angle)

Easy to carry, easy to install

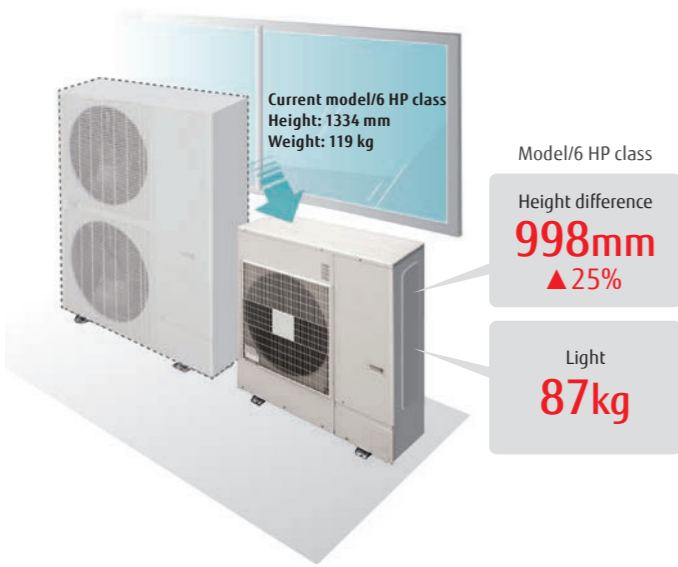

Small, lightweight outdoor unit

The outdoor units in this series are much more compact than conventional outdoor units of comparable capacity. They can be installed on a balcony, fitting below the height of the railing. With a height of less than 1 m, they can be installed in tight spaces such as under windows.

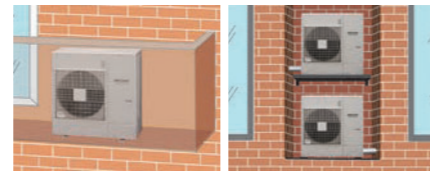

Low noise design

Significantly low noise levels are achieved by the use of a DC twin-rotary compressor, inverter technology, and an advanced airflow structure design.



Long pipe length

Our advanced refrigerant control technology extends the maximum allowable length of refrigerant piping to 80 m. This provides high flexibility in system design.

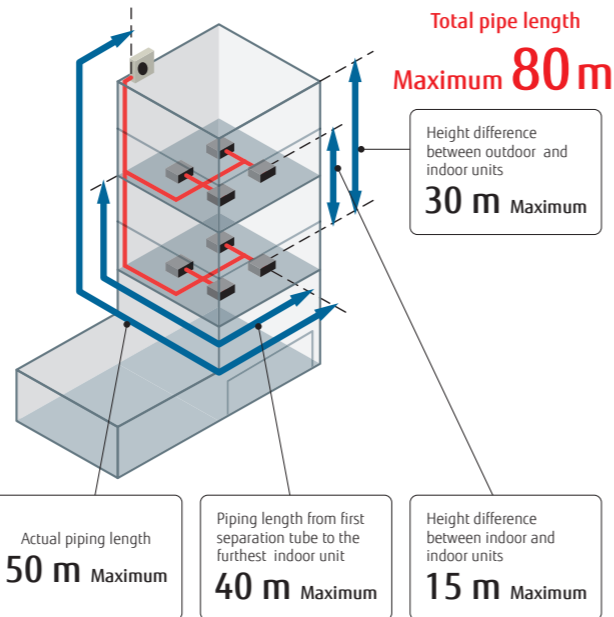

Up to 13 indoor units* can be connected

The combination of smaller but sufficiently powerful indoor units and a new outdoor unit with an optimized heat exchanging structure makes it possible to connect up to 13 indoor units, which is the best in its class.

*: 6 HP model

Model	Current model (J-IIS)			New model (J-IVS)		
	4	5	6	4	5	6
Rating Capacity range (HP)	4	5	6	4	5	6
Max. Connectable indoor unit	1-7	1-8	1-8	1-11	1-12	1-13

Non-stop oil recovery operation

A comfortable room condition is maintained during oil recovery mode because the product continues to operate without stopping the cooling or heating operation.

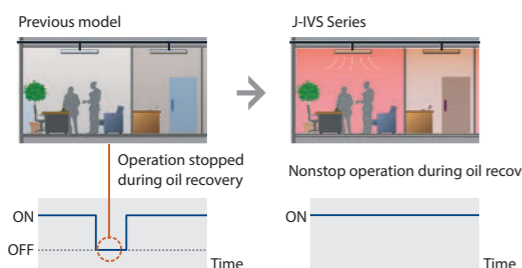

Easier Installation

Connection check function: Wiring connections and address settings can be checked thanks to the quick check run function.

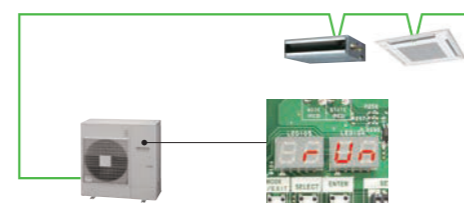

- Displays the number of each connected indoor unit.
- Displays the duplicate address number assigned to an indoor unit.

Specifications

Rated capacity range	HP	4	5	6
Model name		AJY040LCLBH	AJY045LCLBH	AJY054LCLBH
Maximum connectable indoor units		1-11	1-12	1-13
Power source		Single phase, ~230 V, 50 Hz		
Capacity	Cooling	12.1	14.0	15.1
	Nominal Heating	12.1	14.0	15.1
	Max. Heating	13.6	16.0	16.5
Input power	Cooling	3.44	4.43	5.03
	Nominal Heating	2.55	3.11	3.52
	Max. Heating	3.27	3.93	4.11
EER	Cooling	3.52	3.16	3.00
	Nominal Heating	4.74	4.51	4.30
	Max. Heating	4.16	4.07	4.01
COP	Cooling	4.04	4.20	4.20
	Nominal Heating	51/67	53/69	54/70
	Max. Heating	54/68	56/69	56/70
Airflow rate		4,040	4,200	4,200
Sound pressure level/ Power level	Cooling	51/67	53/69	54/70
	Heating	54/68	56/69	56/70
Heat exchanger fin	Height	Blue fin	Blue fin	Blue fin
	Width	998	998	998
	Depth	970	970	970
Net Dimensions	Height	370	370	370
	Width	86	86	87
	Depth	86	86	87
Weight	Type (Global Warming Potential)	R410A (2,088)	R410A (2,088)	R410A (2,088)
	Charge	4.0 (8.4)	4.0 (8.4)	4.0 (8.4)
	kg (CO ₂ eq-T)	4.0 (8.4)	4.0 (8.4)	4.0 (8.4)
Refrigerant	Liquid	9.52	9.52	9.52
	Gas	15.88	15.88	15.88
Connection pipe diameter	Total pipe length	80	80	80
	Max. height difference	30	30	30
Operating Range	Cooling	-5 to 46	-5 to 46	-5 to 46
	Heating	-20 to 21	-20 to 21	-20 to 21

Note: Specifications are subject to the following conditions:
 Cooling: Indoor temperature of 27°CDB/19°CWB, and outdoor temperature of 35°CDB/24°CWB.
 Heating: Indoor temperature of 20°CDB/(15°CWB), and outdoor temperature of 7°CDB/6°CWB.
 Pipe length: 7.5 m; Height difference between outdoor unit and indoor unit: 0 m.
 Use outside the operating range may activate the protection function.
 * These specifications are determined by cassette combination.

Dimensions

(Unit: mm)

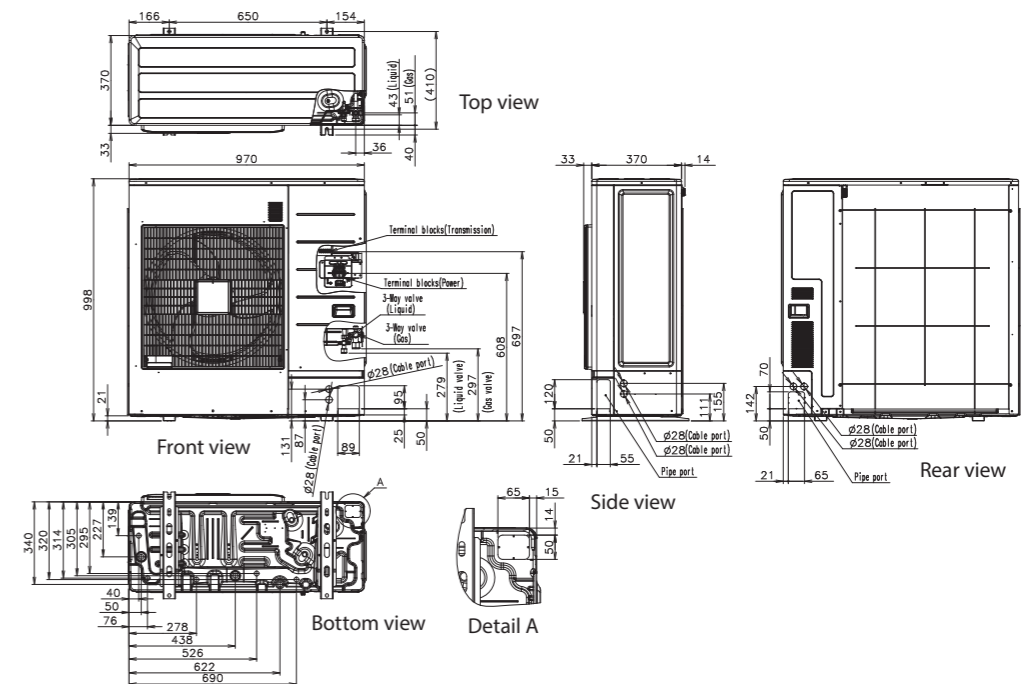

Heat Recovery

Modular Type



Highly energy-efficient operation

Our heat recovery systems achieve high operating energy efficiency by drawing heat from the room to be cooled and transferring it as energy for rooms that are to be heated.

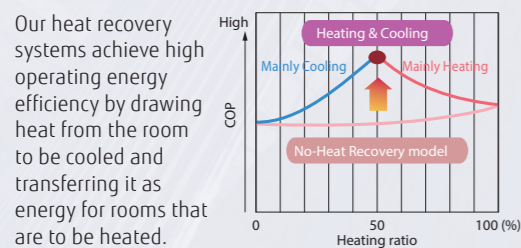
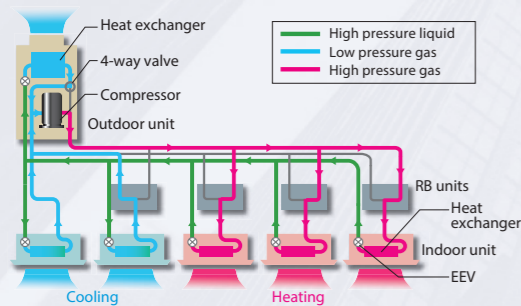

FUJITSU GENERAL (Euro) GmbH participates in the ECP program for VRF. Check ongoing validity of certificate: www.eurovent-certification.com

New intelligent refrigerant control

Fujitsu General is proposing outdoor units equipped with refrigerant control function. The refrigerant control operates with subtle control corresponding to the heat load of the room and offers a more comfortable environment. The refrigerant control can also provide increased energy savings.

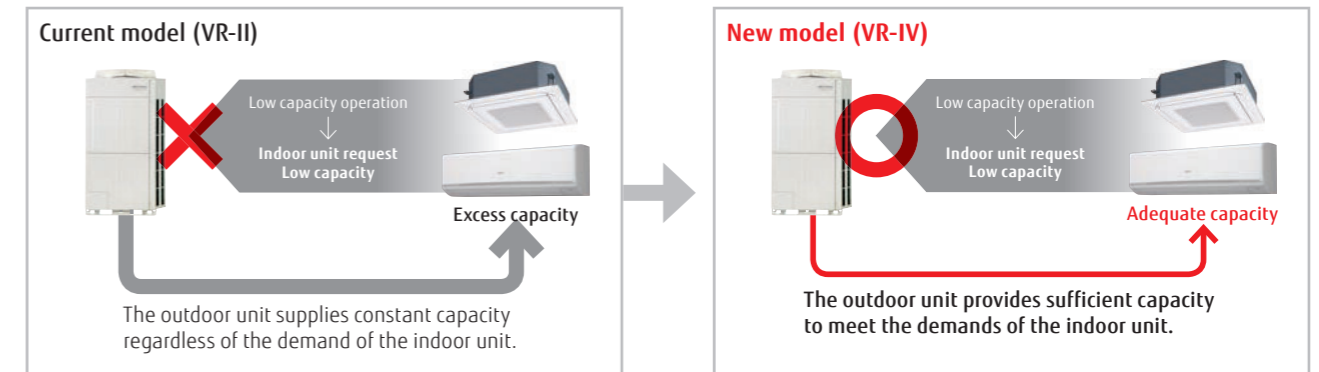

* The improvements due to the control and the actual sine wave vary depending on the combination of the indoor unit and system operating conditions.

Increase in the number of connectable indoor units

Capacity range of connectable indoor units

New model (VR-IV)	25%* to 150%
Current model (VR-II)	50% to 150%

*: For modular type, 25% to 49.9% operation in the entire system is available. (by one unit operation)

Increased number of connectable indoor units and space saving (Unit combinations)

HP	10	12	14	16	...	28	30	32	...	48	
New model (VR-IV)	21	26	30	34	...	60	64	64	...	64	
Current model (VR-II)	15	16	17	21	24	...	42	45	48	...	64

The energy-saving technology that boosted operation efficiency

- Powerful large propeller fan**
The fan uses CFD* technology to achieve both high performance and low noise operation.
*CFD: Computational Fluid Dynamics
- 3-phase DC fan motor**
The use of a DC fan motor with sophisticated driver control improves energy efficiency substantially. In addition, this motor operates quietly.
- Subcool heat exchanger**
High heat exchange efficiency is achieved by using an internal projection-shape double-pipe construction.
- High-efficient, large-capacity DC twin-rotary compressor**
Large-capacity high-efficient DC twin-rotary compressor with excellent intermediate capability.
- Sine-wave DC inverter control**
High-efficiency is realized by the adoption of reduced switching loss IPM.
- 4-face heat exchanger**
The 4-face heat exchanger increases the effective surface area and significantly improves heat-exchanging efficiency.
- Front intake port (Corner cut air inlet structure)**
In multiple outdoor unit installations, the unique front intake design improves airflow into the heat exchanger.

Extended connection ratio (applicable to multiple tenants)

Especially useful when starting partial air conditioning in a building under construction. Installation can be added flexibly for each tenant.



Stand-alone

Current model (VR-II)

Example) for 12 HP: 50% of 6 HP operation is required.

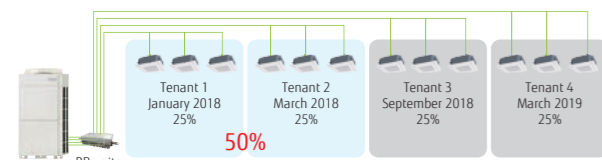

Installation is possible even for tenants who have not yet started operations.

New model (VR-IV)

Example) for 12 HP: Enables 25% of 3 HP operation.

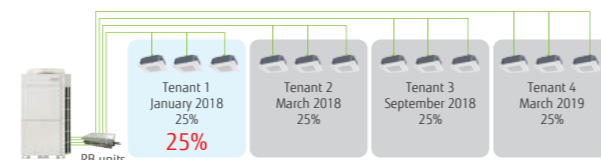

Installation and commissioning can be added flexibly to meet the opening dates of other tenants.

Modular type

One outdoor unit operates effectively for the capacities of connectable indoor units in the entire system. (Each of the multiple outdoor units does not dare to operate at 25% capacity: any one of the outdoor units will operate at 50% and the remaining units will each output 0%, i.e., stop operating.)

Example: One 5 HP outdoor unit performs 25% of 20 HP operation performed with two 10 HP outdoor units. One 10 HP outdoor unit performs 50% of 5 HP operation. → Two outdoor units do not perform 25% of the operation.

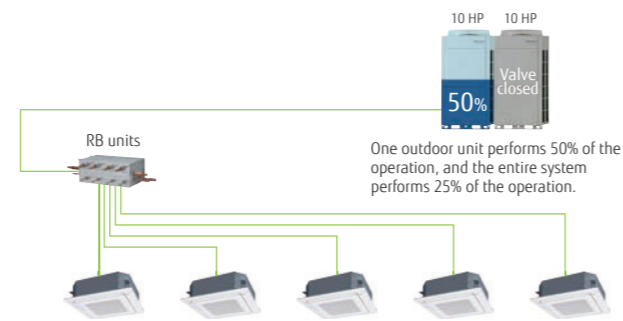

Additional installation is possible without changing the main pipe.

A main pipe of a diameter that can be used for the final system is installed at the beginning of the installation. Duplication of the work will be avoided as there is no need to change the main pipe as in the previous model.

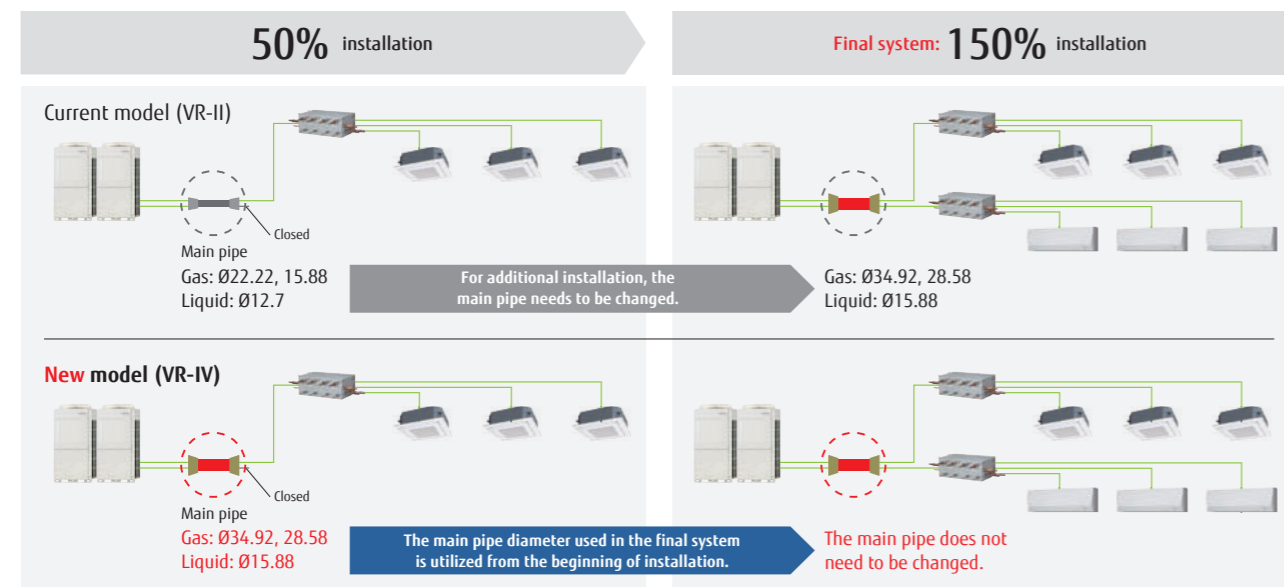

New Individual Defrost Operation

Individual Defrost Operation maintains the room comfortable during defrost operation.

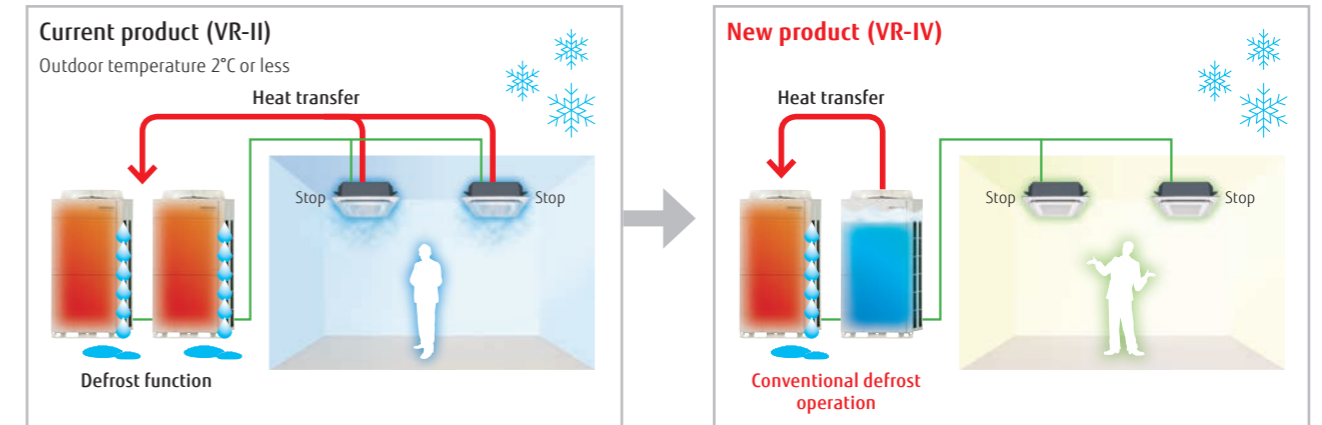

During defrosting operation, the system absorbs heat from the room to lower the room temperature.

Individual Defrost Operation absorbs the heat from the outside by using the remaining units to prevent an excessive drop in room temperature.

*Available only when the outdoor unit is modularly connected

Upon completion of Individual Defrost Operation, the indoor unit returns to normal operation.

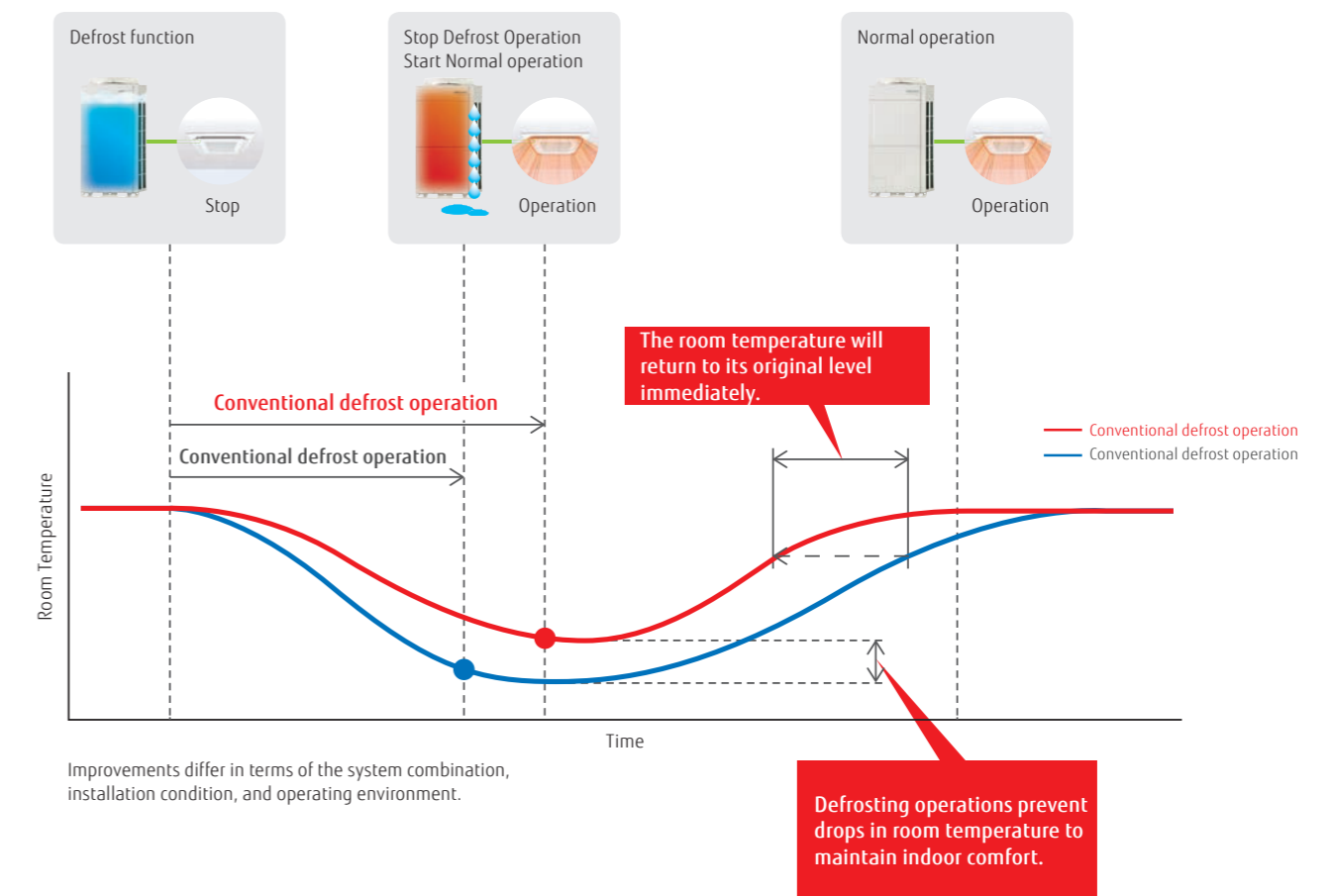

Improvements differ in terms of the system combination, installation condition, and operating environment.

Efficiency in actual operating conditions

Class-leading high COP (Maximum) The use of our proprietary heat exchanger structure and high-efficiency DC twin-rotary compressors achieves the class-leading coefficient of performance (COP) in every combination.

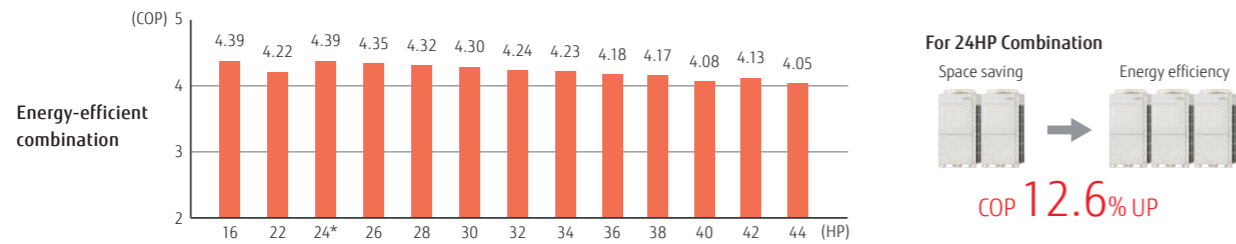
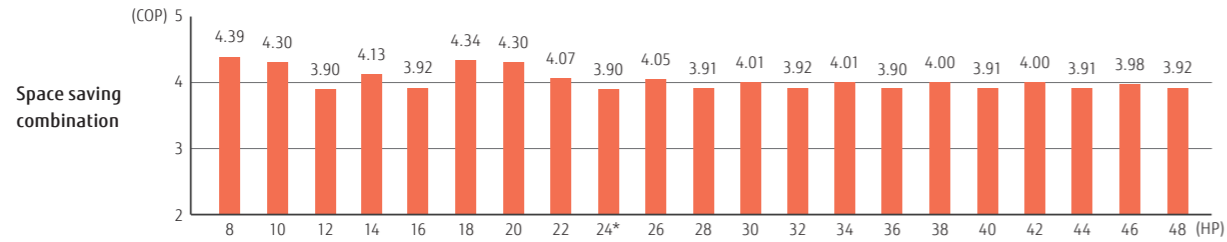

For 24HP Combination
Space saving → Energy efficiency
COP 12.6% UP

All-inverter compressor

Large-capacity DC inverter compressor

Large-capacity high-efficient DC twin-rotary compressor with excellent intermediate capability.



High-efficiency compressor speed control

The compressor speed control in 0.1 Hz increments ensures a comfortable space with less change in room temperature and less energy loss.

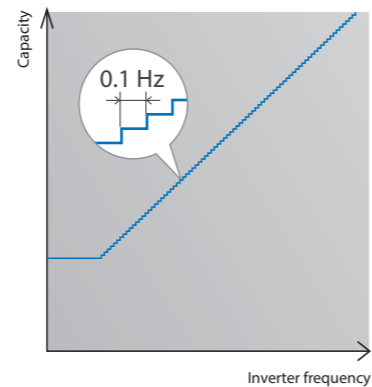

Multiple outdoor operation control

When multiple outdoor units are connected, each compressor carries out sophisticated operation. Instead of operating one compressor at full load to distribute the refrigerant to one heat exchanger, all compressors operate at partial load to distribute the refrigerant to all heat exchangers, thereby improving the efficiency of the entire system.

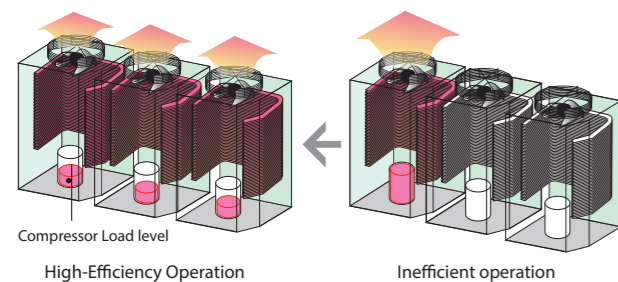

Heat exchanger refrigerant control

The heat exchanger in the outdoor unit is divided into two parts, upper and lower. The efficiency of the heat exchanger has been improved by adopting an optimum refrigerant path control where the refrigerant is distributed more into the top heat exchanger as this is where there is a greater air flow intake.

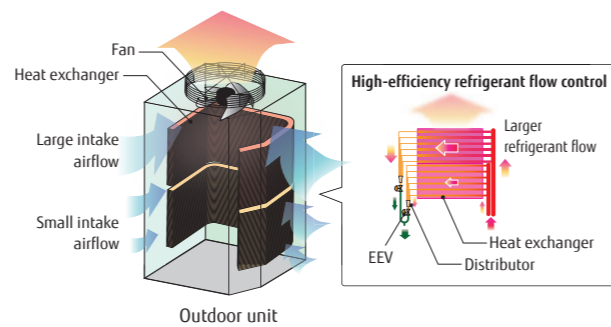

Flexible pipe connection

More flexible refrigerant pipe work is possible due to the use of various piping and RB unit connections, for adjustments to the floor layout and building structure.

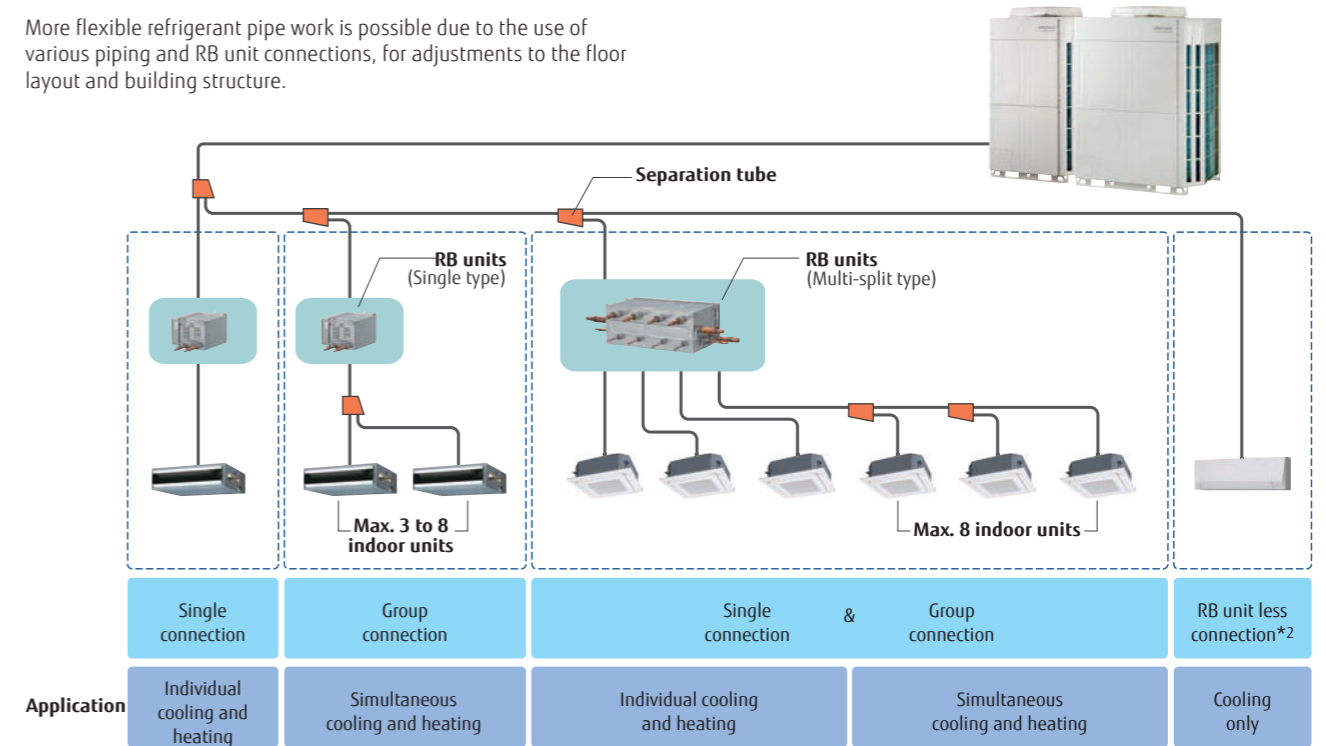

* An RB unit can be placed between the first branch and an indoor unit.
* The maximum height difference between RB units is 15 m.
No RB Unit is required for cooling only use.

Flexible installation of RB unit

Small and slim design with a height of 198 mm makes it easy to install in tight spaces with height constraints.

- A drain pipe is not required.
- Different positions of a control box can be chosen to accommodate installation conditions.
- Series connection for simplified installation



An RB unit can be installed on either side of the control box.
An RB unit can be installed on top of the control box to save space.
*: RB unit (single type)

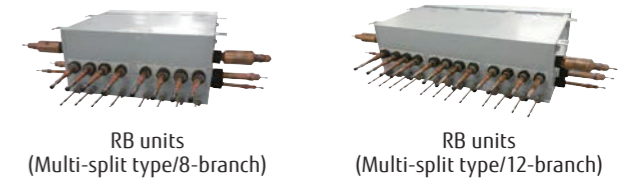
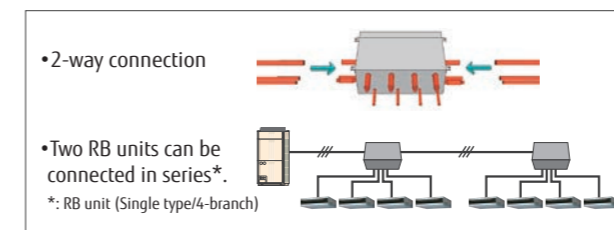

Easy maintenance in tight spaces

Maintenance can be performed from the side.

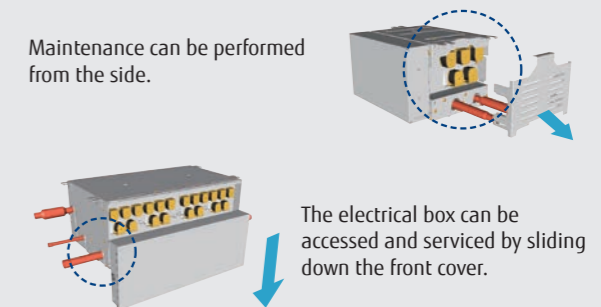

Parts can be accessed and replaced easily even in tight spaces inside the ceiling.

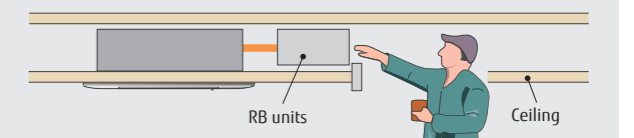

Outdoor units lineup • Combinations other than those listed below are not recommended.

Space saving combination

22.4kW (8HP) AJY072GALBH UNIT : AJY072GALBH	28.0kW (10HP) AJY090GALBH UNIT : AJY090GALBH	33.5kW (12HP) AJY108GALBH UNIT : AJY108GALBH	40.0kW (14HP) AJY126GALBH UNIT : AJY126GALBH	45.0kW (16HP) AJY144GALBH UNIT : AJY144GALBH
50.4kW (18HP) AJY162GALBH UNIT : AJY090/072GALBH	56.0kW (20HP) AJY180GALBH UNIT : AJY090/090GALBH	61.5kW (22HP) AJY198GALBH UNIT : AJY108/090GALBH	67.0kW (24HP) AJY216GALBH UNIT : AJY108/108GALBH	73.0kW (26HP) AJY234GALBH UNIT : AJY144/090GALBH
78.5kW (28HP) AJY252GALBH UNIT : AJY144/108GALBH	85.0kW (30HP) AJY270GALBH UNIT : AJY144/126GALBH	90.0kW (32HP) AJY288GALBH UNIT : AJY144/144GALBH	95.0kW (34HP) AJY306GALBH UNIT : AJY108/108/090GALBH	100.5kW (36HP) AJY324GALBH UNIT : AJY108/108/108GALBH
106.5kW (38HP) AJY342GALBH UNIT : AJY144/108/090GALBH	112.0kW (40HP) AJY360GALBH UNIT : AJY144/108/108GALBH	118.0kW (42HP) AJY378GALBH UNIT : AJY144/144/090GALBH	123.5kW (44HP) AJY396GALBH UNIT : AJY144/144/108GALBH	130.0kW (46HP) AJY414GALBH UNIT : AJY144/144/126GALBH
135.0kW (48HP) AJY432GALBH UNIT : AJY144/144/144GALBH				

Energy efficiency combination

44.8kW (16HP) AJY144GALBHH UNIT : AJY072/072GALBH	62.4kW (22HP) AJY198GALBHH UNIT : AJY126/072GALBH	67.2kW (24HP) AJY216GALBHH UNIT : AJY072/072/072GALBH	72.8kW (26HP) AJY234GALBHH UNIT : AJY090/072/072GALBH	78.4kW (28HP) AJY252GALBHH UNIT : AJY090/090/072GALBH
84.0kW (30HP) AJY270GALBHH UNIT : AJY090/090/090GALBH	90.4kW (32HP) AJY288GALBHH UNIT : AJY126/090/072GALBH	96.0kW (34HP) AJY306GALBHH UNIT : AJY126/090/090GALBH	102.4kW (36HP) AJY324GALBHH UNIT : AJY126/126/072GALBH	108.0kW (38HP) AJY342GALBHH UNIT : AJY126/126/090GALBH
113.0kW (40HP) AJY360GALBHH UNIT : AJY144/126/090GALBH	120.0kW (42HP) AJY378GALBHH UNIT : AJY126/126/126GALBH	125.0kW (44HP) AJY396GALBHH UNIT : AJY144/126/126GALBH		

8,10,12HP : AJY072GALBH / AJY090GALBH / AJY108GALBH
14,16HP : AJY126GALBH / AJY144GALBH



Dimensions

(Unit: mm)

8, 10, 12 HP

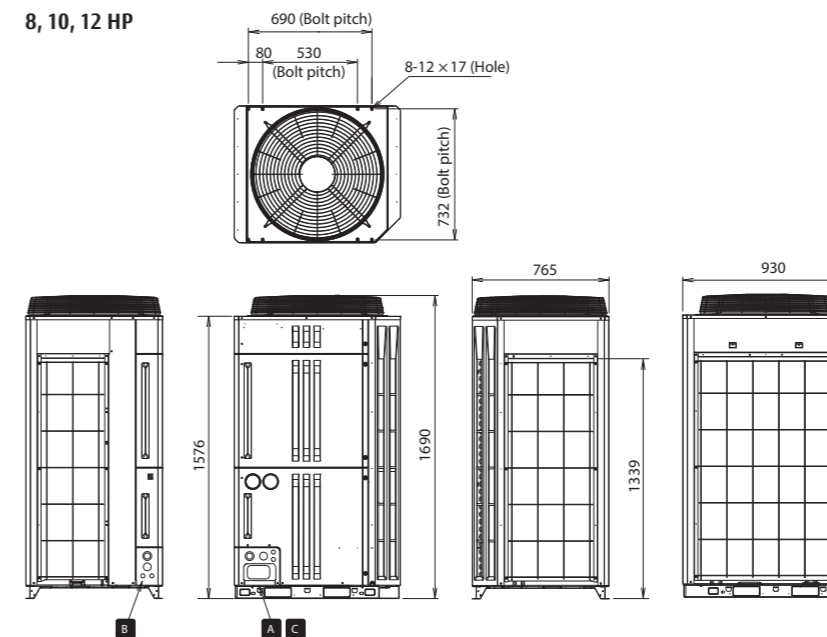

14, 16 HP

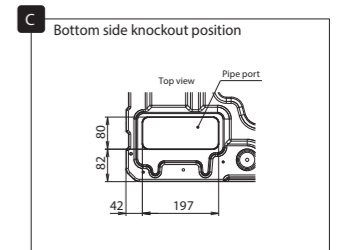
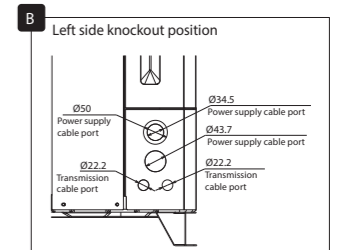
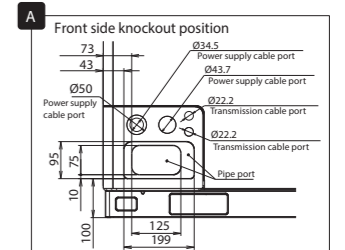
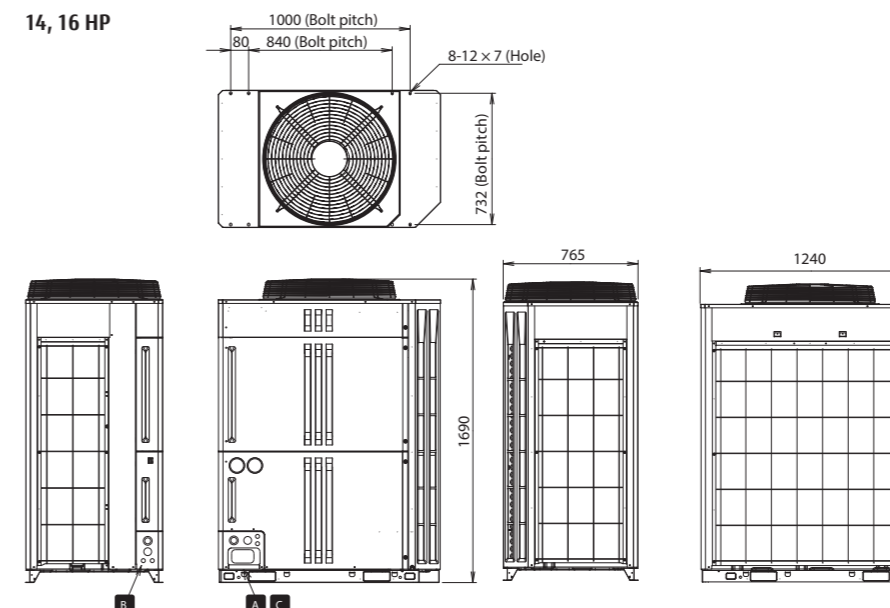

Outdoor unit specifications

Space saving combination

Rated capacity range	HP	8	10	12	14	16	18	20	22	24	26	28	30	32	34	36	38	40	42	44	46	48	
Model name		AJY072GALBH	AJY090GALBH	AJY108GALBH	AJY126GALBH	AJY144GALBH	AJY162GALBH	AJY180GALBH	AJY198GALBH	AJY216GALBH	AJY234GALBH	AJY252GALBH	AJY270GALBH	AJY288GALBH	AJY306GALBH	AJY324GALBH	AJY342GALBH	AJY360GALBH	AJY378GALBH	AJY396GALBH	AJY414GALBH	AJY432GALBH	
Unit 1 Unit 2 Unit 3		AJY072GALBH	AJY090GALBH	AJY108GALBH	AJY126GALBH	AJY144GALBH	AJY090GALBH AJY072GALBH	AJY090GALBH AJY090GALBH	AJY108GALBH AJY090GALBH	AJY108GALBH AJY108GALBH	AJY144GALBH AJY090GALBH	AJY144GALBH AJY108GALBH	AJY144GALBH AJY126GALBH	AJY144GALBH AJY144GALBH	AJY108GALBH AJY108GALBH AJY090GALBH	AJY108GALBH AJY108GALBH AJY108GALBH	AJY144GALBH AJY108GALBH AJY108GALBH	AJY144GALBH AJY108GALBH AJY108GALBH	AJY144GALBH AJY144GALBH AJY144GALBH	AJY144GALBH AJY144GALBH AJY144GALBH	AJY144GALBH AJY144GALBH AJY144GALBH	AJY144GALBH AJY144GALBH AJY144GALBH	
Maximum connectable indoor units*		17	21	26	30	34	39	43	47	52	56	60	64	64	64	64	64	64	64	64	64	64	
Connectable capacity range of indoor units	kW	5.6-33.6	7.0-42.0	8.4-50.2	10.0-60.0	11.3-67.5	12.6-75.6*3	14.0-84.0*3	15.4-92.2*3	16.8-100.5*3	18.3-109.5*3	19.7-117.7*3	21.3-127.5*3	22.5-135.0*3	23.8-142.5*3	25.2-150.7*3	26.7-159.7*3	28.0-168.0*3	29.5-177.0*3	30.9-185.2*3	32.5-195.0*3	33.8-202.5*3	
Power source		3 phase 4 wire, 400 V, 50Hz										3 phase 4 wire, 400 V, 50Hz											
Capacity	Cooling	22.4	28.0	33.5	40.0	45.0	50.4	56.0	61.5	67.0	73.0	78.5	85.0	90.0	95.0	100.5	106.5	112.0	118.0	123.5	130.0	135.0	
	Nominal Heating	22.4	28.0	33.5	40.0	45.0	-	-	-	-	-	-	-	-	-	-	-	-	-	-	-	-	
	Max. Heating	25.0	31.5	37.5	45.0	50.0	56.5	63.0	69.0	75.0	81.5	87.5	95.0	100.0	106.5	112.5	119.0	125.0	131.5	137.5	145.0	150.0	
Input power	Cooling	5.45	7.11	9.75	11.34	14.42	12.56	14.22	16.86	19.50	21.53	24.17	25.76	28.84	26.61	29.25	31.28	33.92	35.95	38.59	40.18	43.26	
	Nominal Heating	4.73	6.00	7.89	8.85	10.54	-	-	-	-	-	-	-	-	-	-	-	-	-	-	-	-	
	Max. Heating	5.70	7.33	9.62	10.90	12.77	13.03	14.66	16.95	19.24	20.10	22.39	23.67	25.54	26.57	28.86	29.72	32.01	32.87	35.16	36.44	38.31	
EER	Cooling	4.11	3.94	3.44	3.53	3.12	4.01	3.94	3.65	3.44	3.39	3.25	3.30	3.12	3.57	3.44	3.40	3.30	3.28	3.20	3.24	3.12	
COP	Nominal Heating	4.74	4.67	4.25	4.52	4.27	-	-	-	-	-	-	-	-	-	-	-	-	-	-	-	-	
	Max. Heating	4.39	4.30	3.90	4.13	3.92	4.34	4.30	4.07	3.90	4.05	3.91	4.01	3.92	4.01	3.90	4.00	3.91	4.00	3.91	3.98	3.92	
Airflow rate		11,100	11,100	11,100	13,000	13,000	11,100 × 2	11,100 × 2	11,100 × 2	11,100 × 2	13,000 + 11,100	13,000 + 11,100	13,000 × 2	13,000 × 2	11,100 × 3	11,100 × 3	13,000 + 11,100 × 2	13,000 + 11,100 × 2	13,000 × 2 + 11,100	13,000 × 2 + 11,100	13,000 × 3	13,000 × 3	
Sound pressure level**/Power level	Cooling	56 / 75	58 / 76	59 / 79	60 / 81	61 / 81	60 / 79	61 / 79	62 / 81	62 / 82	63 / 82	64 / 84	64 / 84	64 / 84	63 / 83	64 / 84	63 / 83	64 / 84	65 / 85	65 / 85	65 / 85	66 / 86	66 / 86
	Heating	58 / 76	59 / 77	62 / 82	62 / 82	62 / 82	62 / 80	62 / 80	63 / 83	64 / 85	63 / 83	64 / 85	64 / 85	64 / 85	65 / 86	67 / 87	65 / 86	67 / 87	66 / 86	67 / 87	67 / 87	67 / 87	67 / 87
Max. External static pressure	Pa	80	80	80	80	80	80	80	80	80	80	80	80	80	80	80	80	80	80	80	80	80	
Compressor motor output	kW	7.5	7.5	7.5	11.0	11.0	7.5 × 2	7.5 × 2	7.5 × 2	7.5 × 2	11.0 + 7.5	11.0 + 7.5	11.0 × 2	11.0 × 2	7.5 × 3	7.5 × 3	11.0 + 7.5 × 2	11.0 + 7.5 × 2	11.0 × 2 + 7.5	11.0 × 2 + 7.5	11.0 × 3	11.0 × 3	
Heat exchanger fin	Blue fin	Blue fin	Blue fin	Blue fin	Blue fin	Blue fin	Blue fin	Blue fin	Blue fin	Blue fin	Blue fin	Blue fin	Blue fin	Blue fin	Blue fin	Blue fin	Blue fin	Blue fin	Blue fin	Blue fin	Blue fin	Blue fin	
	Height	1,690	1,690	1,690	1,690	1,690	1,690	1,690	1,690	1,690	1,690	1,690	1,690	1,690	1,690	1,690	1,690	1,690	1,690	1,690	1,690	1,690	
	Width	930	930	930	1,240	1,240	930 × 2	930 × 2	930 × 2	930 × 2	1,240 + 930	1,240 + 930	1,240 × 2	1,240 × 2	930 × 3	930 × 3	1,240 × 2 + 930	1,240 + 930 × 2	1,240 × 2 + 930	1,240 × 2 + 930	1,240 × 3	1,240 × 3	
Net Dimensions	Depth	765	765	765	765	765	765	765	765	765	765	765	765	765	765	765	765	765	765	765	765	765	
	Weight	262	262	262	286	286	262 × 2	262 × 2	262 × 2	262 × 2	286 + 262	286 + 262	286 × 2	286 × 2	262 × 3	262 × 3	286 + 262 × 2	286 + 262 × 2	286 × 2 + 262	286 × 2 + 262	286 × 3	286 × 3	
	Refrigerant	Type (Global Warming Potential)	R410A (2,088)	R410A (2,088)	R410A (2,088)	R410A (2,088)	R410A (2,088)	R410A (2,088)	R410A (2,088)	R410A (2,088)	R410A (2,088)	R410A (2,088)	R410A (2,088)	R410A (2,088)	R410A (2,088)	R410A (2,088)	R410A (2,088)	R410A (2,088)	R410A (2,088)	R410A (2,088)	R410A (2,088)	R410A (2,088)	
Connection pipe diameter	Liquid	12.70	12.70	12.70	12.70	12.70	15.88	15.88	15.88	15.88	15.88	15.88	19.05	19.05	19.05	19.05	19.05	19.05	19.05	19.05	19.05	19.05	
	Discharge Gas	15.88	19.05	19.05	22.22	22.22	22.22	22.22	22.22	22.22	28.58	28.58	28.58	28.58	28.58	28.58	34.92	34.92	34.92	34.92	34.92	34.92	
	Suction Gas	22.22	22.22	28.58	28.58	28.58	28.58	28.58	28.58	34.92	34.92	34.92	34.92	34.92	34.92	41.27	41.27	41.27	41.27	41.27	41.27	41.27	
Operating Range	Cooling	-10 to 46	-10 to 46	-10 to 46	-10 to 46	-10 to 46	-10 to 46	-10 to 46	-10 to 46	-10 to 46	-10 to 46	-10 to 46	-10 to 46	-10 to 46	-10 to 46	-10 to 46	-10 to 46	-10 to 46	-10 to 46	-10 to 46	-10 to 46	-10 to 46	
	Heating	-20 to 21	-20 to 21	-20 to 21	-20 to 21	-20 to 21	-20 to 21	-20 to 21	-20 to 21	-20 to 21	-20 to 21	-20 to 21	-20 to 21	-20 to 21	-20 to 21	-20 to 21	-20 to 21	-20 to 21	-20 to 21	-20 to 21	-20 to 21	-20 to 21	
	Cooling/Heating	-10 to 21	-10 to 21	-10 to 21	-10 to 21	-10 to 21	-10 to 21	-10 to 21	-10 to 21	-10 to 21	-10 to 21	-10 to 21	-10 to 21	-10 to 21	-10 to 21	-10 to 21	-10 to 21	-10 to 21	-10 to 21	-10 to 21	-10 to 21	-10 to 21	

Energy Efficiency Combination

Rated capacity range	HP	16	22	24	26	28	30	32	34	36	38	40	42	44	
Model name		AJY144GALBHH	AJY198GALBHH	AJY216GALBHH	AJY234GALBHH	AJY252GALBHH	AJY270GALBHH	AJY288GALBHH	AJY306GALBHH	AJY324GALBHH	AJY342GALBHH	AJY360GALBHH	AJY378GALBHH	AJY396GALBHH	
Unit 1 Unit 2 Unit 3		AJY072GALBH AJY072GALBH	AJY126GALBH AJY072GALBH	AJY072GALBH AJY072GALBH AJY072GALBH	AJY090GALBH AJY072GALBH AJY072GALBH	AJY090GALBH AJY090GALBH AJY072GALBH	AJY090GALBH AJY090GALBH AJY072GALBH	AJY126GALBH AJY090GALBH AJY072GALBH	AJY126GALBH AJY090GALBH AJY090GALBH	AJY126GALBH AJY126GALBH AJY090GALBH	AJY126GALBH AJY126GALBH AJY090GALBH	AJY126GALBH AJY126GALBH AJY090GALBH	AJY126GALBH AJY126GALBH AJY090GALBH	AJY126GALBH AJY126GALBH AJY126GALBH	
Maximum connectable indoor units*		34	47	52	56	60	64	64	64	64	64	64	64	64	
Connectable capacity range of indoor units	kW	11.2-67.2*3	15.6-93.6*3	16.8-100.8*3	18.2-109.2*3	19.6-117.6*3	21.0-126.0*3	22.6-135.6*3	24.0-144.0*3	25.6-153.6*3	27.0-162.0*3	28.3-169.5*3	30.0-180.0*3	31.3-187.5*3	
Power source		3 phase 4 wire, 400 V, 50Hz							3 phase 4 wire, 400 V, 50Hz						
Capacity	Cooling	44.8	62.4	67.2	72.8	78.4	84.0	90.4	96.0	102.4	108.0	113.0	120.0	125.0	
	Nominal Heating	-	-	-	-	-	-	-	-	-	-	-	-	-	
	Max. Heating	50.0	70.0	75.0	81.5	88.0	94.5	101.5	108.0	115.0	121.5	126.5	135.0	140.0	
Input power	Cooling	10.90	16.79	16.35	18.01	19.67	21.33	23.90	25.56	28.13	29.79	32.87	34.02	37.10	
	Nominal Heating	-	-	-	-	-	-	-	-	-	-	-	-	-	
	Max. Heating	11.40	16.60	17.10	18.73	20.36	21.99	23.93	25.56	27.50	29.13	31.00	32.70	34.57	
EER	Cooling	4.11	3.72	4.11	4.04	3.99	3.94	3.78	3.76	3.64	3.63	3.44	3.53	3.37	
COP	Nominal Heating	-	-	-	-	-	-	-	-	-	-	-	-	-	
	Max. Heating	4.39	4.22	4.39	4.35	4.32	4.30	4.24	4.23	4.18	4.17	4.08	4.13	4.05	
Airflow rate		11,100 × 2	13,000 + 11,100	11,100 × 3	11,100 × 3	11,100 × 3	11,100 × 3	13,000 + 11,100 × 2	13,000 + 11,100 × 2	13,000 × 2 + 11,100	13,000 × 2 + 11,100	13,000 × 2 + 11,100	13,000 × 3	13,000 × 3	
Sound pressure level**/Power level	Cooling	59 / 78	61 / 82	61 / 80	62 / 80	62 / 80	63 / 81	63 / 83	64 / 83	64 / 85	64 / 85	65 / 85	65 / 86	65 / 86	
	Heating	61 / 79	63 / 83	63 / 81	63 / 81	63 / 81	64 / 82	64 / 84	65 / 84	66 / 86	66 / 86	66 / 86	67 / 87	67 / 87	
Max. External static pressure	Pa	80	80	80	80	80	80	80	80	80	80	80	80	80	
Compressor motor output	kW	7.5 × 2	11.0 + 7.5	7.5 × 3	7.5 × 3	7.5 × 3	7.5 × 3	11.0 + 7.5 × 2	11.0 + 7.5 × 2	11.0 × 2 + 7.5	11.0 × 2 + 7.5	11.0 × 2 + 7.5	11.0 × 3	11.0 × 3	
Heat exchanger fin	Blue fin	Blue fin	Blue fin	Blue fin	Blue fin	Blue fin	Blue fin	Blue fin	Blue fin	Blue fin	Blue fin	Blue fin	Blue fin	Blue fin	
	Height	1,690	1,690												

Heat Pump

Modular Type



System configuration example

- Suitable for air conditioning midsize and large buildings. Connecting each outdoor unit makes it possible to create a high-capacity system.
- Multiple indoor units are connected with separation tubes and headers.

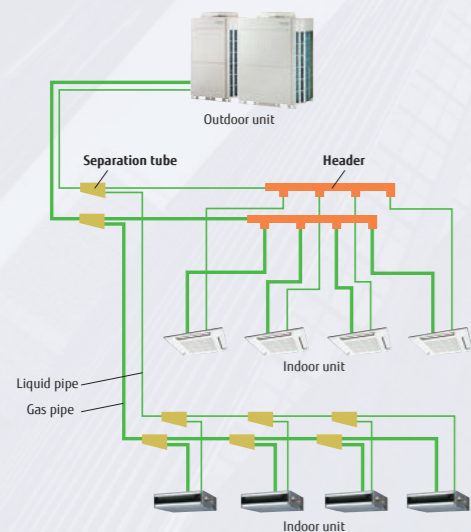

FUJITSU GENERAL (Euro) GmbH participates in the ECP program for VRF. Check ongoing validity of certificate: www.eurovent-certification.com

Efficiency in actual operating conditions

The use of our proprietary heat exchanger structure and high-efficiency DC twin-rotary compressors achieves the class-leading coefficient of performance (COP) in every combination.

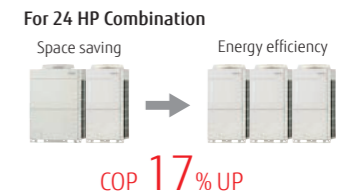
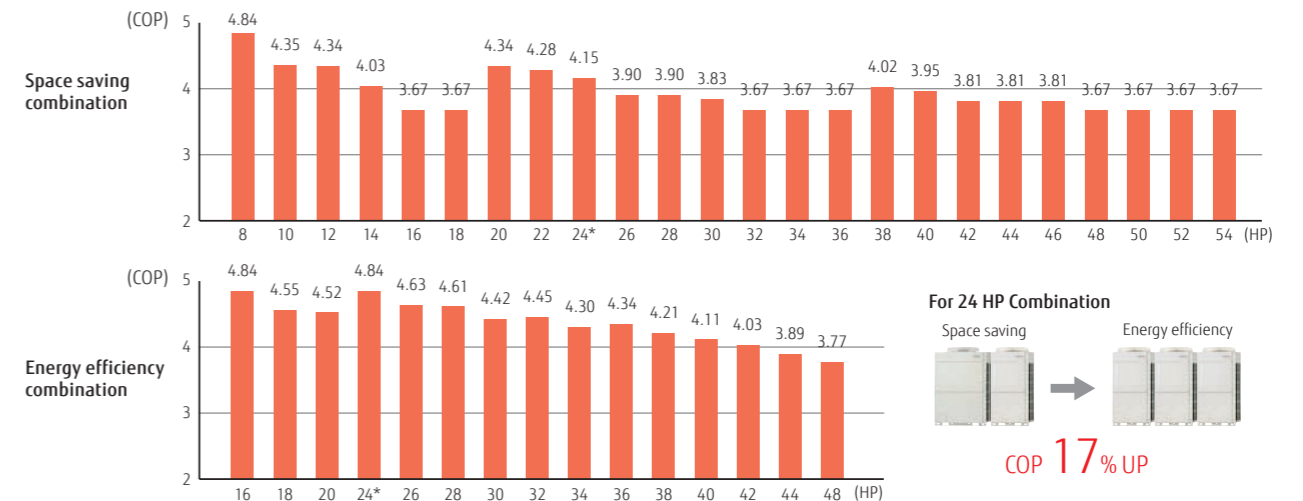

* These specifications are determined by ducted combination.
* Multiple outdoor units are not certified by Eurovent.

The energy-saving technology that boosted operation efficiency



- Powerful large propeller fan**
The fan uses CFD* technology to achieve both high performance and low noise operation. *CFD: Computational Fluid Dynamics
- 3-phase DC fan motor**
The use of a DC fan motor with sophisticated driver control improves energy efficiency substantially. In addition, low noise is realized by the DC fan motor.
- Sine-wave DC inverter control**
High-efficiency is realized by the adoption of reduced switching loss IPM.
- 4-face heat exchanger**
The 4-face heat exchanger increases the effective surface area and significantly improves heat-exchanging efficiency.
- Subcool heat exchanger**
High heat exchange efficiency is achieved by using an internal projection-shape double-pipe construction.
- High-efficient, large-capacity DC twin-rotary compressor**
Large-capacity high-efficient DC twin-rotary compressor with excellent intermediate capability.
- Front intake port (Corner cut air inlet structure)**
In multiple outdoor unit installations, the unique front intake design improves airflow into the heat exchanger.

Advanced energy-saving control

Multiple outdoor operation control

Controls all compressors to run at half load and distribute refrigerant to all heat exchangers to improve the overall efficiency of the system.

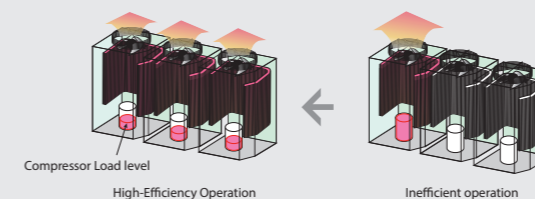

Heat exchanger refrigerant control

The efficiency of the upper and lower heat exchangers in the outdoor unit has been improved through optimal control of the refrigerant path.

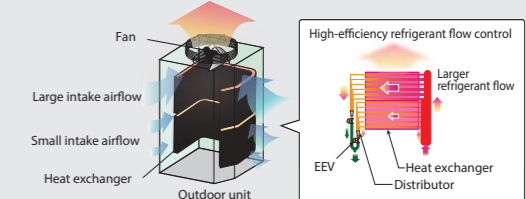

Outdoor units lineup • Combinations other than those listed below are not recommended.

Space saving combination

22.4 kW (8 HP) AJY072LALBH UNIT: AJY072LALBH	28.0 kW (10 HP) AJY090LALBH UNIT: AJY090LALBH	33.5 kW (12 HP) AJY108LALBH UNIT: AJY108LALBH	40.0 kW (14 HP) AJY126LALBH UNIT: AJY126LALBH	45.0 kW (16 HP) AJY144LALBH UNIT: AJY144LALBH
50.0 kW (18 HP) AJY162LALBH UNIT: AJY162LALBH	56.0 kW (20 HP) AJY180LALBH UNIT: AJY090/090LALBH	62.4 kW (22 HP) AJY198LALBH UNIT: AJY126/072LALBH	68.0 kW (24 HP) AJY216LALBH UNIT: AJY126/090LALBH	73.0 kW (26 HP) AJY234LALBH UNIT: AJY144/090LALBH
78.0 kW (28 HP) AJY252LALBH UNIT: AJY162/090LALBH	85.0 kW (30 HP) AJY270LALBH UNIT: AJY144/126LALBH	90.0 kW (32 HP) AJY288LALBH UNIT: AJY144/144LALBH	95.0 kW (34 HP) AJY306LALBH UNIT: AJY162/144LALBH	100.0 kW (36 HP) AJY324LALBH UNIT: AJY162/162LALBH
106.0 kW (38 HP) AJY342LALBH UNIT: AJY162/090/090LALBH	113.0 kW (40 HP) AJY360LALBH UNIT: AJY144/126/090LALBH	118.0 kW (42 HP) AJY378LALBH UNIT: AJY144/144/090LALBH	123.0 kW (44 HP) AJY396LALBH UNIT: AJY162/144/090LALBH	128.0 kW (46 HP) AJY414LALBH UNIT: AJY162/162/090LALBH
135.0 kW (48 HP) AJY432LALBH UNIT: AJY144/144/144LALBH	140.0 kW (50 HP) AJY450LALBH UNIT: AJY162/144/144LALBH	145.0 kW (52 HP) AJY468LALBH UNIT: AJY162/162/144LALBH	150.0 kW (54 HP) AJY486LALBH UNIT: AJY162/162/162LALBH	

Energy efficiency combination

44.8 kW (16 HP) AJY144LALBHH UNIT: AJY072/072LALBH	50.4 kW (18 HP) AJY162LALBHH UNIT: AJY090/072LALBH	55.9 kW (20 HP) AJY180LALBHH UNIT: AJY108/072LALBH	67.2 kW (24 HP) AJY216LALBHH UNIT: AJY072/072/072LALBH	72.8 kW (26 HP) AJY234LALBHH UNIT: AJY090/072/072LALBH
78.3 kW (28 HP) AJY252LALBHH UNIT: AJY108/072/072LALBH	84.8 kW (30 HP) AJY270LALBHH UNIT: AJY126/072/072LALBH	89.4 kW (32 HP) AJY288LALBHH UNIT: AJY108/108/072LALBH	95.9 kW (34 HP) AJY306LALBHH UNIT: AJY126/108/072LALBH	100.5 kW (36 HP) AJY324LALBHH UNIT: AJY108/108/108LALBH
107.0 kW (38 HP) AJY342LALBHH UNIT: AJY126/108/108LALBH	113.5 kW (40 HP) AJY360LALBHH UNIT: AJY126/126/108LALBH	120.0 kW (42 HP) AJY378LALBHH UNIT: AJY126/126/126LALBH	125.0 kW (44 HP) AJY396LALBHH UNIT: AJY144/126/108LALBH	130.0 kW (46 HP) AJY414LALBHH UNIT: AJY144/144/126LALBH

8, 10 HP: AJY072LALBH/AJY090LALBH
12, 14, 16, 18 HP: AJY108LALBH/AJY126LALBH/AJY144LALBH/AJY162LALBH



8, 10 HP

12, 14, 16, 18 HP

Dimensions

(Unit: mm)

8, 10 HP

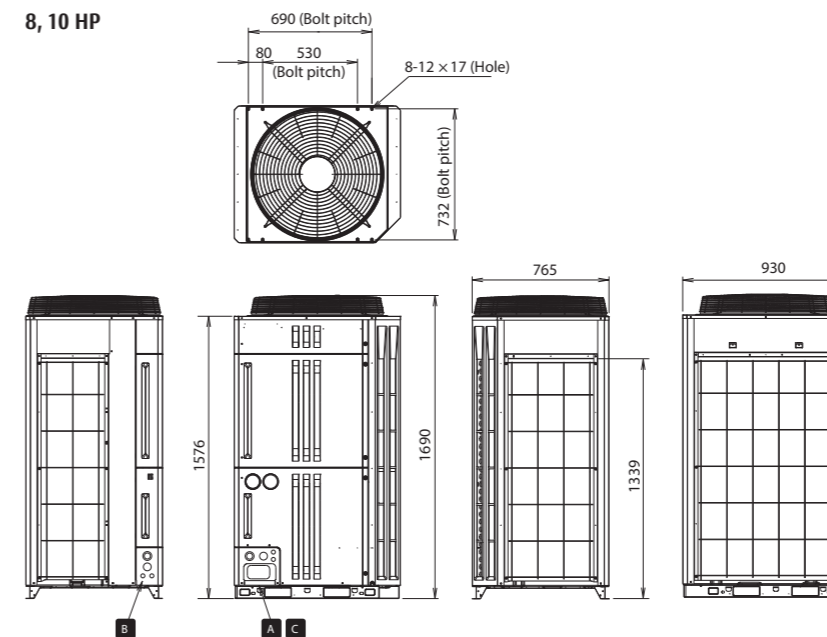

12, 14, 16, 18 HP

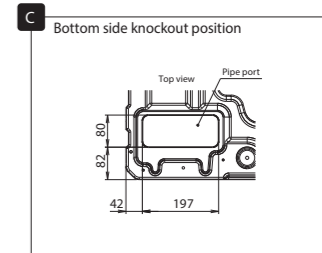
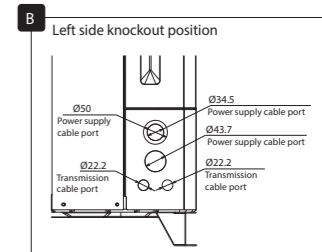
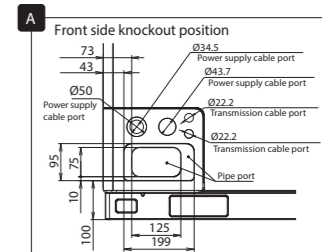
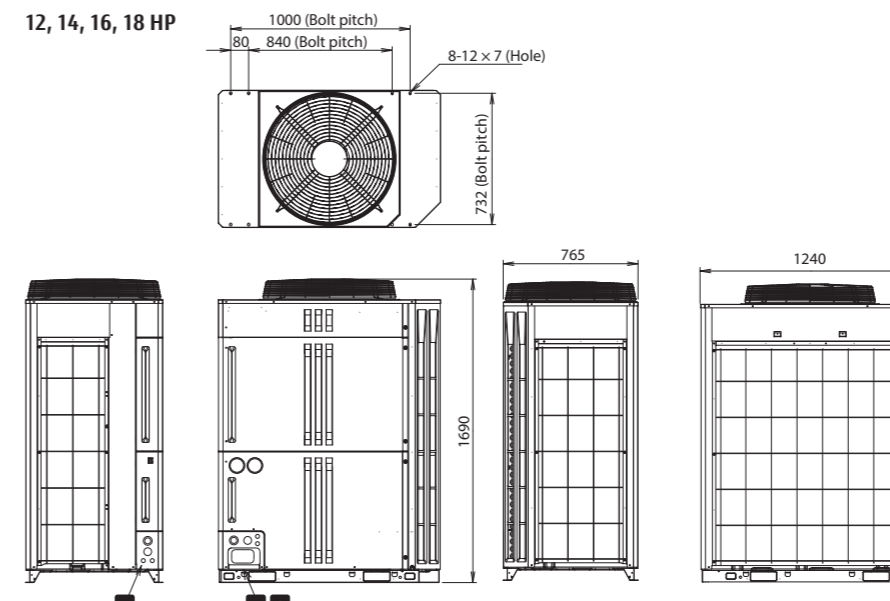

Heat Pump

Modular Type



System configuration example

- Suitable for air conditioning midsize and large buildings. Connecting each outdoor unit to create a high-capacity system
- Multiple indoor units are connected with separation tubes and headers.

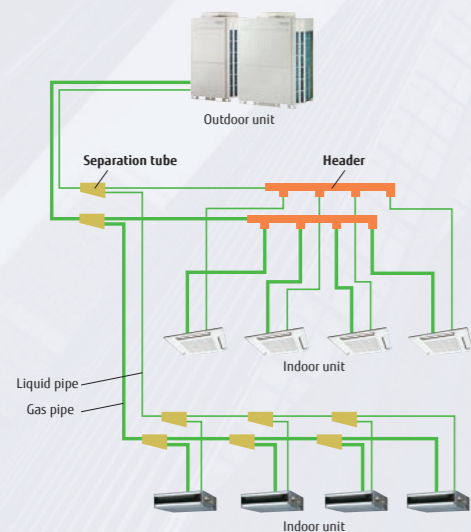

FUJITSU GENERAL (Euro) GmbH participates in the ECP program for VRF. Check ongoing validity of certificate: www.eurovent-certification.com

Efficiency in actual operating conditions

Class-leading high COP (Maximum) The use of our proprietary heat exchanger structure and high-efficiency DC twin-rotary compressors achieves the class-leading coefficient of performance (COP) in every combination.

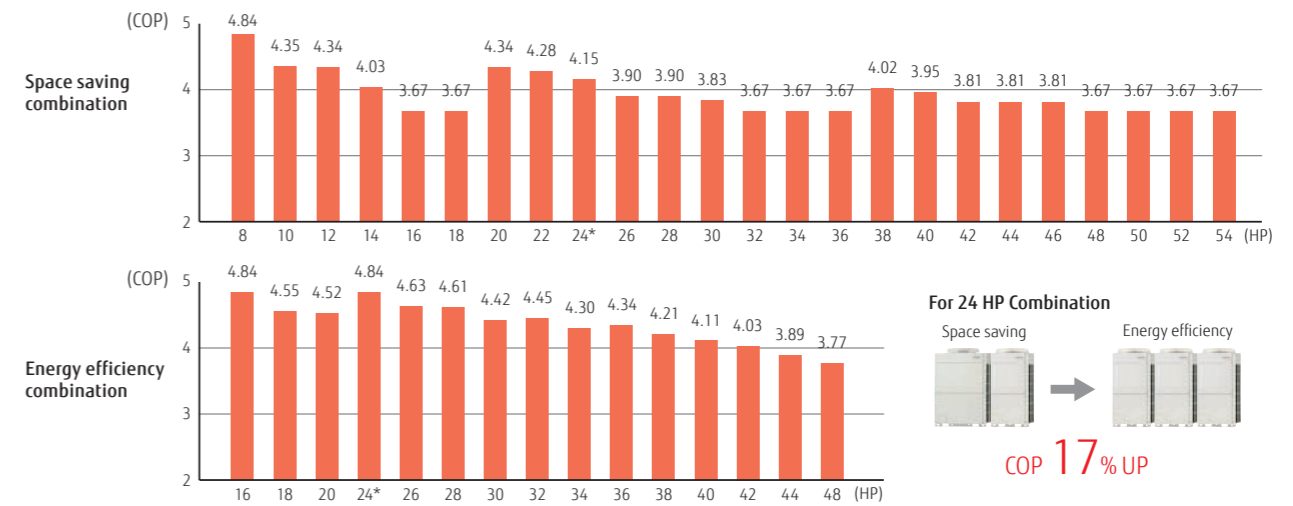

* These specifications are determined by ducted combination.
* Multiple outdoor units are not certified by Eurovent.

Elaborate anti-corrosion treatment

Anti-corrosion coated casings

Satisfies the JRA* regulation for anti-corrosion treatment (JRA 4002).
*JRA: Japan Refrigeration Association

PCB and electronic components

High-ambient-temperature compatible electronic components are used. Silicon coating is applied to all PCB circuits for corrosion protection.



High-ambient-temperature compatible and corrosion resistant

PCB components
Applicable to PCB components and refrigeration cycle components

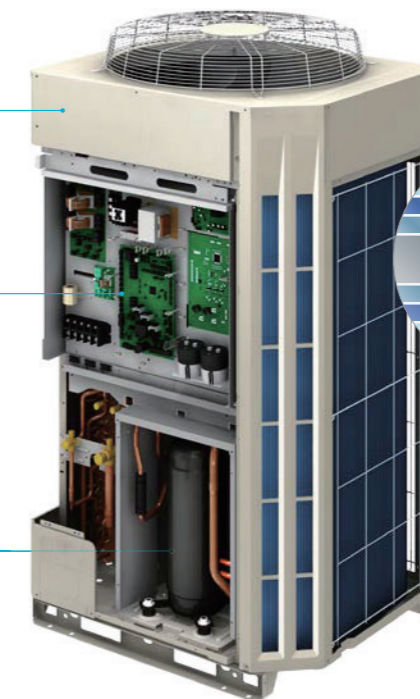

Blue fin heat exchanger

- Hydrophilic coating
- Cobalt Blue protection
- Standard chromate protection
- Aluminium base materials

Screws and hinges

Zinc-chrome-acid film treatment applied to all screws and hinges.



High ambient operation design

The DC fan motor, large propeller fan, and large heat exchanger enable cooling in outside temperatures of up to 52°C.

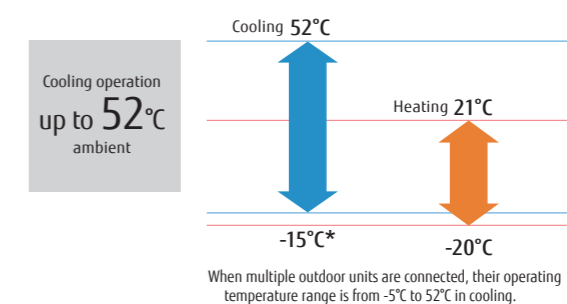

Outdoor units lineup • Combinations other than those listed below are not recommended.

Space saving combination

22.4 kW (8 HP) AJY072LNLBH UNIT: AJY072LNLBH	28.0 kW (10 HP) AJY090LNLBH UNIT: AJY090LNLBH	33.5 kW (12 HP) AJY108LNLBH UNIT: AJY108LNLBH	40.0 kW (14 HP) AJY126LNLBH UNIT: AJY126LNLBH	45.0 kW (16 HP) AJY144LNLBH UNIT: AJY144LNLBH
50.0 kW (18 HP) AJY162LNLBH UNIT: AJY162LNLBH	56.0 kW (20 HP) AJY180LNLBH UNIT: AJY090/090LNLBH	62.4 kW (22 HP) AJY198LNLBH UNIT: AJY126/072LNLBH	68.0 kW (24 HP) AJY216LNLBH UNIT: AJY126/090LNLBH	73.0 kW (26 HP) AJY234LNLBH UNIT: AJY144/090LNLBH
78.0 kW (28 HP) AJY252LNLBH UNIT: AJY162/090LNLBH	85.0 kW (30 HP) AJY270LNLBH UNIT: AJY144/126LNLBH	90.0 kW (32 HP) AJY288LNLBH UNIT: AJY144/144LNLBH	95.0 kW (34 HP) AJY306LNLBH UNIT: AJY162/144LNLBH	100.0 kW (36 HP) AJY324LNLBH UNIT: AJY162/162LNLBH
106.0 kW (38 HP) AJY342LNLBH UNIT: AJY162/090/090LNLBH	113.0 kW (40 HP) AJY360LNLBH UNIT: AJY144/126/090LNLBH	118.0 kW (42 HP) AJY378LNLBH UNIT: AJY144/144/090LNLBH	123.0 kW (44 HP) AJY396LNLBH UNIT: AJY162/144/090LNLBH	128.0 kW (46 HP) AJY414LNLBH UNIT: AJY162/162/090LNLBH
135.0 kW (48 HP) AJY432LNLBH UNIT: AJY144/144/144LNLBH	140.0 kW (50 HP) AJY450LNLBH UNIT: AJY162/144/144LNLBH	145.0 kW (52 HP) AJY468LNLBH UNIT: AJY162/162/144LNLBH	150.0 kW (54 HP) AJY486LNLBH UNIT: AJY162/162/162LNLBH	

Energy efficiency combination

44.8 kW (16 HP) AJY144LNLBHH UNIT: AJY072/072LNLBH	50.4 kW (18 HP) AJY162LNLBHH UNIT: AJY090/072LNLBH	55.9 kW (20 HP) AJY180LNLBHH UNIT: AJY108/072LNLBH	67.2 kW (24 HP) AJY216LNLBHH UNIT: AJY072/072/072LNLBH	72.8 kW (26 HP) AJY234LNLBHH UNIT: AJY090/072/072LNLBH
78.3 kW (28 HP) AJY252LNLBHH UNIT: AJY108/072/072LNLBH	84.8 kW (30 HP) AJY270LNLBHH UNIT: AJY126/072/072LNLBH	89.4 kW (32 HP) AJY288LNLBHH UNIT: AJY108/108/072LNLBH	95.9 kW (34 HP) AJY306LNLBHH UNIT: AJY126/108/072LNLBH	100.5 kW (36 HP) AJY324LNLBHH UNIT: AJY108/108/108LNLBH
107.0 kW (38 HP) AJY342LNLBHH UNIT: AJY126/108/108LNLBH	113.5 kW (40 HP) AJY360LNLBHH UNIT: AJY126/126/108LNLBH	120.0 kW (42 HP) AJY378LNLBHH UNIT: AJY126/126/126LNLBH	125.0 kW (44 HP) AJY396LNLBHH UNIT: AJY144/126/126LNLBH	130.0 kW (46 HP) AJY414LNLBHH UNIT: AJY144/144/126LNLBH

8, 10 HP: AJY072LNLBH/AJY090LNLBH
12, 14, 16, 18 HP: AJY108LNLBH/AJY126LNLBH/AJY144LNLBH/AJY162LNLBH



8, 10 HP

12, 14, 16, 18 HP

Dimensions

(Unit: mm)

8, 10 HP

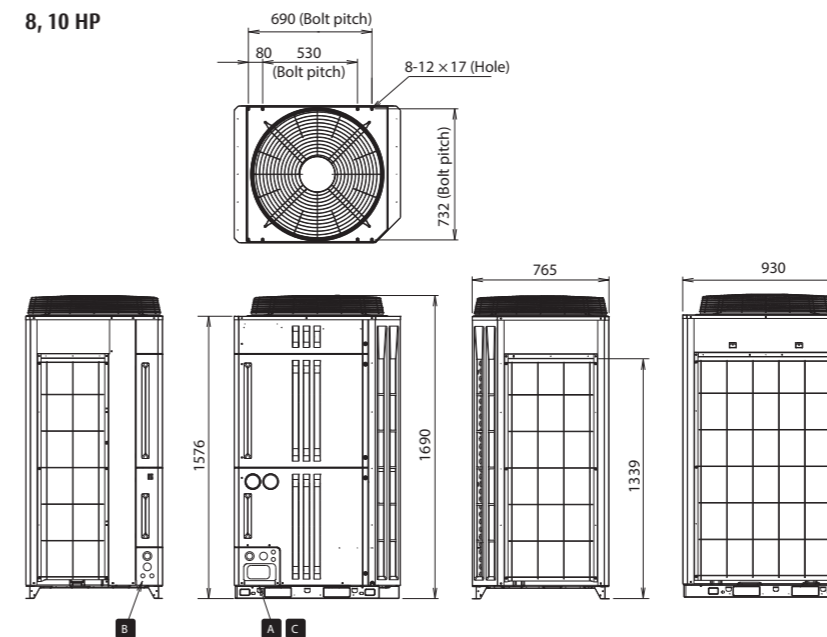

12, 14, 16, 18 HP

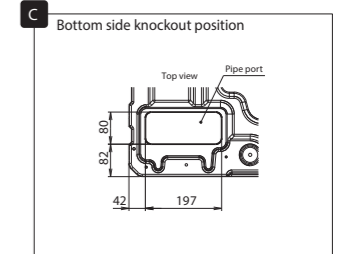
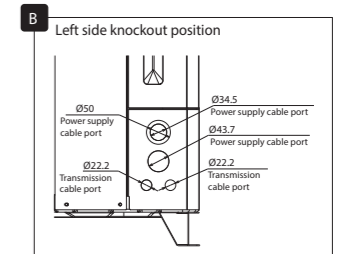
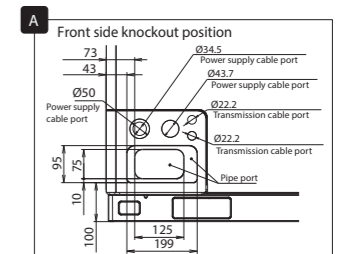
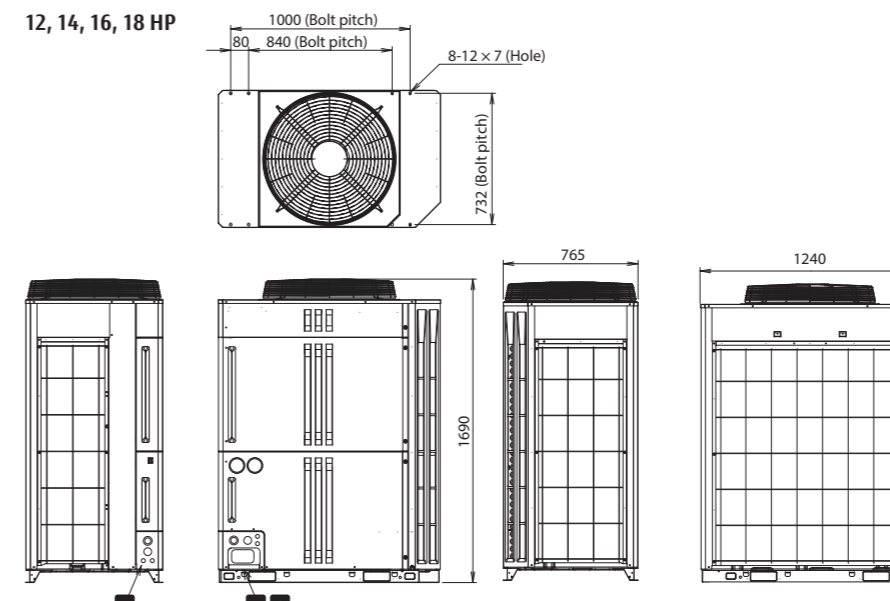

For more information, contact Fujitsu General Limited. (www.fujitsu-general.com)

Outdoor unit specifications

Space saving combination

Rated capacity range		HP	8	10	12	14	16	18	20	22	24	26	28	30	32	34	36	38	40	42	44	46	48	50	52	54
Model name			AJY072LNLBH	AJY090LNLBH	AJY108LNLBH	AJY126LNLBH	AJY144LNLBH	AJY162LNLBH	AJY180LNLBH	AJY198LNLBH	AJY216LNLBH	AJY234LNLBH	AJY252LNLBH	AJY270LNLBH	AJY288LNLBH	AJY306LNLBH	AJY324LNLBH	AJY342LNLBH	AJY360LNLBH	AJY378LNLBH	AJY396LNLBH	AJY414LNLBH	AJY432LNLBH	AJY450LNLBH	AJY468LNLBH	AJY486LNLBH
Unit 1			AJY072LNLBH	AJY090LNLBH	AJY108LNLBH	AJY126LNLBH	AJY144LNLBH	AJY162LNLBH	AJY180LNLBH	AJY198LNLBH	AJY216LNLBH	AJY234LNLBH	AJY252LNLBH	AJY270LNLBH	AJY288LNLBH	AJY306LNLBH	AJY324LNLBH	AJY342LNLBH	AJY360LNLBH	AJY378LNLBH	AJY396LNLBH	AJY414LNLBH	AJY432LNLBH	AJY450LNLBH	AJY468LNLBH	AJY486LNLBH
Unit 2			AJY072LNLBH	AJY090LNLBH	AJY108LNLBH	AJY126LNLBH	AJY144LNLBH	AJY162LNLBH	AJY180LNLBH	AJY198LNLBH	AJY216LNLBH	AJY234LNLBH	AJY252LNLBH	AJY270LNLBH	AJY288LNLBH	AJY306LNLBH	AJY324LNLBH	AJY342LNLBH	AJY360LNLBH	AJY378LNLBH	AJY396LNLBH	AJY414LNLBH	AJY432LNLBH	AJY450LNLBH	AJY468LNLBH	AJY486LNLBH
Unit 3			AJY072LNLBH	AJY090LNLBH	AJY108LNLBH	AJY126LNLBH	AJY144LNLBH	AJY162LNLBH	AJY180LNLBH	AJY198LNLBH	AJY216LNLBH	AJY234LNLBH	AJY252LNLBH	AJY270LNLBH	AJY288LNLBH	AJY306LNLBH	AJY324LNLBH	AJY342LNLBH	AJY360LNLBH	AJY378LNLBH	AJY396LNLBH	AJY414LNLBH	AJY432LNLBH	AJY450LNLBH	AJY468LNLBH	AJY486LNLBH
Maximum connectable indoor units			13	16	19	23	26	29	33	36	40	43	46	50	53	55	55	55	55	55	55	55	55	55	55	55
Connectable capacity range of indoor units		Cooling	11.2-29.1	14-36.4	16.8-43.5	20-52	22.5-58.5	25-65	28-72.8	31.2-81.1	34-88.4	36.5-94.9	39-101.4	42.5-110.5	45-117	47.5-123.5	50-130	53-137.8	56.5-146.9	59-153.4	61.5-159.9	64-166.4	67.5-175.5	70-182	72.5-188.5	75-195
Power source			3-phase, 4-wire, ~400 V, 50 Hz												3-phase, 4-wire, ~400 V, 50 Hz											
T1 condition	Capacity	Cooling	kW																							
		Nominal Heating	kW																							
		Max. Heating	kW																							
	Input power	Cooling	Btu/h																							
		Nominal Heating	Btu/h																							
		Max. Heating	Btu/h																							
	Current	Cooling	A																							
		Nominal Heating	A																							
		Max. Heating	A																							
	EER	Cooling	W/W																							
Nominal Heating		W/W																								
Max. Heating		W/W																								
COP	Cooling	Btu/h/W																								
	Nominal Heating	Btu/h/W																								
	Max. Heating	Btu/h/W																								
T3 condition	Capacity	Cooling	kW																							
		Nominal Heating	kW																							
		Max. Heating	kW																							
Input power	Cooling	Btu/h																								
	Nominal Heating	Btu/h																								
	Max. Heating	Btu/h																								
EER	Cooling	W/W																								
	Nominal Heating	W/W																								
	Max. Heating	W/W																								
COP	Cooling	Btu/h/W																								
	Nominal Heating	Btu/h/W																								
	Max. Heating	Btu/h/W																								
Power factor		%																								
Airflow rate		High	m ³ /h																							
Sound pressure level/Power level		Cooling	dB(A)																							
Max. External static pressure		Pa																								
Compressor motor output		kW																								
Heat exchanger fin			Blue fin																							
Net Dimensions	Height	mm																								
	Width	mm																								
	Depth	mm																								
Weight		kg																								
Refrigerant		Type (Global Warming Potential)	R410A (2,088)																							
Charge		kg (CO ₂ eq-T)																								
Connection pipe diameter		Liquid	mm																							
		Gas	mm																							
Operating Range		Cooling	°CDB																							
		Heating	°CDB																							

Energy Efficiency Combination

Rated capacity range		HP	16	18	20	24	26	28	30	32	34	36	38	40	42	44	46	
Model name			AJY144LNLBHH	AJY162LNLBHH	AJY180LNLBHH	AJY216LNLBHH	AJY234LNLBHH	AJY252LNLBHH	AJY270LNLBHH	AJY288LNLBHH	AJY306LNLBHH	AJY324LNLBHH	AJY342LNLBHH	AJY360LNLBHH	AJY378LNLBHH	AJY396LNLBHH	AJY414LNLBHH	
Unit 1			AJY144LNLBHH	AJY162LNLBHH	AJY180LNLBHH	AJY216LNLBHH	AJY234LNLBHH	AJY252LNLBHH	AJY270LNLBHH	AJY288LNLBHH	AJY306LNLBHH	AJY324LNLBHH	AJY342LNLBHH	AJY360LNLBHH	AJY378LNLBHH	AJY396LNLBHH	AJY414LNLBHH	
Unit 2			AJY144LNLBHH	AJY162LNLBHH	AJY180LNLBHH	AJY216LNLBHH	AJY234LNLBHH	AJY252LNLBHH	AJY270LNLBHH	AJY288LNLBHH	AJY306LNLBHH	AJY324LNLBHH	AJY342LNLBHH	AJY360LNLBHH	AJY378LNLBHH	AJY396LNLBHH	AJY414LNLBHH	
Unit 3			AJY144LNLBHH	AJY162LNLBHH	AJY180LNLBHH	AJY216LNLBHH	AJY234LNLBHH	AJY252LNLBHH	AJY270LNLBHH	AJY288LNLBHH	AJY306LNLBHH	AJY324LNLBHH	AJY342LNLBHH	AJY360LNLBHH	AJY378LNLBHH	AJY396LNLBHH	AJY414LNLBHH	
Maximum connectable indoor units			26	29	33	39	43	46	50	52	55	55	55	55	55	55	55	
Connectable capacity range of indoor units		Cooling	22.4-58.2	25.2-65.5	28-72.6	33.6-87.3	36.4-94.6	39.2-101.7	42.4-110.2	44.7-116.2	48-124.6	50.3-130.6	53.5-139.1	56.8-147.5	60-156	62.5-162.5	65-169	
Power source			3-phase, 4-wire, ~400 V, 50 Hz												3-phase, 4-wire, ~400 V, 50 Hz			
T1 condition	Capacity	Cooling	kW															
		Nominal Heating	kW															
		Max. Heating	kW															
	Input power	Cooling	Btu/h															
		Nominal Heating	Btu/h															
		Max. Heating	Btu/h															
	Current	Cooling	A															
		Nominal Heating	A															
		Max. Heating	A															
	EER	Cooling	W/W															
Nominal Heating		W/W																
Max. Heating		W/W																
COP	Cooling	Btu/h/W																
	Nominal Heating	Btu/h/W																
	Max. Heating	Btu/h/W																
T3 condition	Capacity	Cooling	kW															
		Nominal Heating	kW															
		Max. Heating	kW															
Input power	Cooling	Btu/h																
	Nominal Heating	Btu/h																
	Max. Heating	Btu/h																
EER	Cooling	W/W																
	Nominal Heating	W/W																
	Max. Heating	W/W																
Power factor		%																
Airflow rate		High	m ³ /h															
Sound pressure level/Power level		Cooling	dB(A)															
Max. External static pressure		Pa																
Compressor motor output		kW																
Heat exchanger fin			Blue fin															
Net Dimensions	Height	mm																
	Width	mm																
	Depth	mm																
Weight		kg																
Refrigerant		Type (Global Warming Potential)	R410A (2,088)															
Charge		kg (CO ₂ eq-T)																
Connection pipe diameter		Liquid	mm															
		Gas	mm															
Operating Range		Cooling	°CDB															
		Heating	°CDB															

Note: Specifications are based on the following conditions.

Cooling (T1): Indoor temperature of 27°CDB/19°CWB, and outdoor temperature of 35°CDB/24°CWB
 Cooling (T3): Indoor temperature of 29°CDB/19°CWB, and outdoor temperature of 46°CDB/24°CWB

Heating: Indoor temperature of 20°CDB/15°CWB, and outdoor temperature of 7°CDB/6°CWB.

Pipe length: 7.5 m Height difference between outdoor and indoor unit: 0 m.

* These specifications are determined by ducted combination.

* Multiple outdoor units are not certified by Eurovent.

VRF INDOOR UNITS

20 types and 97 models available to meet the requirements of any building design.

Indoor units for the AIRSTAGE™ VRF Systems are compact, highly efficient, quiet, and user-friendly. Fujitsu General offers a variety of types and capacities for its indoor units that are easy to install and maintain. In addition, a variety of optional parts are available to provide an even more desirable air conditioning experience to users.

- Vn-060 INDOOR UNITS LINEUP
- Vn-062 1-Way Flow Cassette
- Vn-064 3D Flow Cassette
- Vn-066 Compact Cassette (Grid type/Standard type)
- Vn-068 Cassette Slim type (Circular Flow/4-way Flow)
- Vn-072 Cassette Large type (Circular Flow/4-way Flow)
- Vn-076 Low Static Pressure Duct/Mini Duct
- Vn-078 Low Static Pressure Duct/Slim Duct/Slim Concealed Floor
- Vn-082 Medium Static Pressure Duct
- Vn-088 High Static Pressure Duct
- Vn-092 Compact Floor
- Vn-094 Floor/Ceiling
- Vn-096 Ceiling
- Vn-098 Wall-mounted (EEV Internal/external)



VRF Indoor Unit Lineup

Capacity range (kW)			1.1	2.2	2.8	3.6	4.0	4.5	5.6	7.1	9.0	10.0	11.2	12.5	14.0	18.0	22.4	25.0	28.0			
Class			4	7	9	12	14	14	18	24	30	34	36	45	54	60	72	90	96			
Cassette	Compact type	Compact Grid type/Standard type	AUXB 004 GLEH	AUXB 007 GLEH	AUXB 009 GLEH	AUXB 012 GLEH			AUXB 014 GLEH	AUXB 018 GLEH	AUXB 024 GLEH											
	Slim type	Circular Flow			AUXN 009 GLAH**6	AUXN 012 GLAH**6			AUXN 014 GLAH**6	AUXM 018 GLEH	AUXM 024 GLEH	AUXM 030 GLEH										
		4-way Flow								AUXD 18 GALH	AUXD 24 GALH											
	Large type	Circular Flow								AUXK 018 GLEH	AUXK 024 GLEH	AUXK 030 GLEH	AUXK 034 GLEH	AUXK 036 GLEH	AUXK 045 GLEH	AUXK 054 GLEH						
		4-way Flow								AUXA 18 GALH*2	AUXA 24 GALH*2	AUXA 30 GALH	AUXA 34 GALH	AUXA 36 GALH	AUXA 45 GALH	AUXA 54 GALH						
	One-way Flow type	One-way Flow	004 - 012 014 - 024	AUXV 004 GLEH	AUXV 007 GLEH	AUXV 009 GLEH	AUXV 012 GLEH			AUXV 014 GLEH	AUXV 018 GLEH	AUXV 024 GLEH										
3D Flow type	3D Flow								AUXS 018 GLEH	AUXS 024 GLEH												
Duct	Low Static Pressure Duct	Mini Duct (With drain pump)	004 - 014 018 024	ARXK 004 GLGH	ARXK 007 GLGH	ARXK 009 GLGH	ARXK 012 GLGH		ARXK 014 GLGH	ARXK 018 GLGH	ARXK 024 GLGH											
		Slim Duct (With drain pump)	04/007 - 014 018 024	ARXD 04 GALH*3	ARXD 007 GLEH	ARXD 009 GLEH	ARXD 012 GLEH		ARXD 014 GLEH	ARXD 018 GLEH	ARXD 024 GLEH											
		Slim Duct High-efficiency*6	009 - 014 018			ARXP 009 GLAH*5	ARXP 012 GLAH*5		ARXP 014 GLAH*5	ARXP 018 GLAH*7												
	Medium static pressure duct	Normal										ARXA 024 GLEH	ARXA 030 GLEH		ARXA 036 GLEH	ARXA 045 GLEH						
		High-efficiency*6								ARXQ 018 GTAH*2	ARXQ 024 GTAH*2											
		High-efficiency*6									ARXP 024 GTAH*7	ARXP 030 GTAH*7										
High Static Pressure Duct	Normal	036/45 - 60 072 - 090 096												ARXC 036 GTEH	ARXC 45 GATH		ARXC 60 GATH*1	ARXC 072 GTEH*1	ARXC 090 GTEH*1	ARXC 096 GTEH*1		
	High-efficiency*6										ARXQ 030 GTAH*2											
Floor	Floor (*Same as Ceiling models)						ABYA 012 GTEH		ABYA 014 GTEH	ABYA 018 GTEH	ABYA 024 GTEH											
	Slim Concealed Floor (*Same as Slim Duct models)	04/007 - 014 018 024	ARXD 04 GALH*3	ARXD 007 GLEH	ARXD 009 GLEH	ARXD 012 GLEH		ARXD 014 GLEH	ARXD 018 GLEH	ARXD 024 GLEH												
	Compact Floor		AGYA 004 GCGH	AGYA 007 GCGH	AGYA 009 GCGH	AGYA 012 GCGH		AGYA 014 GCGH														
	Compact Floor (EEV external)		AGYE 004 GCEH	AGYE 007 GCEH	AGYE 009 GCEH	AGYE 012 GCEH		AGYE 014 GCEH														
Ceiling		This model requires the EV kit to be connected.					ABYA 012 GTEH		ABYA 014 GTEH	ABYA 018 GTEH	ABYA 024 GTEH	ABYA 030 GTEH		ABYA 036 GTEH	ABYA 045 GTEH	ABYA 054 GTEH						
Wall-mounted type	Wall-mounted type	004 - 014 18 - 24 030 - 034	ASYA 004 GCGH	ASYA 007 GCGH	ASYA 009 GCGH	ASYA 012 GCGH		ASYA 014 GCGH		ASYA 18 GBCH	ASYA 24 GBCH	ASYA 030 GTEH	ASYA 034 GTEH									
	Wall-mounted type (EEV external)	004 - 014	ASYE 004 GCEH	ASYE 007 GCEH	ASYE 009 GCEH	ASYE 012 GCEH		ASYE 014 GCEH														
		This model requires the EV kit to be connected.																				

*1: ARXC60/072/090/096G cannot be connected to J-IVS/J-IV Series.
 *2: AUXA18/24GALH, ARXQ018/024/030GTAH type can be connected to VR-IV/V-III Series only.
 *3: ARXD04GALH cannot be connected to J-IVS/J-IV/J-IVL/VR-IV Series.
 *4: AUXN009/012/014GLAH can be connected to J-IVS/J-IV Series only.
 *5: ARXP009/012/014GLAH can be connected to J-IVS/J-IV/J-IVL Series only.
 *6: Production by order
 *7: ARXP018GLAH, ARXP024/030GTAH can be connected to J-IVL Series only. Specifications and design are subject to change without notice.

Cassette

One-way Flow type



Compact chassis size

The compact size allows easy installation in a variety of commercial facilities and environments.

- The height of the chassis is less than 200 mm for all models.
- All 4 to 12 kBTu models are less than 1,000 mm wide.
- The depth of the chassis is 570 mm, which fits nicely into a grid type ceiling.

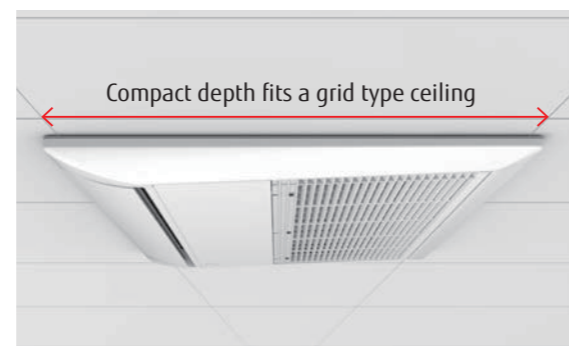

Dimensions (Panel size)		(Unit: mm)						
		4	7	9	12	14	18	24
H			198 (43)				198 (43)	
W			785 (950)				1,190 (1,360)	
D			570 (620)				570 (620)	

Wide airflow range

A large flap with a wide range of movements, equipped with louvers arranged triangularly, sends air into every corner of the room.



In cooling mode, the left/right airflow reaches every corner of the room without directly touching the human body to provide comfortable air conditioning.

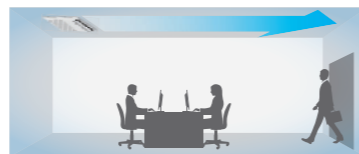

In heating mode, warm air is directed downward toward the floor to warm the feet and lower body, while the head is kept relatively cool.

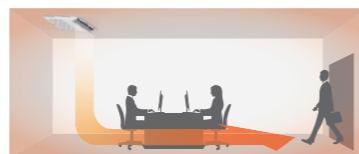

Note: This is a conceptual drawing. The performance of an air conditioner may vary depending on where it is installed, the size of the room, and its distance from the wall.

Quiet mode

The low operating noise makes the model ideal for use in hotel rooms.



Model: AUXV004GLEH/AUXV007GLEH/AUXV009GLEH
 AUXV012GLEH/AUXV014GLEH/AUXV018GLEH
 AUXV024GLEH



AUXV004/007/009/012GLEH



AUXV014/018/024GLEH

Specifications

Model name		AUXV004GLEH	AUXV007GLEH	AUXV009GLEH	AUXV012GLEH	AUXV014GLEH	AUXV018GLEH	AUXV024GLEH	
Power source		Single phase, ~230 V, 50 Hz							
Capacity	Cooling	1.1	2.2	2.8	3.6	4.5	5.6	7.1	
	Heating	1.3	2.8	3.2	4.0	5.0	6.3	8.0	
Input power		W	30/30	42/42	42/42	60/60	38/38	56/56	99/99
Airflow rate*	High	m ³ /h	460	550	550	670	720	890	1,150
	Med-High		440	440	440	520	660	840	1,020
	Med		420	420	420	480	630	770	940
	Med-Low		400	400	400	450	600	710	790
	Low		380	380	380	410	580	660	700
	Quiet		360	360	360	360	550	580	610
Sound pressure level*	High	dB(A)	38	42	42	45	37	44	49
	Med-High		37	37	37	41	36	43	47
	Med		36	36	36	39	35	40	45
	Med-Low		35	35	35	38	34	38	42
	Low		33	33	33	36	33	36	39
	Quiet		32	32	32	32	32	34	36
Net Dimensions (H × W × D)		mm	198 × 785 × 570	198 × 785 × 570	198 × 785 × 570	198 × 785 × 570	198 × 1,190 × 570	198 × 1,190 × 570	198 × 1,190 × 570
Weight		kg (lbs)	18 (40)	19 (42)	19 (42)	19 (42)	26 (57)	26 (57)	27 (60)
Connection pipe diameter	Liquid (Flare)	mm	6.35	6.35	6.35	6.35	6.35	6.35	9.52
	Gas (Flare)	mm	9.52	9.52	9.52	12.70	12.70	12.70	15.88
Drain Hose Diameter (I.D./O.D.)						25/32			
Cassette Grille	Model name		UTG-UNYA-W			UTG-UNYB-W			
	Net Dimensions (H × W × D)	mm	43 × 950 × 620			43 × 1,360 × 620			
	Weight	kg (lbs)	6.5 (14.5)			8.5 (18.0)			

Note: Specifications are subject to the following conditions:
 Cooling: Indoor temperature of 27°CDB/19°CWB, and outdoor temperature of 35°CDB/24°CWB.
 Heating: Indoor temperature of 20°CDB/15°CWB, and outdoor temperature of 7°CDB/6°CWB.
 Pipe length: 7.5 m; Height difference between outdoor unit and indoor unit: 0 m. Voltage: 230 [V]

Optional parts

- WLAN adapter: UTY-TFSXZ1
- IR Receiver Unit: UTY-TRHX
- Cassette Grille: UTG-UNYA-W/UTG-UNYB-W
- External power supply unit: UTZ-GXXA

Flexible Installation

The L-shaped pipe kit allows for more flexible installation. Equipped with a built-in drain pump as standard, which enables a maximum pipe height difference of 700 m from the ceiling.

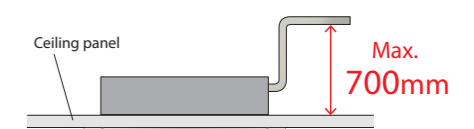

Dimensions

(Unit: mm)

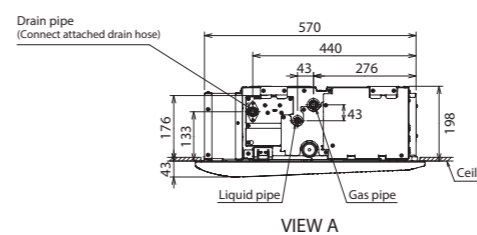
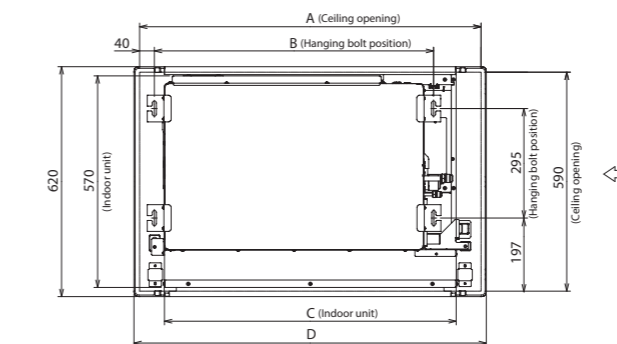

	AUXV004-012	AUXV014-024
A	920	1,330
B	752	1,152
C	785	1,190
D	950	1,360

3D Flow Cassette



3 individually controlled air outlet ports

The Comfortable airflow setting enables the left and right air outlet ports as well as the wide center port to work together to provide a comfortable room environment.

Temperature distribution during cooling and heating (when set to Comfortable airflow)



Testing conditions: Model AUXS024GLEH running cooling operation with the air volume set to "Hi" to maintain the room temperature at 18°C with the outdoor temperature at 35°C, tested in our 40m² environmental test room

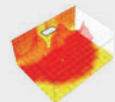

Testing conditions: Model AUXS024GLEH running heating operation with the air volume set to "Hi" to maintain the room temperature at 30°C with the outdoor temperature at 7°C, tested in our 40m² environmental test room

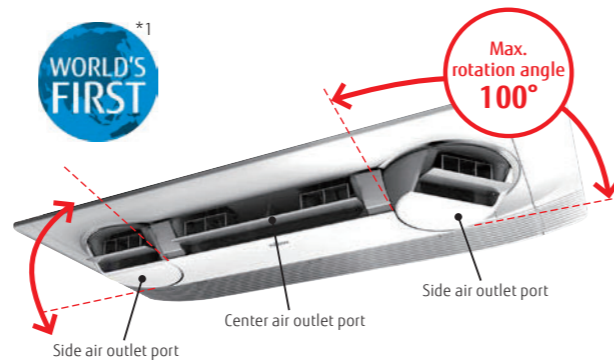

*1: Announced 2018. In the category of room air conditioners for the home (source: Fujitsu General Limited).

Individual airflow setting

The individual airflow setting function optimizes the airflow direction to match the room layout.

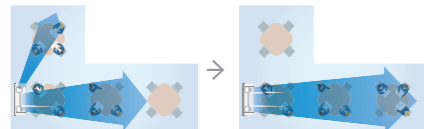

Adjusts airflows from the side air outlet ports to match the layout and usage of the room to minimize the amount of wasted airflow.



The airflow is optimally controlled to provide improved comfort in a narrow room.

Individual control of air outlet ports

Individual airflow can be set using a Wired remote controller with touch panel and Central remote controller*. The airflow from each air outlet port can be set individually.



Wired remote controller with Touch Panel
UTY-RNRYZ5



Central remote controller
UTY-DCGYZ2

* Feature available only on UTY-RNRYZ5 Wired remote controller with touch panel and UTY-DCGYZ2 Central remote controller

High Energy Saving

The structural design to take in a larger volume of air and blow air out more smoothly reduces air blowing loss and achieves class-leading energy-saving performance.

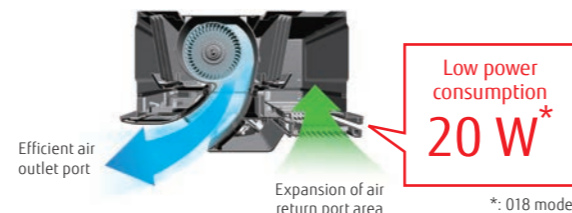

*: 018 model

Model: AUXS018GLEH/AUXS024GLEH



Specifications

Model name		AUXS018GLEH		AUXS024GLEH	
Power source		Single phase, ~230 V, 50 Hz			
Capacity	Cooling	5.60		7.10	
	Heating	6.30		8.00	
Input power		20/28		34/43	
Airflow rate*	High	750/870		950/1,040	
	Med-High	710/830		890/990	
	Med	690/780		860/930	
	Med-Low	660/740		810/880	
	Low	630/700		770/840	
	Quiet	540/540		540/540	
Sound pressure level*	High	38/41		43/46	
	Med-High	36/40		42/45	
	Med	35/39		41/43	
	Med-Low	35/37		40/42	
	Low	33/36		38/40	
	Quiet	29/29		29/29	
Net Dimensions (H × W × D)		mm 200 × 1,240 × 500		mm 200 × 1,240 × 500	
Weight		kg (lbs) 25 (55)		kg (lbs) 25 (55)	
Connection pipe diameter	Liquid (Flare)	6.35		9.52	
	Gas (Flare)	12.70		15.88	
Drain Hose Diameter (I.D./O.D.)				25/32	
Cassette Grille	Model name			UTG-USYA-W	
	Net Dimensions (H × W × D)	mm 85 × 1,350 × 580		mm 85 × 1,350 × 580	
Weight		kg (lbs) 11.5 (25)		kg (lbs) 11.5 (25)	

Note: Specifications are subject to the following conditions:
Cooling: Indoor temperature of 27°CDB/19°CWB, and outdoor temperature of 35°CDB/24°CWB.
Heating: Indoor temperature of 20°CDB/15°CWB, and outdoor temperature of 7°CDB/6°CWB.
Pipe length: 7.5 m; Height difference between outdoor unit and indoor unit: 0 m. Voltage: 230 [V]
*: Applicable to cooling and heating operation

Optional parts

- WLAN adapter: UTY-TFSXZ1
- IR Receiver Unit: UTY-TRHX
- Cassette Grille: UTG-USYA-W
- External power supply unit: UTZ-GXXA

Dimensions

(Unit: mm)

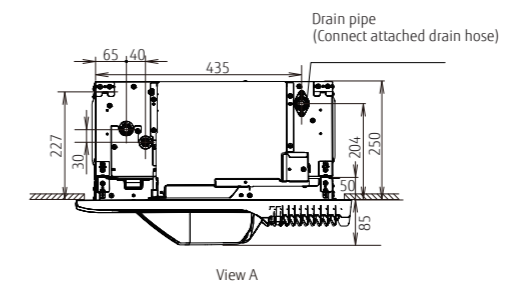
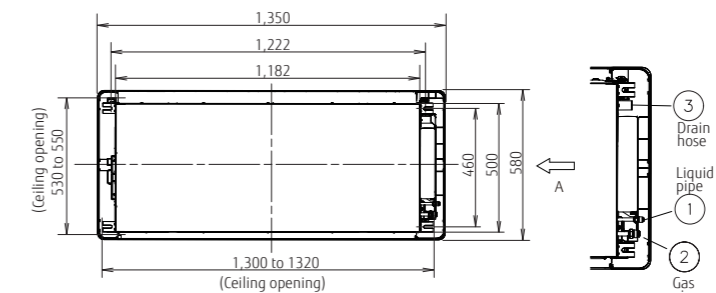

Compact Cassette Grid type



Compact and stylish panel

The compact and stylish panel fits nicely into a grid type ceiling. The linear design is a perfect fit into a grid of 620 mm × 620 mm in the ceiling.

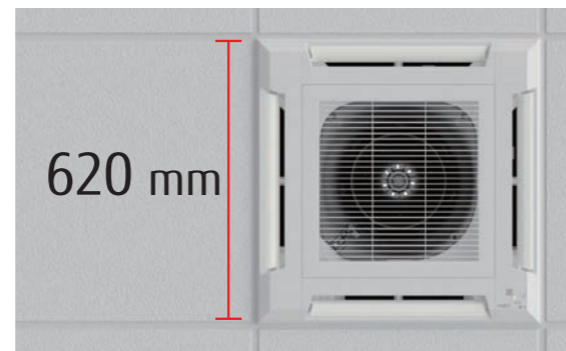

Easy maintenance

You can access the unit for maintenance just by removing a ceiling panel right next to the grille. As no inspection hole needs to be cut through the ceiling, no additional construction cost is incurred.



The air inlet grille can be installed to open in any direction for easy maintenance.



Flexible installation

The unit fits nicely into the decor of a grid type ceiling and can be installed near a lighting or a ventilation opening.



High ceiling mode

The cassette can be installed up to a height of 3.0 m. (012/014/018/024).

Model code	Maximum height from floor to ceiling (m)	
	Standard mode	High ceiling mode
004	2.7	-
007	2.7	-
009	2.7	-
012	2.7	3.0
014	2.7	3.0
018	2.7	3.0
024	2.7	3.0

Model: AUXB004GLEH/AUXB007GLEH/AUXB009GLEH
AUXB012GLEH/AUXB014GLEH/AUXB018GLEH
AUXB024GLEH



Specifications

Model name		AUXB004GLEH	AUXB007GLEH	AUXB009GLEH	AUXB012GLEH	AUXB014GLEH	AUXB018GLEH	AUXB024GLEH
Power source		Single phase, ~230 V, 50 Hz						
Capacity	Cooling	1.1	2.2	2.8	3.6	4.5	5.6	7.1
	Heating	1.3	2.8	3.2	4.1	5.0	6.3	8.0
Input power		23	25	25	29	35	36	84
Airflow rate	High	530/530	540	550	600	680	710	1,030
	Med-High	490/480	500	520	560	620	660	910
	Med	450/430	460	480	520	560	590	790
	Med-Low	420/380	420	440	480	500	520	680
	Low	390/340	390	400	430	440	460	560
Quiet		350/300	350	350	390	390	400	450
Sound pressure level	High	34/34	34	35	37	38	41	50
	Med-High	32/31	32	33	34	37	39	46
	Med	30/29	30	31	33	34	36	43
	Med-Low	28/26	28	29	31	32	33	39
	Low	27/24	27	27	29	30	30	35
Quiet		25/21	25	25	27	27	27	30
Net Dimensions (H × W × D)		mm 245 × 570 × 570	245 × 570 × 570	245 × 570 × 570	245 × 570 × 570	245 × 570 × 570	245 × 570 × 570	245 × 570 × 570
Weight		kg (lbs) 14.5 (32)	15 (33)	15 (33)	15 (33)	15 (33)	17 (37)	17 (37)
Connection pipe diameter	Liquid (Flare)	6.35	6.35	6.35	6.35	6.35	6.35	9.52
	Gas (Flare)	9.52	9.52	9.52	12.70	12.70	12.70	15.88
Drain Hose Diameter (I.D./O.D.)		25/32						
Cassette Grille		Model name: UTG-UFYE-W/UTG-UFYC-W						
Net Dimensions (H × W × D)		mm 50 × 620 × 620/50 × 700 × 700						
Weight		kg (lbs) 2.3 (5.1)/2.6 (6)						

Note: Specifications are subject to the following conditions:
Cooling: Indoor temperature of 27°CDB/19°CWB, and outdoor temperature of 35°CDB/24°CWB.
Heating: Indoor temperature of 20°CDB/15°CWB, and outdoor temperature of 7°CDB/6°CWB.
Pipe length: 7.5 m; Height difference between outdoor unit and indoor unit: 0 m. Voltage: 230 [V]
*1: This value is under cooling operation.

Optional parts

Air Outlet Shutter Plate:	UTR-YDZB	Cassette Grille:	UTG-UFYC-W, UTG-UFYE-W
Fresh Air Intake Kit:	UTZ-VXAA	External power supply unit:	UTZ-GXXA
Insulation kit for high humidity:	UTZ-KXGC	WLAN adapter:	UTY-TFSXZ1
Silver Ion Filter:	UTD-HFAA		

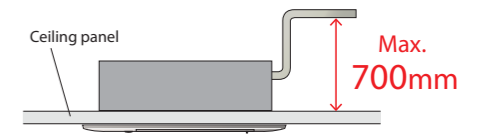

Dimensions

(Unit: mm)

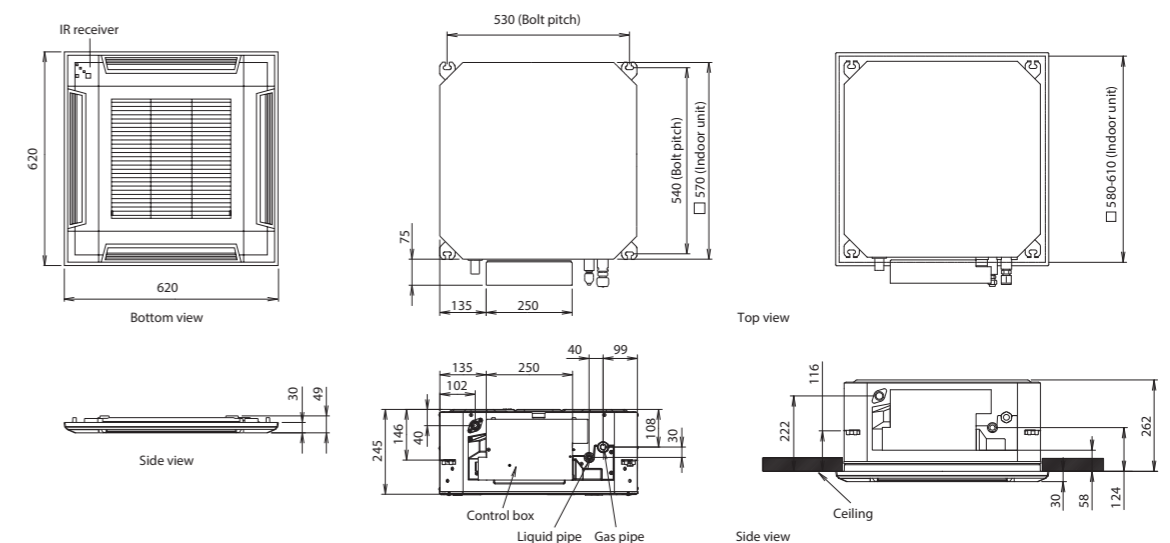

Cassette Slim type Circular Flow



Unique Circular Flow design

This Cassette type air conditioner is equipped with a high performance DC fan motor, a turbo fan, and a louver to propel powerful airflows in all directions.

- Ø7 mm high-density heat exchanger
- New DC fan motor
- High-efficiency turbo fan
- Seamless airflow louver

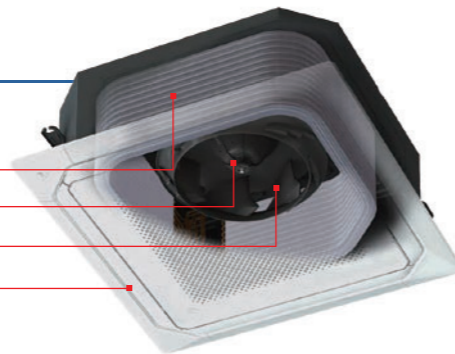

Uniform temperature air conditioning

Achieve a comfortable air conditioning spread to every corner of the room thanks to the circular flow and wide vertical airflow.

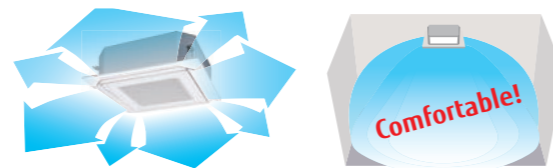

Individual louver control

Each louver can be set individually by the Touch panel wired remote controller so the user can enjoy the comfort of different directional airflows according to the room layout.

* UTY-RNRYZ5 Wired remote controller with touch panel and
UTY-DCGYZ2 Central remote controller only



Comfortable air conditioning by preventing direct blowing of cold air and by providing swinging air flow simultaneously.

Provides efficient air conditioning based on the room layout

The human sensor contributes to further energy savings.

Energy saving operation starts automatically by detecting the motion of a person. Two modes of save operation mode and stop mode can be selected.

* UTY-RNRYZ5 Wired remote controller with touch panel and
UTY-DCGYZ2 Central remote controller only



Human sensor (Optional)

- 2 modes are available to choose from:
- Auto economy mode** The air conditioner switches to operate on reduced power when it detects that the room is unoccupied.
 - Auto-off mode** The air conditioner stops operating when it detects that the room is unoccupied.

Model: AUXN009GLAH*/AUXN012GLAH*/AUXN014GLAH* * AUXN**GLAH: Production by order
AUXM018GLEH/AUXM024GLEH/AUXM030GLEH



Specifications

Model name	AUXN009GLAH*	AUXN012GLAH*	AUXN014GLAH*	AUXM018GLEH	AUXM024GLEH	AUXM030GLEH		
Power source	Single phase, ~230 V, 50 Hz							
Capacity	Cooling	2.8	3.6	4.5	5.6	7.1	9.0	
	Heating	3.2	4.0	5.0	6.3	8.0	10.0	
Input power	W	20	20	20	20	25	49	
Airflow rate	High	1,050	1,050	1,050	1,050	1,120	1,470	
	Med-High	930	930	930	930	1,050	1,160	
	Med	900	900	900	900	930	1,070	
	Med-Low	870	870	870	870	900	930	
	Low	810	810	810	810	870	900	
	Quiet	780	780	780	780	780	780	
Sound pressure level	High	33	33	33	33	35	40	
	Med-High	32	32	32	32	33	36	
	Med	31	31	31	31	32	34	
	Med-Low	30	30	30	30	31	32	
	Low	29	29	29	29	30	31	
	Quiet	28	28	28	28	28	28	
Dimensions (H × W × D)	mm	246 × 840 × 840						
Weight	kg (lbs)	24.5 (54)	24.5 (54)	24.5 (54)	24.0 (53)	24.5 (54)	24.5 (54)	
Connection pipe diameter	Liquid (Flare)	6.35	6.35	6.35	6.35	9.52	9.52	
	Gas (Flare)	12.70	12.70	12.70	12.70	15.88	15.88	
Drain Hose Diameter (I.D./O.D.)		25/32						
Cassette Grille	Model name	UTG-UKYC-W/UTG-UKYA-B						
	Dimensions (H × W × D)	mm	53 × 950 × 950					
	Weight	kg (lbs)	6.0 (13)					

Note: Specifications are subject to the following conditions:

Cooling: Indoor temperature of 27°CDB/19°CWB, and outdoor temperature of 35°CDB/24°CWB.

Heating: Indoor temperature of 20°CDB/15°CWB, and outdoor temperature of 7°CDB/6°CWB.

Pipe length: 7.5 m; Height difference between outdoor unit and indoor unit: 0 m. Voltage: 230 [V].

When AUX*018GLEH is connected to an outdoor unit other than one of the J-IVL Series, the pipe diameter should be Ø9.52/Ø15.88 mm (Liquid/Gas).

When connecting AUXK036GLEH, AUXK045GLEH, and AUXK054GLEH to an outdoor unit other than the outdoor unit of the J-IVL Series, the gas pipe diameter should be Ø19.05 mm.

*: AUXN009/012/014GLAH can be connected to J-IVS / J-IV Series only.

Optional parts

Human Sensor Kit: UTY-SHZXC	Fresh air intake kit: UTZ-VXRA	Cassette Grille: UTG-UKYC-W, UTG-UKYA-B	WLAN adapter: UTY-TFSXZ1
Wide Panel: UTG-AKXA-W	Air Outlet Shutter Plate: UTR-YDZK	External power supply unit: UTZ-GXXA	Silver Ion Filter: UTD-HFRA
Panel Spacer: UTG-BKXA-W	Insulation kit for high humidity: UTZ-KXRRA	IR Receiver Unit: UTY-LBHXD	

Dimensions

(Unit: mm)

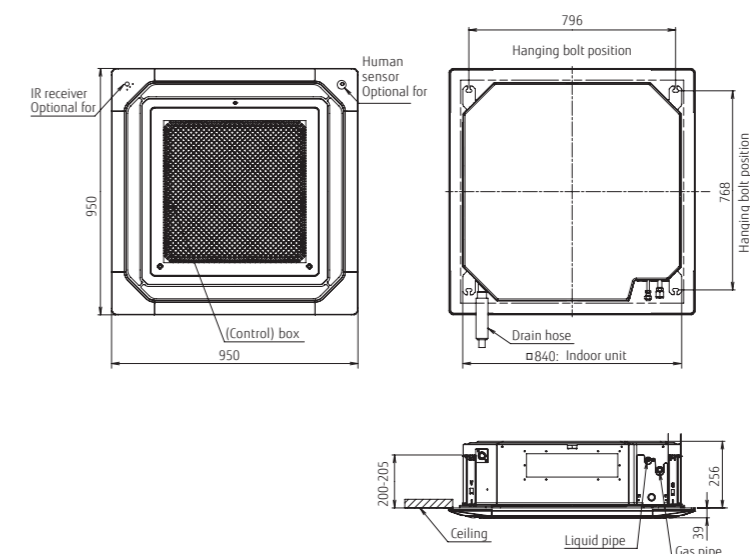

Cassette Slim type

4-way Flow



High-efficiency turbo fan with 3-dimensional blade

The 3-dimensional blade increases the amount of air that passes through the heat exchanger and improves the efficiency of airflow distribution.

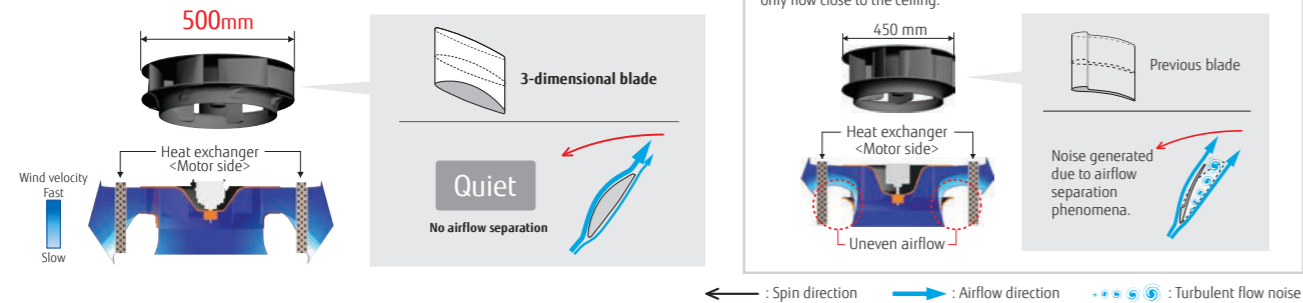

Improvement of airflow distribution

The louver distributes air evenly when it leaves the space between the chassis and the ceiling to enable the airflow to be distributed farther and more widely.

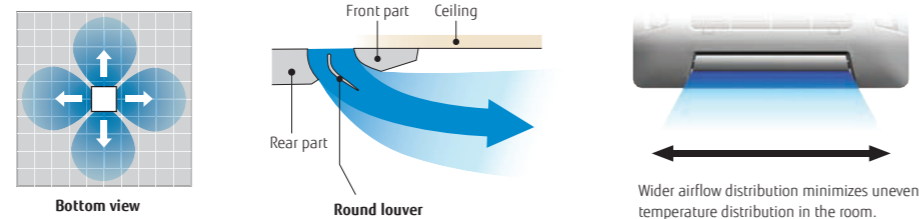

The hanger position can be adjusted after installation

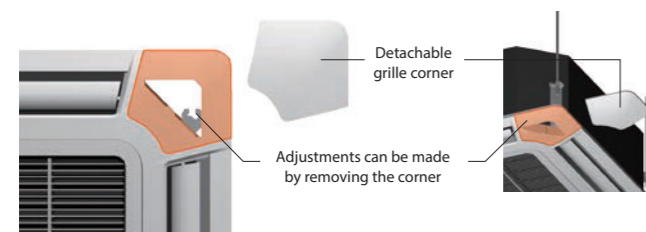

High ceiling mode

The cassette can be installed up to a height of 3.5 m.

Model code	Maximum height from floor to ceiling (m)	
	Standard mode	High ceiling mode
18	3.0	3.5
24	3.0	3.5

Model: AUXD18GALH/AUXD24GALH



Specifications

Model name		AUXD18GALH		AUXD24GALH	
Power source		Single phase, ~230 V, 50 Hz			
Capacity	Cooling	5.6		7.1	
	Heating	6.3		8.0	
Input power		39		46	
Airflow rate	High	1,150 (319)		1,280 (356)	
	Med	940 (261)		1,040 (289)	
	Low	870 (242)		870 (242)	
Sound pressure level	High	36		38	
	Med	30		33	
	Low	29		29	
Net Dimensions (H × W × D)		mm 246 × 840 × 840		246 × 840 × 840	
Weight		kg (lbs) 22 (49)		22 (49)	
Connection pipe diameter	Liquid (Flare)	9.52		9.52	
	Gas (Flare)	15.88		15.88	
Drain Hose Diameter (I.D./O.D.)		25/32			
Cassette Grille	Model name	UTG-UGYA-W			
	Net Dimensions (H × W × D)	mm 50 × 950 × 950			
Weight		kg (lbs) 5.5 (12)			

Note: Specifications are subject to the following conditions:
 Cooling: Indoor temperature of 27°CDB/19°CWB, and outdoor temperature of 35°CDB/24°CWB.
 Heating: Indoor temperature of 20°CDB/15°CWB, and outdoor temperature of 7°CDB/6°CWB.
 Pipe length: 7.5 m; Height difference between outdoor unit and indoor unit: 0 m. Voltage: 230 [V].

Optional parts

- IR receiver unit: UTY-LRHYB1
- Air outlet shutter plate: UTR-YDZC
- Panel spacer: UTG-BGYA-W
- Insulation kit for high humidity: UTZ-KXGB
- Wide panel: UTG-AGYA-W
- Fresh air intake kit: UTZ-VXGA
- Cassette Grille: UTG-UGYA-W
- WLAN adapter: UTY-TFSXZ1
- Silver Ion Filter: UTD-HFRA

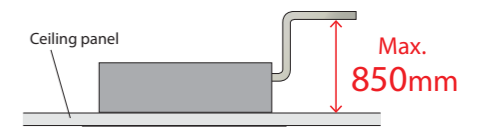

Dimensions

(Unit: mm)

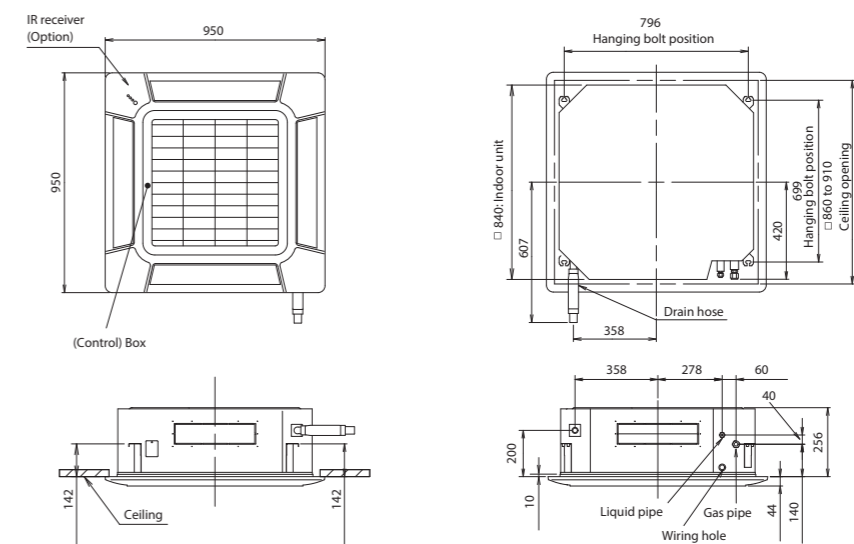

Cassette Large type

Circular Flow



Unique Circular Flow design

This Cassette type air conditioner is equipped with a high performance DC fan motor, a turbo fan, and a louver to propel powerful airflows in all directions.

- Ø7 mm high-density heat exchanger
- New DC fan motor
- High-efficiency turbo fan
- Seamless airflow louver

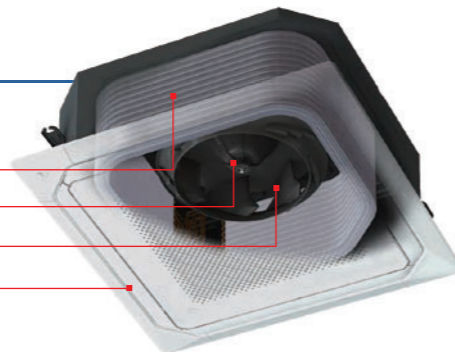

Uniform temperature air conditioning

Achieve a comfortable air conditioning spread to every corner of the room by circular flow and wide vertical airflow.

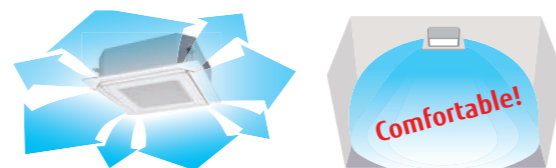

Individual louver control

Each louver can be set individually by the Touch panel wired remote controller so the user can enjoy the comfort of different directional airflows according to the room layout.

* UTY-RNRYZ5 Wired remote controller with touch panel and UTY-DCGYZ2 Central remote controller only



Comfortable air conditioning by preventing direct blowing of cold air and by providing swinging air flow simultaneously.

Provides efficient air conditioning based on the room layout

The human sensor contributes to further energy savings.

Energy saving operation starts automatically by detecting the motion of a person. Two modes of save operation mode and stop mode can be selected.

* UTY-RNRYZ5 Wired remote controller with touch panel and UTY-DCGYZ2 Central remote controller only



Human sensor (Optional)

- 2 modes are available to choose from:
- Auto economy mode** The air conditioner switches to operate on reduced power when it detects that the room is unoccupied.
 - Auto-off mode** The air conditioner stops operating when it detects that the room is unoccupied.

Model: AUXK018GLEH/AUXK024GLEH/AUXK030GLEH
AUXK034GLEH/AUXK036GLEH/AUXK045GLEH
AUXK054GLEH



Specifications

Model name	AUXK018GLEH	AUXK024GLEH	AUXK030GLEH	AUXK034GLEH	AUXK036GLEH	AUXK045GLEH	AUXK054GLEH
Power source	Single phase, ~230 V, 50 Hz						
Capacity	Cooling	5.6	7.1	9.0	10.0	11.2	14.0
	Heating	6.3	8.0	10.0	11.2	12.5	16.0
Input power	W	40	40	47	47	61	89
Airflow rate	High	1,420	1,420	1,440	1,440	1,620	1,820
	Med-High	1,360	1,360	1,400	1,400	1,500	1,590
	Med	1,300	1,300	1,340	1,340	1,400	1,500
	Med-Low	1,270	1,270	1,300	1,300	1,340	1,400
	Low	1,200	1,200	1,280	1,280	1,280	1,300
Sound pressure level	Quiet	1,150	1,150	1,150	1,150	1,150	1,150
	High	38	38	39	39	41	44
	Med-High	37	37	38	38	40	42
	Med	36	36	37	37	38	40
	Med-Low	35	35	36	36	37	38
Dimensions (H × W × D)	mm	288 × 840 × 840					
	kg (lbs)	26.5 (58)	26.5 (58)	29.5 (65)	29.5 (65)	29.5 (65)	29.5 (65)
Connection pipe diameter	Liquid (Flare)	6.35	9.52	9.52	9.52	9.52	9.52
	Gas (Flare)	12.70	15.88	15.88	15.88	15.88	15.88
Drain Hose Diameter (I.D./O.D.)	25/32						
Cassette Grille	Model name	UTG-UKYC-W/UTG-UKYA-B					
	Dimensions (H × W × D)	53 × 950 × 950					
Weight	kg (lbs)	6.0 (13)					

Note: Specifications are subject to the following conditions:
Cooling: Indoor temperature of 27°CDB/19°CWB, and outdoor temperature of 35°CDB/24°CWB.
Heating: Indoor temperature of 20°CDB/15°CWB, and outdoor temperature of 7°CDB/6°CWB.
Pipe length: 7.5 m; Height difference between outdoor unit and indoor unit: 0 m. Voltage: 230 [V].
When AUX*018GLEH is connected to an outdoor unit other than one of the J-IVL Series, the pipe diameter should be Ø9.52/Ø15.88 mm (Liquid/Gas).
When connecting AUXK036GLEH, AUXK045GLEH, and AUXK054GLEH to an outdoor unit other than the outdoor unit of the J-IVL Series, the gas pipe diameter should be Ø19.05 mm.

Optional parts

Human Sensor Kit: UTY-SHZXC	Fresh air intake kit: UTZ-VXRA	Cassette Grille: UTG-UKYC-W, UTG-UKYA-B	WLAN adapter: UTY-TFSXZ1
Wide Panel: UTG-AKXA-W	Air Outlet Shutter Plate: UTR-YDZK	External power supply unit: UTZ-GXXA	Silver Ion Filter: UTD-HFRA
Panel Spacer: UTG-BKXA-W	Insulation kit for high humidity: UTZ-KXRA	IR Receiver Unit: UTY-LBHXD	

Dimensions

(Unit: mm)

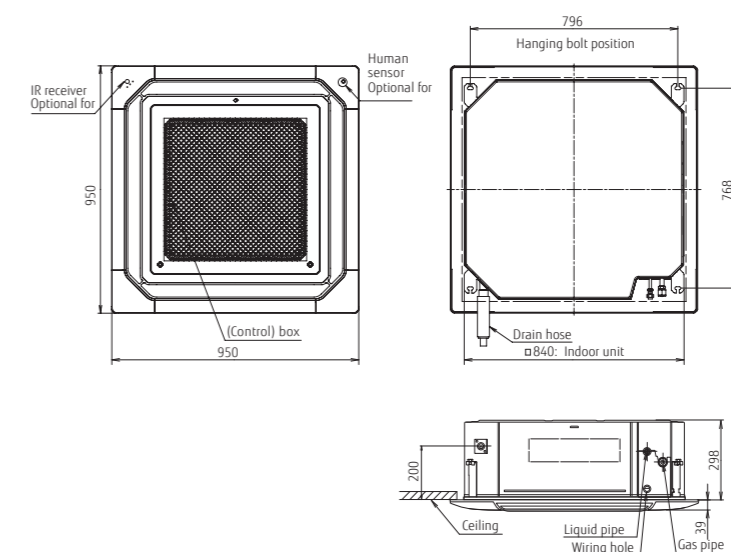

Cassette Large type

4-way Flow



High-efficiency turbo fan with 3-dimensional blade

The 3-dimensional blade increases the amount of air that passes through the heat exchanger and improves the efficiency of airflow distribution.

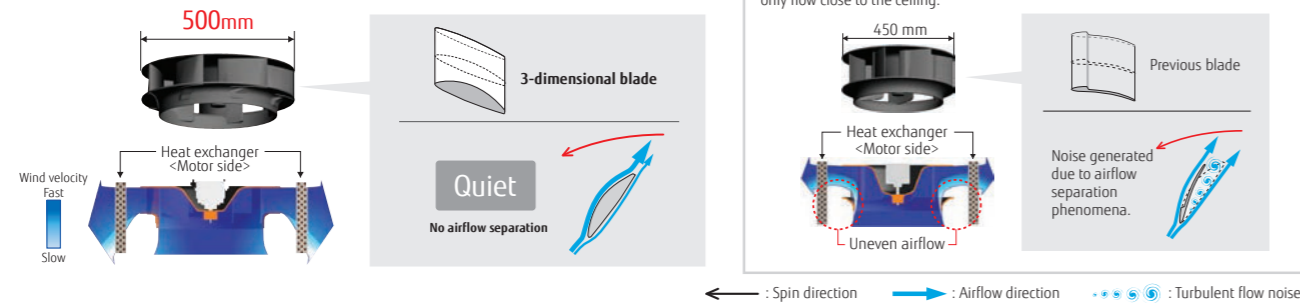

Improvement of airflow distribution

The louver distributes air evenly when it leaves the space between the chassis and the ceiling to enable the airflow to be distributed farther and more widely.

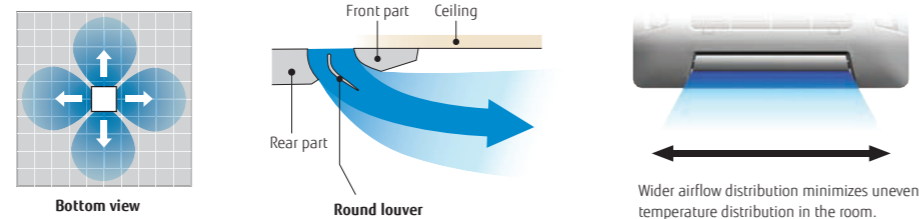

The hanger position can be adjusted after installation

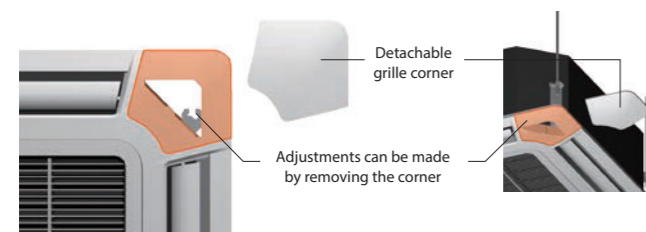

High ceiling mode

The cassette can be installed up to a height of 4.2 m (36/45/54).

Model code	Maximum height from floor to ceiling (m)	
	Standard mode	High ceiling mode
18	3.2	3.5
24	3.2	3.5
30	3.2	3.6
34	3.2	3.6
36	3.2	4.2
45	3.2	4.2
54	3.2	4.2

Model: AUXA18GALH/AUXA24GALH/AUXA30GALH
 AUXA34GALH/AUXA36GALH/AUXA45GALH
 AUXA54GALH



Specifications

Model name	AUXA18GALH*	AUXA24GALH*	AUXA30GALH	AUXA34GALH	AUXA36GALH	AUXA45GALH	AUXA54GALH
Power source	Single phase, ~230 V, 50 Hz						
Capacity	Cooling	5.6	7.1	9.0	10.0	11.2	14.0
	Heating	6.3	8.0	10.0	11.2	12.5	16.0
Input power	W	51	51	59	77	80	119
Airflow rate	High	1,420 (394)	1,420 (394)	1,600 (444)	1,750 (486)	1,800 (500)	1,900 (528)
	Med	1,230 (342)	1,230 (342)	1,300 (361)	1,300 (361)	1,300 (361)	1,370 (381)
	Low	1,100/1,000*(306/278)	1,100/1,000*(306/278)	1,100 (306)	1,100 (306)	1,100 (306)	1,100 (306)
Sound pressure level	High	40	40	40	43	44	47
	Med	36	36	38	38	38	39
	Low	33/31*1	33/31*1	33/31*1	33/31*1	33/31*1	33/31*1
Net Dimensions (H × W × D)	mm	288 × 840 × 840	288 × 840 × 840	288 × 840 × 840	288 × 840 × 840	288 × 840 × 840	288 × 840 × 840
Weight	kg (lbs)	27 (60)	27 (60)	27 (60)	27 (60)	27 (60)	27 (60)
Connection pipe diameter	Liquid (Flare)	9.52	9.52	9.52	9.52	9.52	9.52
	Gas (Flare)	15.88	15.88	15.88	19.05	19.05	19.05
Drain Hose Diameter (I.D./O.D.)		25/32					
Cassette Grille	Model name	UTG-UGYA-W					
	Net Dimensions (H × W × D)	50 × 950 × 950					
Weight	kg (lbs)	5.5 (12)					

Note: Specifications are subject to the following conditions:
 Cooling: Indoor temperature of 27°CDB/19°CWB, and outdoor temperature of 35°CDB/24°CWB.
 Heating: Indoor temperature of 20°CDB/(15°CWB), and outdoor temperature of 7°CDB/6°CWB.
 Pipe length: 7.5 m; Height difference between outdoor unit and indoor unit: 0 m. Voltage: 230 [V].
 *1: This value is under cooling operation.
 *: AUXA18/24GALH can be connected to VR-IV/V-III Series only.

Optional parts

- IR receiver unit: UTY-LRHYB1
- Air outlet shutter plate: UTR-YDZC
- Panel spacer: UTG-BGYA-W
- Insulation kit for high humidity: UTG-KXGA
- Wide panel: UTG-AGYA-W
- Fresh air intake kit: UTZ-VXGA
- WLAN adapter: UTY-TFSXZ1
- Cassette Grille: UTG-UGYA-W
- Silver Ion Filter: UTD-HFRA

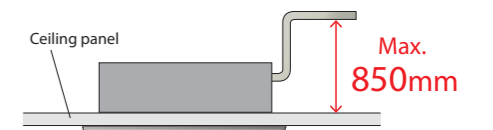

Dimensions

(Unit: mm)

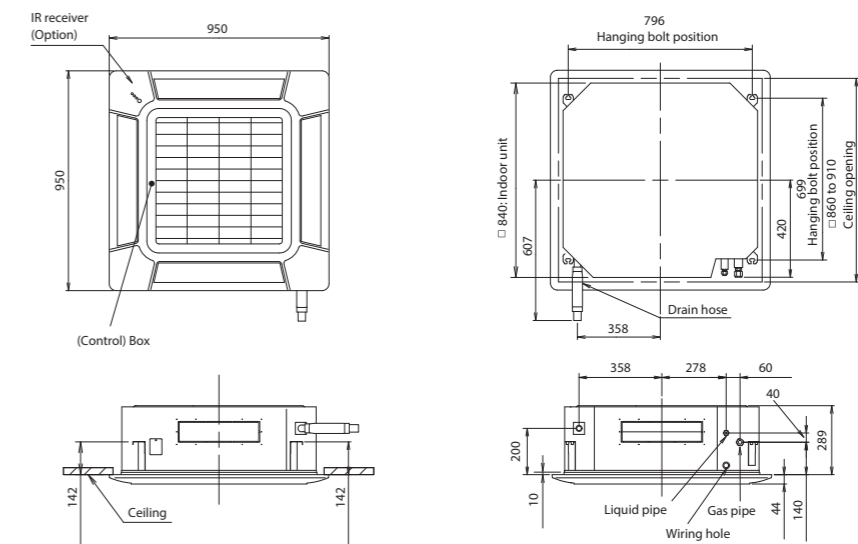

Low Static Pressure Duct Mini Duct (With drain pump)



Space saving design

- Fits into a space 198 mm high and 450 mm deep
- 30% smaller than previous-generation models
- Weighs 16 kg, 10% lighter

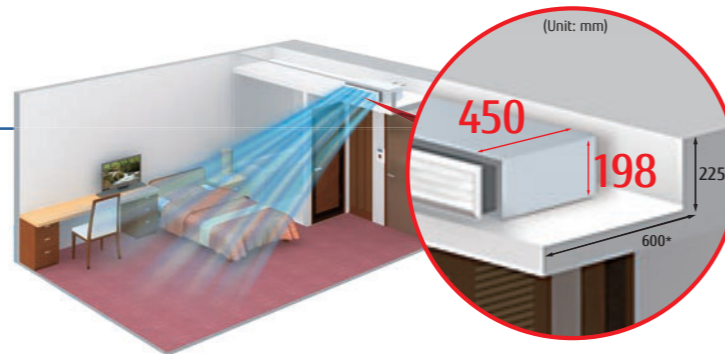

*: Minimum clearance requirement

Optimum airflow path and low noise operation

The stabilized airflow reduces the noise level significantly.

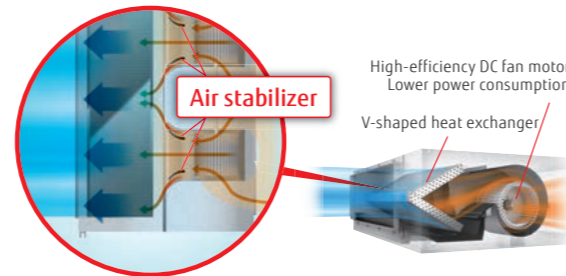

6-speed control*

Multistep airflow adjustment allows installation in a quiet location.

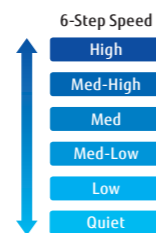
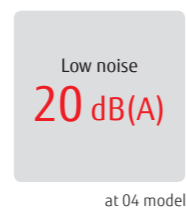

* Remote controller is compatible with the following:
UTY-RNRY25/UTY-RLRV/UTY-RSRV/UTY-RHRV/UTY-DCGY22/UTY-ALGX21/UTY-APGX21

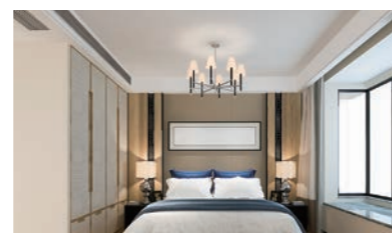

Easy to design and maintain for drain

Indoor unit design for easy maintenance. Parts can be replaced from the side of the unit where maintenance is easier.

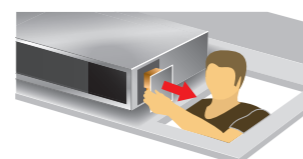

A drain pump is built into the unit as standard. Parts can be accessed and replaced through the side of the unit for easy maintenance.

Model: ARXK004GLGH/ARXK007GLGH/ARXK009GLGH
ARXK012GLGH/ARXK014GLGH/ARXK018GLGH
ARXK024GLGH



Specifications

Model name	ARXK004GLGH	ARXK007GLGH	ARXK009GLGH	ARXK012GLGH	ARXK014GLGH	ARXK018GLGH	ARXK024GLGH
Power source	Single phase, ~230 V, 50 Hz						
Capacity	Cooling	1.1	2.2	2.8	3.6	4.5	7.1
	Heating	1.3	2.8	3.2	4.0	5.0	8.0
Input power	W	26	28	28	35	66	80
Airflow rate	High	460	460	460	550	760	1,160
	Med-High	440	440	440	520	660	1,060
	Med	420	420	420	480	560	960
	Med-Low	400	400	400	450	490	860
	Low	370	370	370	410	410	750
Quiet	340	340	340	340	340	470	610
Static pressure range	Pa	0 to 30	0 to 30	0 to 30	0 to 30	0 to 50	0 to 50
Standard static pressure		10	10	10	10	15	15
Sound pressure level	High	25	26	26	29	34	32
	Med-High	24	25	25	27	31	30
	Med	23	24	24	26	28	28
	Med-Low	22	23	23	25	26	27
	Low	21	22	22	24	24	25
Quiet	20	21	21	22	22	22	
Net Dimensions (H × W × D)	mm	198 × 700 × 450	198 × 700 × 450	198 × 700 × 450	198 × 700 × 450	198 × 900 × 450	198 × 1,100 × 450
Weight	kg (lbs)	14.5 (32)	15.5 (34)	15.5 (34)	16 (35)	16 (35)	22.5 (50)
Connection pipe diameter	Liquid (Flare)	6.35	6.35	6.35	6.35	6.35	9.52
	Gas (Flare)	9.52	9.52	9.52	12.70	12.70	15.88
Drain Hose Diameter (I.D./O.D.)		25/32					

Note: Specifications are subject to the following conditions:
Cooling: Indoor temperature of 27°CDB/19°CWB, and outdoor temperature of 35°CDB/24°CWB.
Heating: Indoor temperature of 20°CDB/15°CWB, and outdoor temperature of 7°CDB/6°CWB.
Pipe length: 7.5 m; Height difference between outdoor unit and indoor unit: 0 m. Voltage: 230 [V].

Optional parts

Remote sensor unit:	UTY-XSZX	External power supply unit:	UTZ-GXXA
IR receiver unit:	UTB-YWC	Auto Louver Grille Kit:	UTD-GXTA-W (004-014)
Silver Ion Filter:	UTD-HFTA (004-014)		UTD-GXTB-W (018)
	UTD-HFTB (018)		UTD-GXTC-W (024)
	UTD-HFTC (024)		

Auto Louver Grille Kit (Optional)

The slim design of the unit provides comfortable cooling and heating air conditioning over a wide area. The optional automatic louver grille, which fits nicely into any interior decor, provides comfortable air conditioning (Optional)

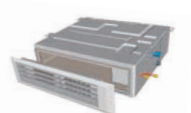

Dimensions

(Unit: mm)

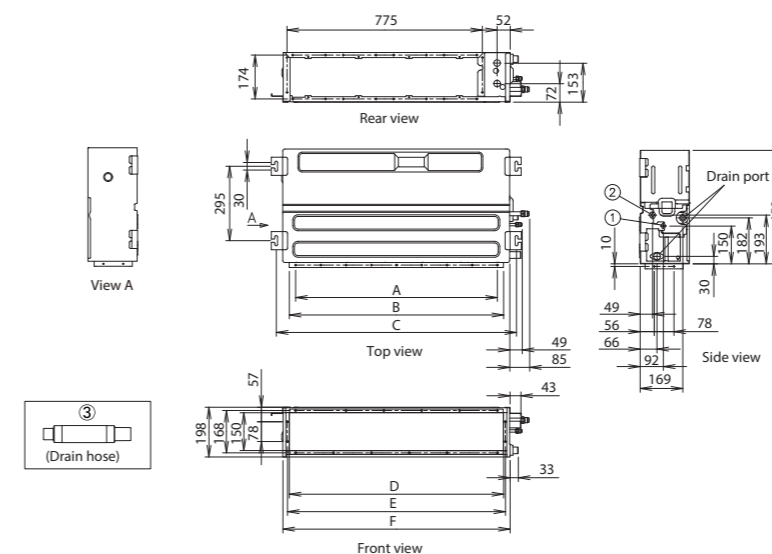

- ① Refrigerant pipe flare connection (Liquid)
- ② Refrigerant pipe flare connection (Gas)
- ③ Drain hose connection

	ARXK004-014	ARXK018	ARXK024
A	P100×6=600	P100×8=800	P100×10=1000
B	650	850	1050
C	752	952	1152
D	650	850	1050
E	665	864	1064
F	700	900	1100

Low Static Pressure Duct Slim Duct/Slim Concealed Floor



Slim design

Slim design allows for installation in a tight ceiling space.

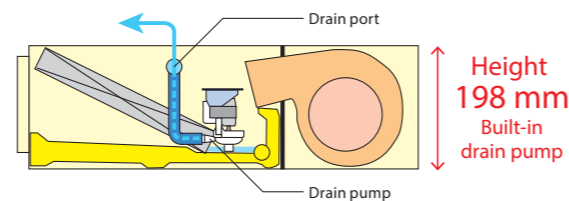

Air intake

Air intake direction can be selected to match the installation site.

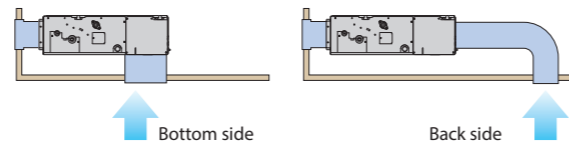

Flexible installation

Ceiling concealed

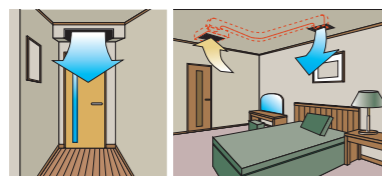

Floor concealed

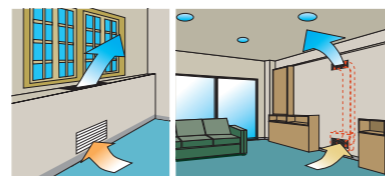

Wide range of static pressures

The use of a DC fan motor makes it possible to adjust the static pressure between 0 and 90 Pa. The static pressure range can be changed by a remote controller.



Static pressure range
0 to 90 Pa

*024 model static pressure range is 0 to 50 Pa.

Filter (Accessory)

ARXD04/007/009/012/014/018 ARXD024

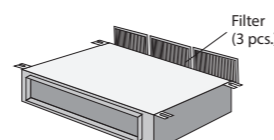
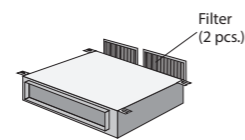

Model: ARXD04GALH/ARXD007GLEH/ARXD009GLEH
ARXD012GLEH/ARXD014GLEH/ARXD018GLEH
ARXD024GLEH



ARXD04GALH
ARXD007/009/012/014GLEH



ARXD018GLEH



ARXD024GLEH

Slim Concealed Floor



Specifications

Model name	ARXD04GALH*	ARXD007GLEH	ARXD009GLEH	ARXD012GLEH	ARXD014GLEH	ARXD018GLEH	ARXD024GLEH
Power source	Single phase, ~230 V, 50 Hz						
Capacity	Cooling	1.1	2.2	2.8	3.6	4.5	7.1
	Heating	1.3	2.8	3.2	4.0	5.0	8.0
Input power	W	40	44	50	54	92	122
Airflow rate	High	510	550	600	600	800	1,330
	Med-High	-	480	510	530	680	1,140
	Med	400/470*1	440	460	490	600	1,020
	Med-Low	-	410	420	450	520	900
	Low	320/440*1	370	370	410	440	780
Quiet	-	320	320	340	340	470	610
Static pressure range	Pa	0 to 90	0 to 90	0 to 90	0 to 90	0 to 90	0 to 50
Standard static pressure	Pa	25	25	25	25	25	25
Sound pressure level	High	26	28	29	30	34	35
	Med-High	-	26	27	28	32	31
	Med	21/25*1	25	25	27	30	29
	Med-Low	-	24	24	26	28	27
	Low	20/22*1	22	22	24	25	24
Quiet	-	21	21	22	22	23	21
Net Dimensions (H × W × D)	mm	198 × 700 × 620	198 × 700 × 620	198 × 700 × 620	198 × 700 × 620	198 × 700 × 620	198 × 900 × 620
Weight	kg (lbs)	17 (37)	17 (37)	17 (37)	18 (40)	18 (40)	26 (57)
Connection pipe diameter	Liquid (Flare)	6.35	6.35	6.35	6.35	6.35	9.52
	Gas (Flare)	12.70	9.52	9.52	12.70	12.70	15.88
Drain Hose Diameter (I.D./O.D.)				25/32			

Note: Specifications are subject to the following conditions:
Cooling: Indoor temperature of 27°CDB/19°CWB, and outdoor temperature of 35°CDB/24°CWB.
Heating: Indoor temperature of 20°CDB/15°CWB, and outdoor temperature of 7°CDB/6°CWB.
Pipe length: 7.5 m; Height difference between outdoor unit and indoor unit: 0 m. Voltage: 230 [V].
*1: This value is under cooling operation.
*: ARXD04GALH cannot be connected to J-IVS/J-IVJ-IVL/VR-IV Series.

Optional parts

Remote sensor unit: UTY-XSZX
IR receiver unit: UTB-YWC (04)
Silver Ion Filter: UTD-HFTA (04, 007-014)
UTD-HFTB (018)
UTD-HFTC (024)

External power supply unit: UTZ-GXXA
Auto Louver Grille Kit: UTD-GXTA-W (04, 007-014)
UTD-GXTB-W (018)
UTD-GXTC-W (024)

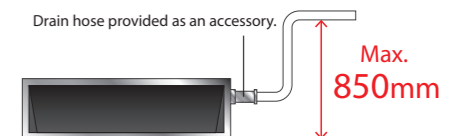

Dimensions

(Unit: mm)

*Maintenance accessibility should be considered when installing the product. Refer to the installation manual for the required maintenance access size.

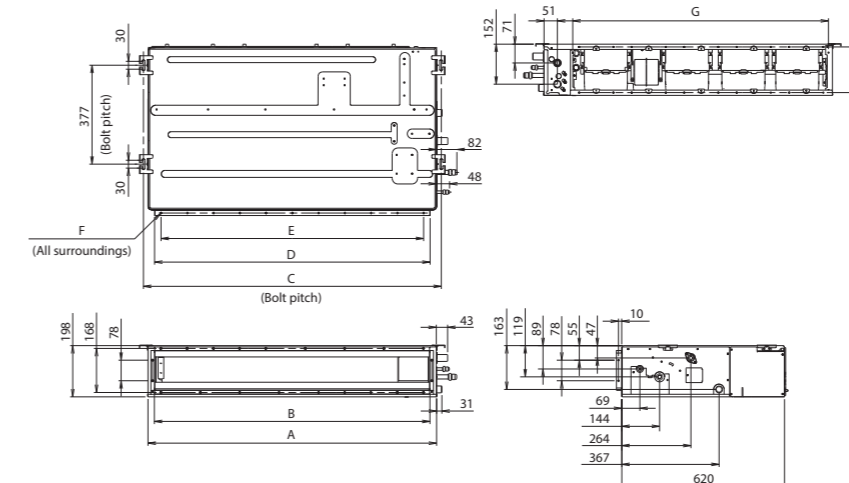

	ARXD04-014	ARXD018	ARXD024
A	700	900	1100
B	650	850	1050
C	734	934	1134
D	650	850	1050
E	P100 × 6 = 600	P100 × 8 = 800	P100 × 10 = 1000
F	18 × Ø5	22 × Ø5	26 × Ø5
G	574	774	974

Low Static Pressure Duct
Slim Duct
High-efficiency



High-volume airflow

High-volume airflow enables installation in places where an early exchange of air is required.



Slim & Compact Design

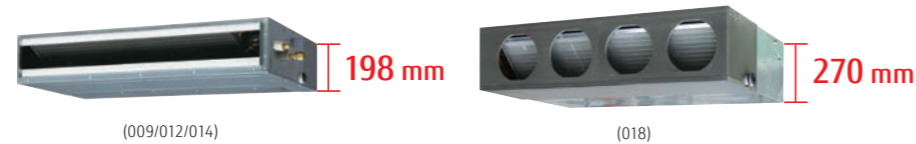

Flexible installation

Ceiling concealed

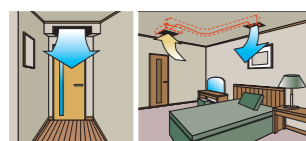

Floor concealed

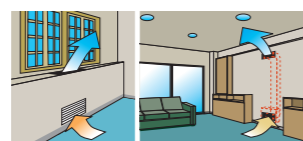

Installation styles

Embedded in Ceiling

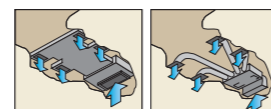

Hanging from the ceiling

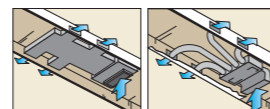

Model: ARXP009GLAH/ARXP012GLAH/ARXP014GLAH/ARXP018GLAH * Production by order

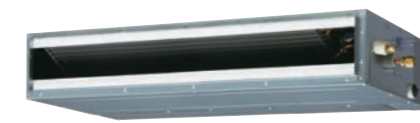

ARXP009/012/014GLAH



ARXP018GLAH

Specifications

Model name		ARXP009GLAH	ARXP012GLAH	ARXP014GLAH	ARXP018GLAH
Power source		Single phase, ~230 V, 50 Hz			
Capacity	Cooling	2.8	3.6	4.5	5.6
	Heating	3.2	4.0	5.0	6.3
Input power		88	122	122	173
Airflow rate	High	1,100	1,330	1,330	1,720
	Med-High	-	-	-	-
	Med	1,010	1,240	1,240	1,470
	Med-Low	-	-	-	-
	Low	880	1,100	1,100	1,360
	Quiet	-	-	-	-
Static pressure range		0 to 50	0 to 50	0 to 50	0 to 80
Standard static pressure		25	25	25	50
Sound pressure level	High	32	35	35	36
	Med-High	-	-	-	-
	Med	30	32	32	33
	Med-Low	-	-	-	-
	Low	28	29	29	30
	Quiet	-	-	-	-
Net Dimensions (H × W × D)		mm 198 × 1,100 × 620	198 × 1,100 × 620	198 × 1,100 × 620	270 × 1,135 × 700
Weight		kg (lbs) 26 (57)	26 (57)	26 (57)	40 (88)
Connection pipe diameter	Liquid (Flare)	6.35	6.35	6.35	6.35
	Gas (Flare)	12.70	12.70	12.70	12.70
Drain Hose Diameter (I.D./O.D.)		25/32			

Note: Specifications are subject to the following conditions:

Cooling: Indoor temperature of 27°CDB/19°CWB, and outdoor temperature of 35°CDB/24°CWB.

Heating: Indoor temperature of 20°CDB/(15°CWB), and outdoor temperature of 7°CDB/6°CWB.

Pipe length: 7.5 m; Height difference between outdoor unit and indoor unit: 0 m. Voltage: 230 [V].

Low-Static Pressure Duct Slim Duct High-Efficiency can be connected to the J-IVS/J-IVJ-IVL Series only.

Optional parts

- IR receiver unit: UTB-YWC
- Long-life filter: UTD-LF25NA (018)
- Flange: UTD-RF204 (018)
- Drain pump unit: UTZ-PX1NBA (018)
- Remote sensor unit: UTY-XSZX
- Auto Louver Grille Kit: UTD-GXTC-W (009-014)
- Silver Ion Filter: UTD-HFTC (009-014)

Dimensions

(Unit: mm)

Models: ARXP009/ARXP012/ARXP014

Models: ARXP018

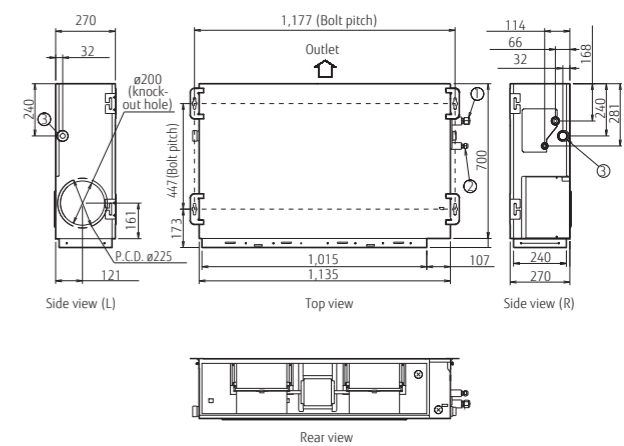
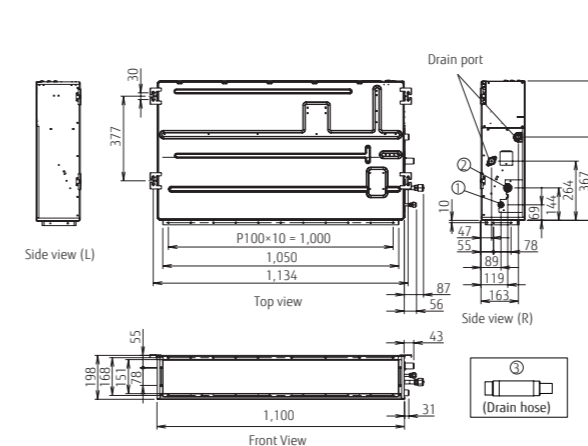

- ① Refrigerant pipe flare connection (Liquid)
- ② Refrigerant pipe flare connection (Gas)
- ③ Drain pipe connection

- ① Refrigerant pipe flare connection (Liquid)
- ② Refrigerant pipe flare connection (Gas)
- ③ Drain pipe connection

Medium static pressure duct Normal



Slim & Compact Design

The slim and compact design of the indoor unit, with the control box mounted on the side, allows installation in narrow spaces.

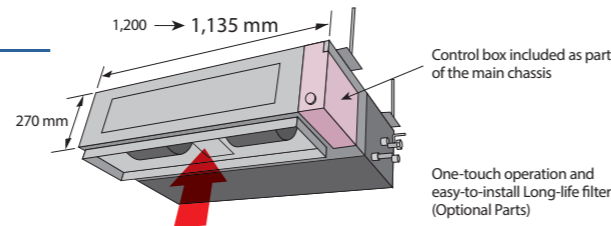

Easy maintenance

Structural improvement has been developed by making the bottom panel in two pieces, front and rear. The internal fan casing is also manufactured in two pieces—upper and lower. The motor and fan can be easily accessed and maintained by removing the rear panel and the lower casing with the main chassis remaining in place.

See below for rear-suction type

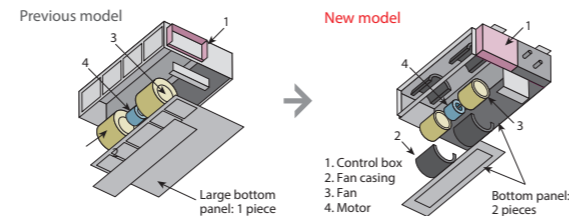

Installation styles

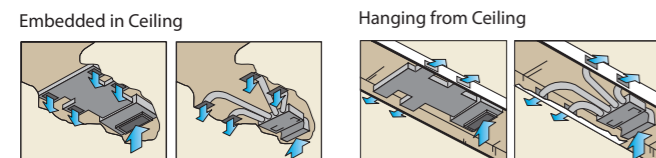

A drain pipe can be installed on either the left or right side of the unit

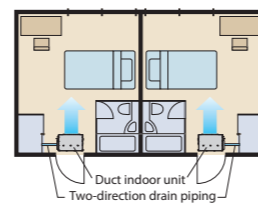

High-efficiency DC fan motor achieves low-energy consumption.

Improved motor efficiency from previous model.

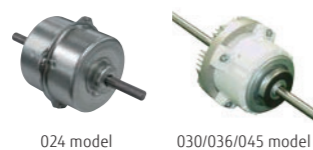

Wide range of static pressures

Static pressures can be changed in the range of 0 to 150 Pa.

Static pressure range
0 to 150 Pa

Model: ARXA024GLEH/ARXA030GLEH/ARXA036GLEH/ARXA045GLEH



Specifications

Model name			ARXA024GLEH	ARXA030GLEH	ARXA036GLEH	ARXA045GLEH
Power source			Single phase, ~230 V, 50 Hz			
Capacity	Cooling	kW	7.1	9.0	11.2	12.5
	Heating	kW	8.0	10.0	12.5	14.0
Input power	W		94	108	194	240
Airflow rate	High	m ³ /h	1,280	1,410	1,840	1,970
	Med-High		1,180	1,350	1,750	1,910
	Med		1,090	1,280	1,660	1,860
	Med-Low		1,000	1,240	1,600	1,780
	Low		920	1,190	1,530	1,710
Quiet	840	1,150	1,470	1,640		
Static pressure range	Pa		0 to 150	0 to 150	0 to 150	0 to 150
Standard static pressure			40	50	50	60
Sound pressure level	High	dB(A)	31	34	37	41
	Med-High		29	33	36	40
	Med		27	32	35	38
	Med-Low		26	31	35	38
	Low		24	30	34	37
Quiet	23	29	33	36		
Net Dimensions (H × W × D)	mm		270 × 1,135 × 700	270 × 1,135 × 700	270 × 1,135 × 700	270 × 1,135 × 700
Weight	kg (lbs)		36 (79)	40 (88)	40 (88)	40 (88)
Connection pipe diameter	Liquid (Flare)	mm	9.52	9.52	9.52	9.52
	Gas (Flare)		15.88	15.88	15.88	15.88
Drain Hose Diameter (I.D./O.D.)			25/32			

Note: Specifications are subject to the following conditions:
Cooling: Indoor temperature of 27°CDB/19°CWB, and outdoor temperature of 35°CDB/24°CWB.
Heating: Indoor temperature of 20°CDB/15°CWB, and outdoor temperature of 7°CDB/6°CWB.
Pipe length: 7.5 m; Height difference between outdoor unit and indoor unit: 0 m. Voltage: 230 [V].

Optional parts

Long-life filter:	UTD-LF25NA	IR receiver unit:	UTY-TRHX
Flange (square):	UTD-SF045T	Drain pump unit:	UTZ-PX1NBA
Flange (round):	UTD-RF204	WLAN adapter:	UTY-TFSXZ1
External power supply unit:	UTZ-GXXA	Silver Ion Filter:	UTD-HFND

Dimensions

(Unit: mm)

*Maintenance accessibility should be considered when installing the product. Refer to the installation manual for the required maintenance access size.

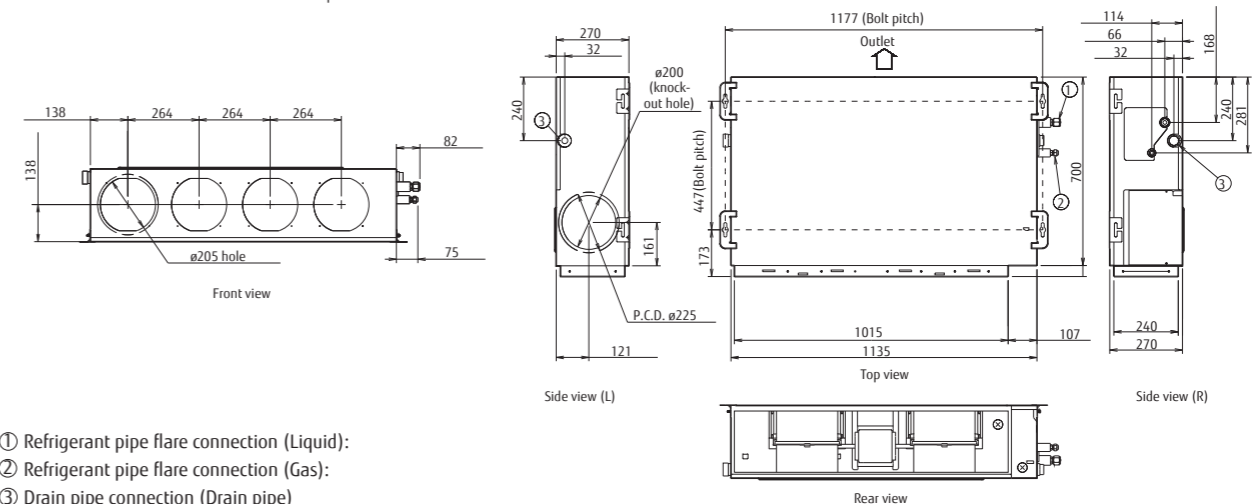

- ① Refrigerant pipe flare connection (Liquid):
- ② Refrigerant pipe flare connection (Gas):
- ③ Drain pipe connection (Drain pipe)

Medium static pressure duct High-efficiency



High-volume airflow

High-volume airflow enables installation in places where an early exchange of air is required.

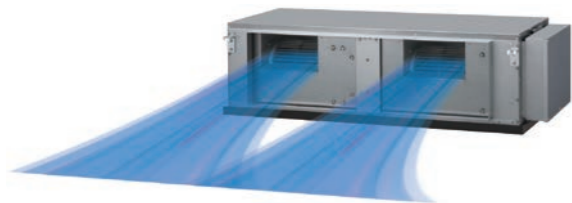

Wide range of static pressures

Static pressure range
50 to 150 Pa

(ARXN024)



Installation styles

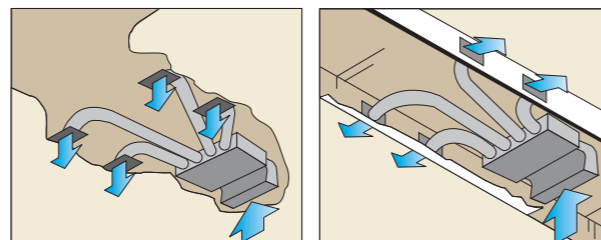

Model: ARXQ018GTAH/ARXQ024GTAH * Production by order



Specifications

Model name		ARXQ018GTAH	ARXQ024GTAH
Power source		Single phase, ~230 V, 50 Hz	
Capacity	Cooling	5.6	7.1
	Heating	6.3	8.0
Input power		154	205
Airflow rate	High	2,280	2,640
	Med	-	-
	Low	-	-
Static pressure range		50 to 100	50 to 150
Standard static pressure		50	50
Sound pressure level	High	35	37
	Med	-	-
	Low	-	-
Net Dimensions (H x W x D)		450 x 1,587 x 700	450 x 1,587 x 700
Weight		84 (185)	84 (185)
Connection pipe diameter	Liquid	9.52 (Flare)	9.52 (Flare)
	Gas	15.88 (Flare)	15.88 (Flare)
Drain Hose Diameter (I.D./O.D.)		25/32	

Note: Specifications are based on the following conditions:
Cooling: Indoor temperature of 27°CDB/19°CWB, and outdoor temperature of 35°CDB/24°CWB.
Heating: Indoor temperature of 20°CDB/15°CWB, and outdoor temperature of 7°CDB/6°CWB.
Pipe length: 7.5 m; Height difference between outdoor unit and indoor unit: 0 m. Voltage: 230 [V]
*Medium Static Pressure Duct High Efficiency can be connected to the V-III Series and VR-IV Series.

Optional parts

Remote sensor unit: UTY-XSZX

Dimensions

(Unit: mm)

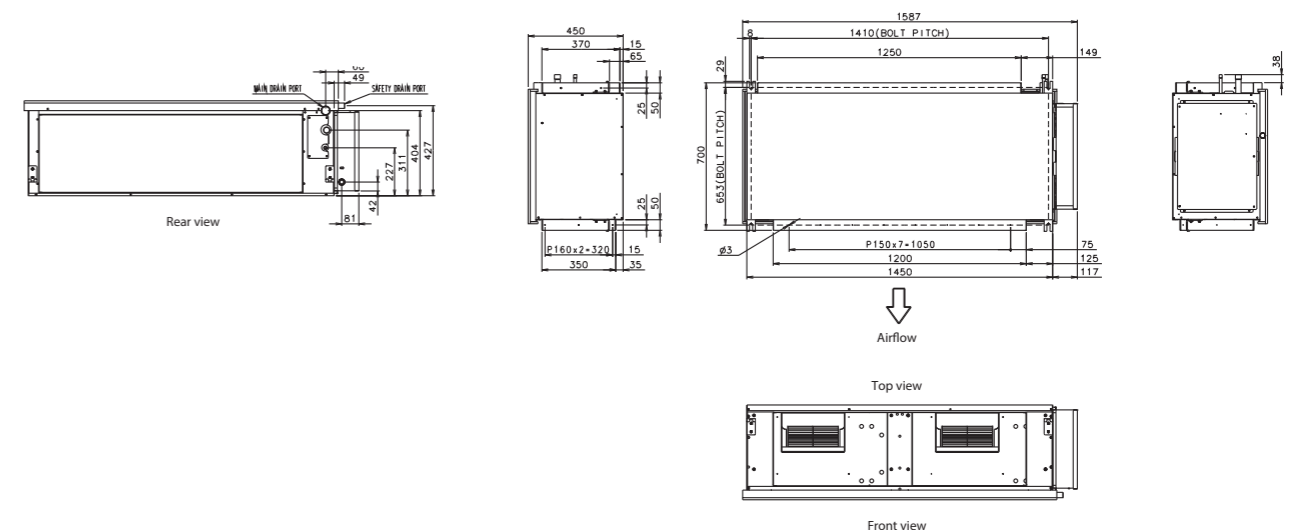

Medium static pressure duct High-efficiency



High-volume airflow

High-volume airflow enables installation in places where an early exchange of air is required.



Quiet operation

Multistep airflow adjustment allows installation in a quiet location.

Low noise
26 dB(A)
024/030 models:

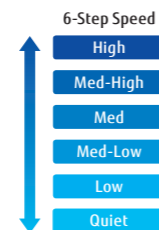

Slim & Compact Design



Model: ARXP024GTAH/ARXP030GTAH * Production by order



Specifications

Model name		ARXP024GTAH	ARXP030GTAH
Power source		Single phase, ~230 V, 50 Hz	
Capacity	Cooling	7.1	9.0
	Heating	8.0	10.0
Input power		180	273
Airflow rate	High	2,100	2,700
	Med-High	2,050	2,390
	Med	1,860	2,080
	Med-Low	1,660	1,770
	Low	1,470	1,470
	Quiet	1,260	1,260
Static pressure range		0 to 100	
Standard static pressure		50	50
Sound pressure level	High	37	41
	Med-High	35	38
	Med	33	34
	Med-Low	31	31
	Low	28	28
	Quiet	26	26
Net Dimensions (H × W × D)		300 × 1,400 × 700	
Weight		48 (106)	48 (106)
Connection pipe diameter	Liquid (Flare)	9.52	9.52
	Gas (Flare)	15.88	15.88
Drain Hose Diameter (I.D./O.D.)		25/32	

Note: Specifications are subject to the following conditions:

Cooling: Indoor temperature of 27°CDB/19°CWB, and outdoor temperature of 35°CDB/24°CWB.

Heating: Indoor temperature of 20°CDB/(15°CWB), and outdoor temperature of 7°CDB/6°CWB.

Pipe length: 7.5 m; Height difference between outdoor unit and indoor unit: 0 m. Voltage: 230 [V]

Optional parts

- IR receiver unit: UTB-YWC
- Long-life filter: UTD-LFNA
- Remote sensor unit: UTY-XSZX
- Silver Ion Filter: UTD-HFNA

Dimensions

(Unit: mm)

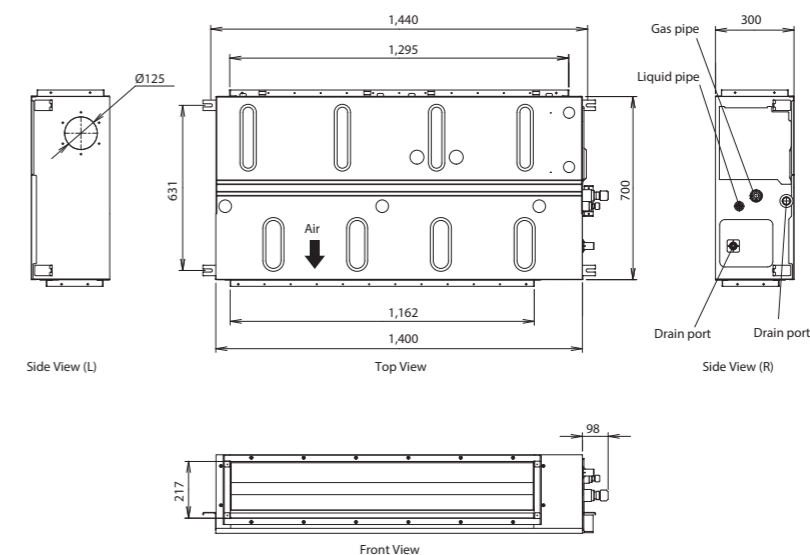

High Static Pressure Duct Normal



Model: ARXC036GTEH/ARXC45GATH/ARXC60GATH
ARXC072GTEH/ARXC090GTEH/ARXC096GTEH



ARXC036GTEH
ARXC45/60GATH



ARXC072/090GTEH



ARXC096GTEH

Static pressure mode selection

The use of a DC fan motor makes it possible to adjust the static pressure between 0 to 200 Pa (ARXC036)/300 Pa (ARXC072/090/096).

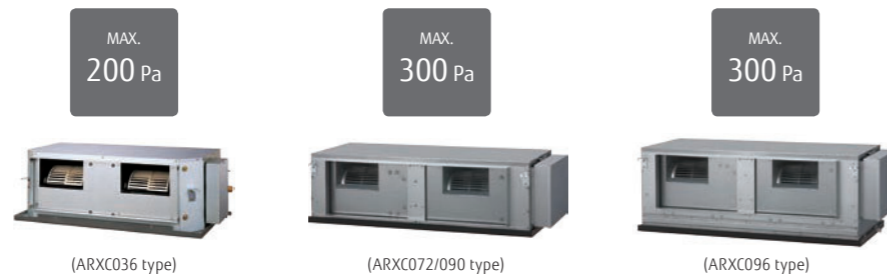

Easy installation (Compact & Lightweight)

The indoor unit is designed to be compact and light by reducing the basic chassis size and the overall material weight.



Low noise

Models: ARXC036/ARXC45/ARXC60
The corners of the front panel and fan casing of the indoor unit are shaved to reduce air turbulence. The use of a plastic case and fan reduces the noise level generated by the unit.

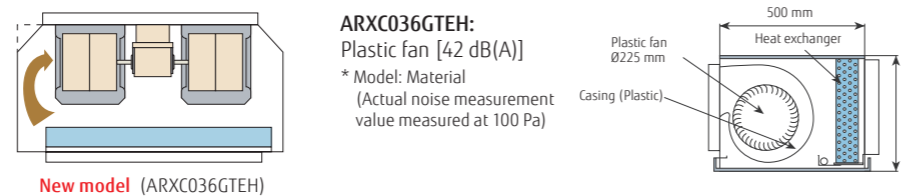

High-efficiency DC fan motor achieves low energy consumption.

Improved motor efficiency compared to the previous model



Specifications

Model name	ARXC036GTEH	ARXC45GATH	ARXC60GATH*	ARXC072GTEH*	ARXC090GTEH*	ARXC096GTEH*
Power source	Single phase, ~230 V, 50 Hz					
Capacity	Cooling	11.2	12.5	18.0	22.4	28.0
	Heating	12.5	14.0	20.0	25.0	31.5
Input power	W	207	715	730	681	838
Airflow rate	High	1,990	3,500	3,500	3,900	4,300
	Med	1,680	3,000	3,000	3,300	4,000
	Low	1,330	2,460	2,460	3,000	3,500
Static pressure range	Pa	0 to 200	100 to 250	100 to 250	0 to 300	0 to 300
Standard static pressure	Pa	100	100	100	150	150
Sound pressure level	High	42	49	49	47	48
	Med	36	45	45	43	46
	Low	32	42	42	40	44
Net Dimensions (H × W × D)	mm	400 × 1,050 × 500	400 × 1,050 × 500	400 × 1,050 × 500	450 × 1,587 × 700	450 × 1,587 × 700
Weight	kg (lbs)	40 (88)	46 (101)	46 (101)	84 (185)	84 (185)
Connection pipe diameter	Liquid	9.52 (Flare)	9.52 (Flare)	9.52 (Flare)	9.52 (Flare)	9.52 (Flare)
	Gas	15.88 (Flare)	19.05 (Flare)	19.05 (Flare)	19.05 (Flare)	19.05 (Flare)
Drain Hose Diameter (I.D./O.D.)	25/32					

Note: Specifications are based on the following conditions:
Cooling: Indoor temperature of 27°CDB/19°CWB, and outdoor temperature of 35°CDB/24°CWB.
Heating: Indoor temperature of 20°CDB/15°CWB, and outdoor temperature of 7°CDB/6°CWB.
Pipe length: 7.5 m; Height difference between outdoor unit and indoor unit: 0 m. Voltage: 230 [V]
*: ARXC60/072/090/096G cannot be connected to J-IVJ-IVS Series.

Optional parts

- Long-life filter: UTD-LF60KA (036/45/60)
- IR receiver unit: UTB-YWC (45/60)
UTY-TRHX (036/072/090/096)
- External power supply unit: UTZ-GXXA (036/072/090/096)
- WLAN adapter: UTY-TFSXZ1 (036/072/090/096)
- Silver Ion Filter: UTD-HFKA (036)
UTD-HFKB (45/60)

Dimensions

(Unit: mm)

Models: ARXC036/ARXC45/ARXC60

Models: ARXC072/ARXC090

Models: ARXC096

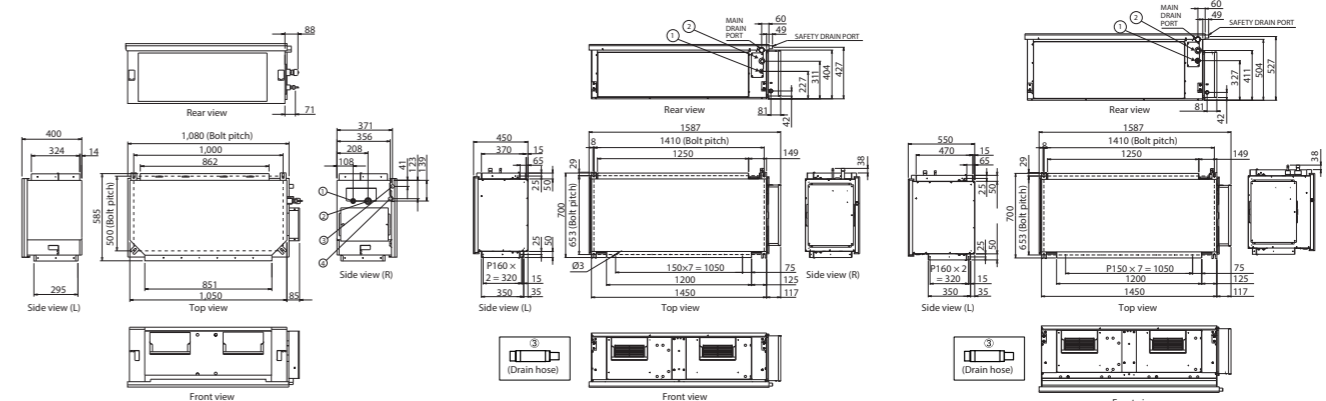

- ① Refrigerant pipe flare connection (Liquid)
- ② Refrigerant pipe flare connection (Gas)
- ③ Drain pipe connection (Safety drain pan)
- ④ Drain pipe connection (Main drain pan)

- ① Refrigerant pipe flare connection (Liquid)
- ② Refrigerant pipe flare connection (Gas)
- ③ Drain hose

- ① Refrigerant pipe flare connection (Liquid)
- ② Refrigerant pipe flare connection (Gas)
- ③ Drain hose

High Static Pressure Duct High-efficiency



High-volume airflow

High-volume airflow enables installation in places where an early exchange of air is required.

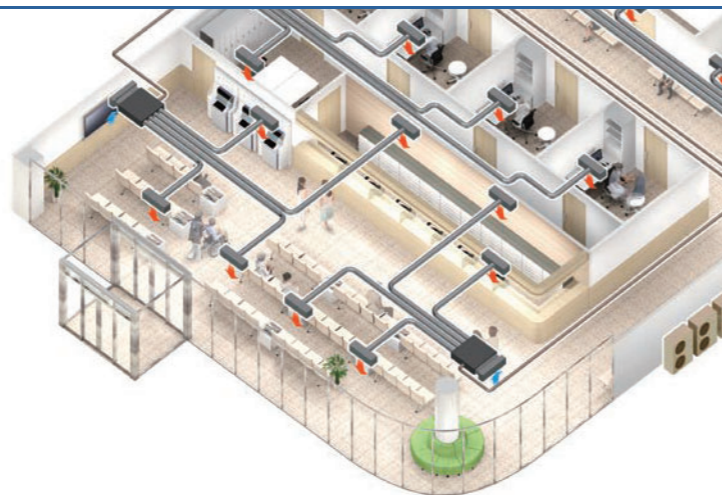
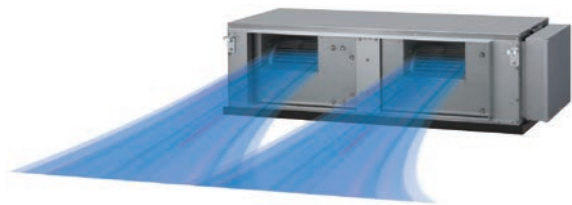

Wide range of static pressures

Static pressure range
50 to 250 Pa



Installation styles

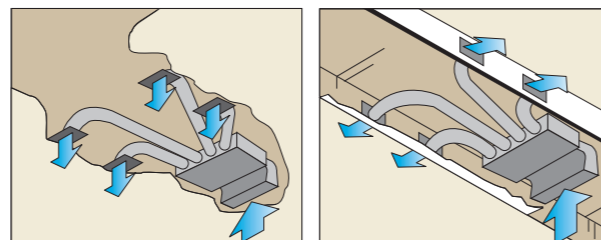

Model: ARXQ030GTAH * Production by order



Specifications

Model name			ARXQ030GTAH
Power source			Single phase, ~230 V, 50 Hz
Capacity	Cooling	kW	9.0
	Heating	kW	10.0
Input power			W
Airflow rate	High	m ³ /h	3,200
	Med	m ³ /h	—
	Low	m ³ /h	—
Static pressure range			Pa
Standard static pressure			50
Sound pressure level	High	dB(A)	40
	Med	dB(A)	—
	Low	dB(A)	—
Net Dimensions (H × W × D)			mm
Weight			kg (lbs)
Connection pipe diameter	Liquid	mm	9.52 (Flare)
	Gas	mm	15.88 (Flare)
Drain Hose Diameter (I.D./O.D.)			25/32

Note: Specifications are based on the following conditions:
Cooling: Indoor temperature of 27°CDB/19°CWB, and outdoor temperature of 35°CDB/24°CWB.
Heating: Indoor temperature of 20°CDB/15°CWB, and outdoor temperature of 7°CDB/6°CWB.
Pipe length: 7.5 m; Height difference between outdoor unit and indoor unit: 0 m. Voltage: 230 [V]
*High Static Pressure Duct High Efficiency can be connected to V-III Series and VR-IV Series.

Optional parts

Remote sensor unit: UTY-XSZX
IR receiver unit: UTY-TRHX

Dimensions

(Unit: mm)

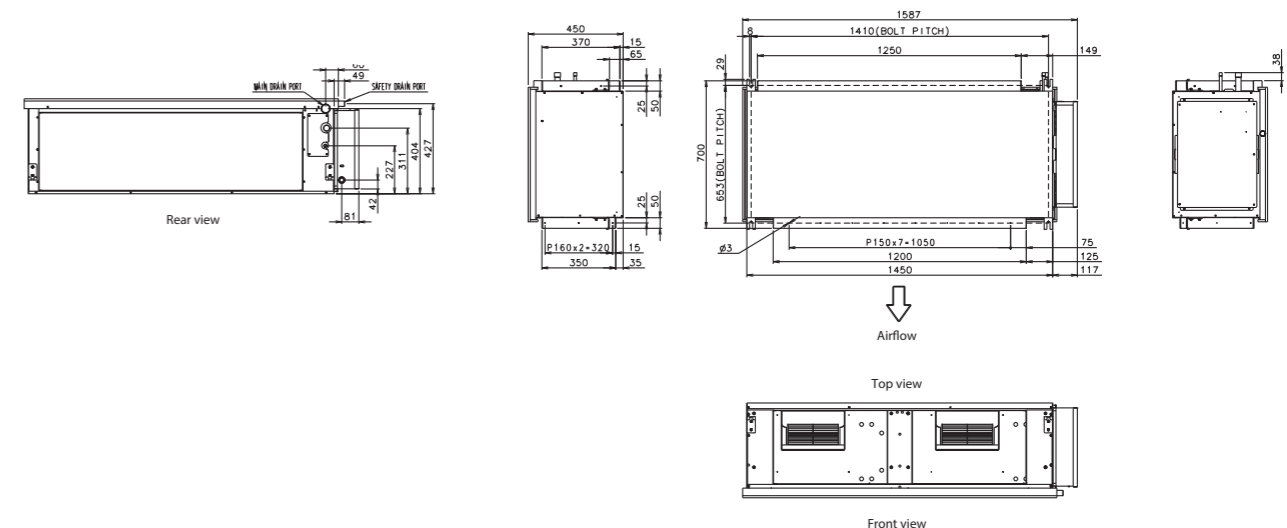

Compact floor



Model: AGYA004GCGH/AGYA007GCGH/AGYA009GCGH
 AGYA012GCGH/AGYA014GCGH
 [external EEV]
 AGYE004GCEH/AGYE007GCEH/AGYE009GCEH
 AGYE012GCEH/AGYE014GCEH



Specifications

Model name		AGYA004GCGH	AGYA007GCGH	AGYA009GCGH	AGYA012GCGH	AGYA014GCGH	AGYE004GCEH	AGYE007GCEH	AGYE009GCEH	AGYE012GCEH	AGYE014GCEH	
Power source		Single phase, ~230 V, 50 Hz						Single phase, ~230 V, 50 Hz				
Capacity	Cooling	1.1	2.2	2.8	3.6	4.0	1.1	2.2	2.8	3.6	4.0	
	Heating	1.3	2.8	3.2	4.0	4.5	1.3	2.8	3.2	4.0	4.5	
Input power		12/14	16	17	22	29	14	16	17	22	29	
Airflow rate	High	380/430	470	500	590	670	380/430	470	500	590	670	
	Med-High	350	420	450	520	590	350	420	450	520	590	
	Med	320	390	400	470	520	320	390	400	470	520	
	Med-Low	310	360	360	420	450	310	360	360	420	450	
	Low	280	330	330	390	390	280	330	330	390	390	
Sound pressure level	High	35/36	37	38	42	46	35/36	37	38	42	46	
	Med-High	33	35	36	39	42	33	35	36	39	42	
	Med	31	33	34	37	39	31	33	34	37	39	
	Med-Low	30	31	31	35	36	30	31	31	35	36	
	Low	28	29	29	33	33	28	29	29	33	33	
Quiet	22	22	22	30	30	22	22	22	30	30		
Net Dimensions (H × W × D)		mm 600 × 740 × 200						mm 600 × 740 × 200				
Weight		kg (lbs)	15.0 (33.0)	15.0 (33.0)	15.0 (33.0)	15.0 (33.0)	15.0 (33.0)	14.5 (32.0)	14.5 (32.0)	14.5 (32.0)	14.5 (32.0)	
Connection pipe diameter	Liquid (Flare)	mm	6.35	6.35	6.35	6.35	6.35	6.35	6.35	6.35	6.35	
	Gas (Flare)	mm	9.52	9.52	9.52	12.70	12.70	9.52	9.52	9.52	12.70	
Drain Hose Diameter (I.D./O.D.)		mm 13.8/15.8 to 16.7						mm 13.8/15.8 to 16.7				
EV kit (optional)								UTR-EV09XB		UTR-EV14XB		

2-fan and wide airflow

A 2-fan individual vertical airflow cools or warms the entire room comfortably.

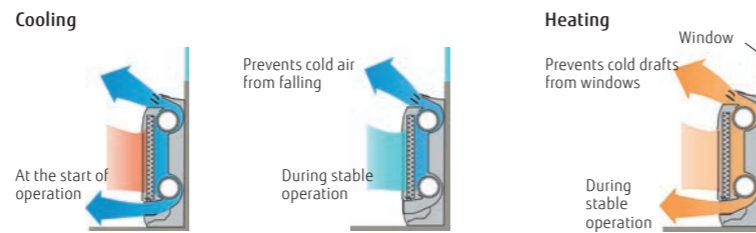

Flexible and easy installation

The compact and whole-surface suction design provides flexible installation options, including floor-standing, embedded, partially embedded, and wall-mounted installation to match the room layout.

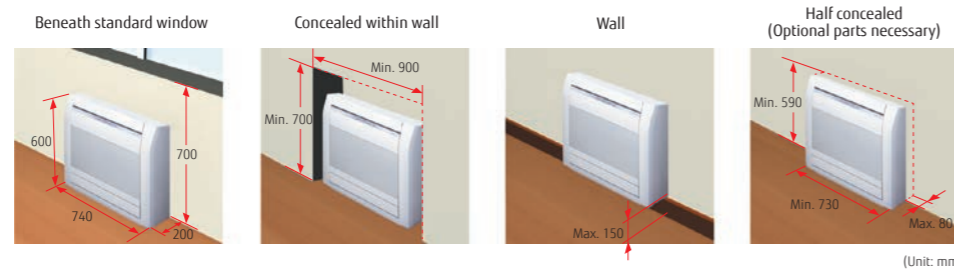

Quiet operation

6-fan speed control for quiet operation (via 2-wire controller)

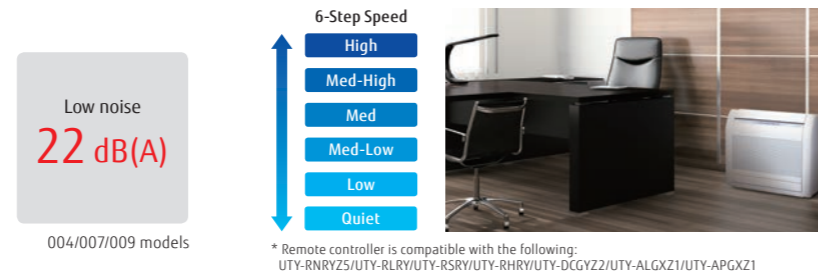

Flexible pipe connection enables draining and piping in 6 directions

The drain hose and pipe can be connected to the unit in the right, left, straight in depth, or downward direction.

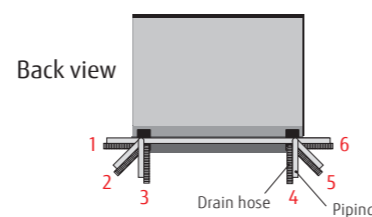

Optional parts

- Partially concealing kit: UTR-STA
- External power supply unit: UTZ-GXXA
- WLAN adapter: UTY-TFSXZ1
- Silver Ion Filter: UTR-FA03-5

Dimensions

(Unit: mm)

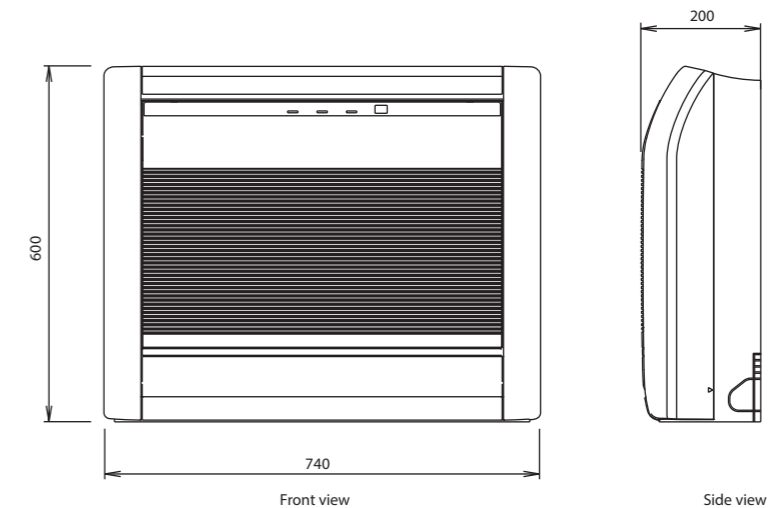

Ceiling



Model: ABYA030GTEH/ABYA036GTEH/ABYA045GTEH / ABYA054GTEH



Specifications

Model name		ABYA030GTEH	ABYA036GTEH	ABYA045GTEH	ABYA054GTEH
Power source		Single phase, ~230 V, 50 Hz			
Capacity	Cooling	9.0	11.2	12.5	14.0
	Heating	10.0	12.5	14.0	16.0
Input power		66	85	131	180
Airflow rate	High	1,630	1,690	2,010	2,270
	Med-High	1,520	1,560	1,840	2,070
	Med	1,420	1,450	1,690	1,860
	Med-Low	1,320	1,360	1,530	1,660
	Low	1,220	1,270	1,380	1,470
	Quiet	1,140	1,170	1,230	1,280
Sound pressure level	High	42	45	48	51
	Med-High	40	41	46	49
	Med	39	39	45	46
	Med-Low	37	38	41	43
	Low	35	36	38	40
	Quiet	33	34	35	36
Net Dimensions (H × W × D)		mm 240 × 1,660 × 700	240 × 1,660 × 700	240 × 1,660 × 700	240 × 1,660 × 700
Weight		kg (lbs) 46 (101)	48 (106)	48 (106)	48 (106)
Connection pipe diameter	Liquid (Flare)	9.52	9.52	9.52	9.52
	Gas (Flare)	15.88	15.88	15.88	15.88
Drain Hose Diameter (I.D./O.D.)		25/32			

Note: Specifications are subject to the following conditions:
 Cooling: Indoor temperature of 27°CDB/19°CWB, and outdoor temperature of 35°CDB/24°CWB.
 Heating: Indoor temperature of 20°CDB/15°CWB, and outdoor temperature of 7°CDB/6°CWB.
 Pipe length: 7.5 m; Height difference between outdoor unit and indoor unit: 0 m. Voltage: 230 [V]

Installation

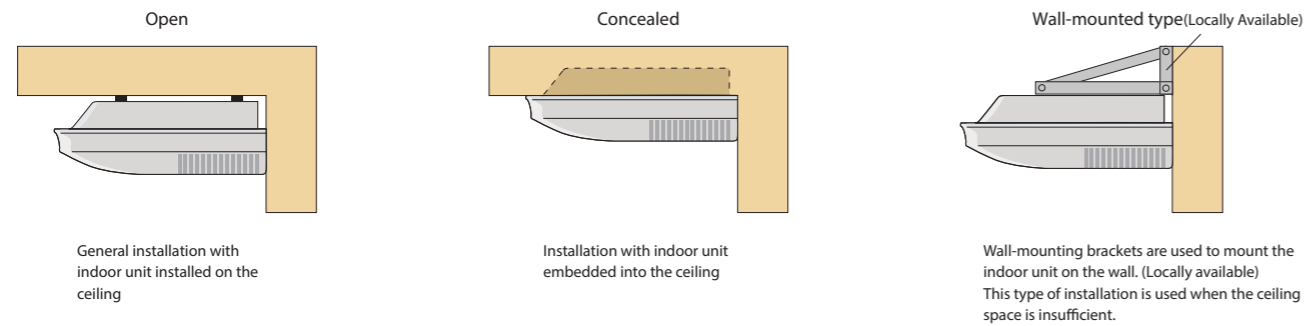

Double auto swing and wide airflow

Auto airflow direction and auto swing

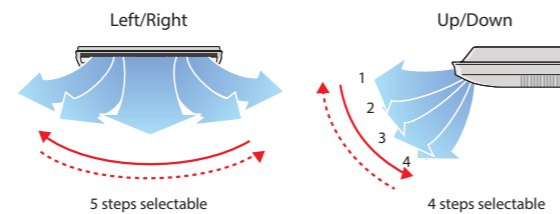

High-power DC fan motor

- High power
- Wide rotation range
- High-efficiency



Long airflow

Long airflow provides comfort in every corner of a large room.

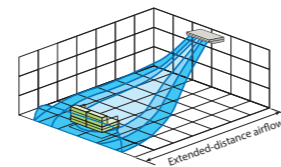

Fresh air intake

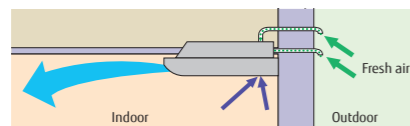

Slim & Compact Design

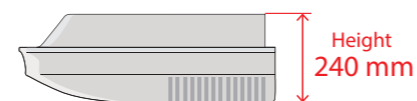

Optional parts

- Drain pump unit: UTR-DPB24T
- Flange: UTD-RF204
- External power supply unit: UTZ-GXXA
- WLAN adapter: UTY-TFSX21

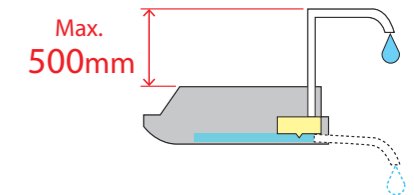

Dimensions

(Unit: mm)

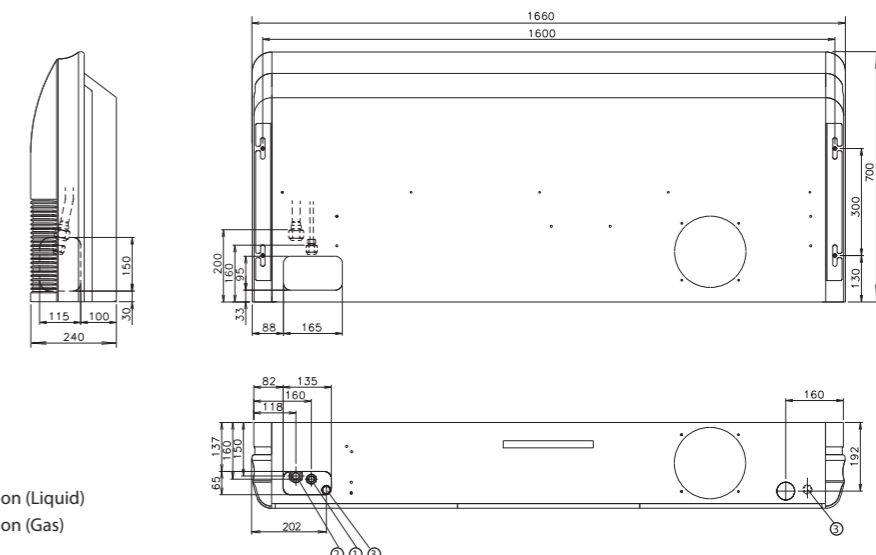

- ① Refrigerant pipe flare connection (Liquid)
- ② Refrigerant pipe flare connection (Gas)
- ③ Drain pipe connection

Wall-mounted type



Highly-efficiency, compact design

The 004-014 models share the same design. The high-density and large heat exchanger achieves a highly-efficiency and compact design. The compact body blends in well with conference rooms and offices, providing comfortable air conditioning.

High-density heat exchanger

Slim tube design: 5 mm
Greater heat-exchanging capacity is achieved through the use of a high-density heat exchanger and a sub-heat exchanger.

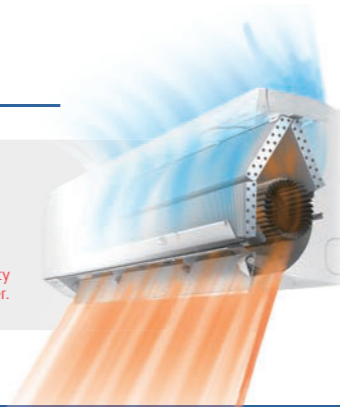

More comfortable airflow

The unique power diffuser provides comfortable air conditioning.

Heating

The vertical airflow provides powerful floor-level heating.

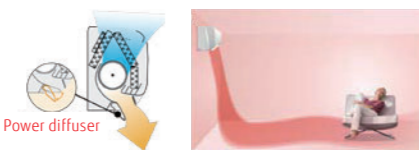

Cooling

The left/right airflow avoids blowing cool air directly at the occupants in a room.



Quiet operation & 6-Step Fan Speed Control

The airflow structure achieves significant noise reduction. Multistep airflow adjustment to suit the environment

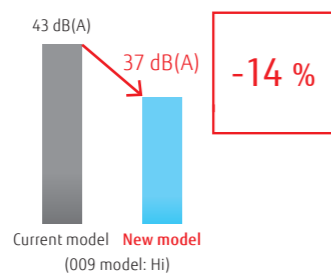

- 6-Step Speed
- High
- Med-High
- Med
- Med-Low
- Low
- Quiet

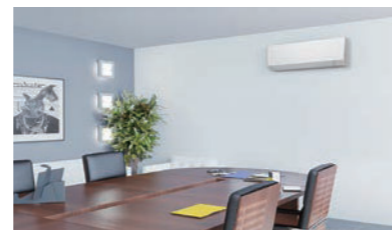

* Remote controller is compatible with the following:
UTY-RNRV25/UTY-RLRV/UTY-RSRV/UTY-RHRV/UTY-DCGY22/UTY-ALGX21/UTY-APGX21

The human sensor contributes to further energy savings.

Energy saving operation starts automatically by detecting the motion of a person. Two modes of save operation mode and stop mode can be selected.

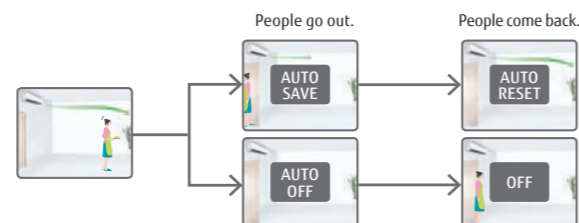

Model: ASYA004GCGH/ASYA007GCGH/ASYA009GCGH
ASYA012GCGH/ASYA014GCGH
[external EEV]
ASYE004GCEH/ASYE007GCEH/ASYE009GCEH
ASYE012GCEH/ASYE014GCEH



Specifications

Model name	ASYA004GCGH	ASYA007GCGH	ASYA009GCGH	ASYA012GCGH	ASYA014GCGH	ASYE004GCEH	ASYE007GCEH	ASYE009GCEH	ASYE012GCEH	ASYE014GCEH
Power source	Single phase, ~230 V, 50 Hz					Single phase, ~230 V, 50 Hz				
Capacity	Cooling	1.1	2.2	2.8	3.6	4.0	1.1	2.2	2.8	3.6
	Heating	1.3	2.8	3.2	4.0	4.5	1.3	2.8	3.2	4.0
Input power	W									
Airflow rate	High	450	550	610	690	800	450	550	610	690
	Med-High	430	510	560	610	740	430	510	560	610
	Med	400	470	510	560	680	400	470	510	560
	Med-Low	380	410	440	530	610	380	410	440	530
	Low	360	360	360	470	550	360	360	360	470
	Quiet	310	310	310	330	330	310	310	310	330
Sound pressure level	High	31	34	37	40	44	31	35	43	44
	Med-High	30	32	35	37	42	30	32	38	42
	Med	28	30	32	35	40	28	30	34	40
	Med-Low	27	28	29	33	37	27	27	29	33
	Low	26	26	26	30	34	26	24	24	30
	Quiet	22	22	22	24	24	22	22	22	24
Net Dimensions (H x W x D)	mm 268 x 840 x 203					mm 268 x 840 x 203				
Weight	kg (lbs)									
Connection pipe diameter	Liquid (Flare)	6.35	6.35	6.35	6.35	6.35	6.35	6.35	6.35	6.35
	Gas (Flare)	9.52	9.52	9.52	12.70	12.70	9.52	9.52	9.52	12.70
Drain Hose Diameter (I.D./O.D.)	mm 13.8/15.8 to 16.7					mm 13.8/15.8 to 16.7				
EV kit (optional)	-					UTR-EV09XB			UTR-EV14XB	

Note: Specifications are subject to the following conditions:
Cooling: Indoor temperature of 27°CDB/19°CWB, and outdoor temperature of 35°CDB/24°CWB.
Heating: Indoor temperature of 20°CDB/15°CWB, and outdoor temperature of 7°CDB/6°CWB.
Pipe length: 7.5 m; Height difference between outdoor unit and indoor unit: 0 m. Voltage: 230 [V]
When connecting ASY*004G**H, ASY*007G**H, ASY*009G**H to an outdoor unit other than the outdoor unit of the J-IVL Series, the gas pipe diameter should be Ø12.70 mm.

Optional parts

External power supply unit: UTZ-GXXA
WLAN adapter: UTY-TFSXZ1
Silver Ion Filter: UTR-FA16-5

Dimensions

(Unit: mm)

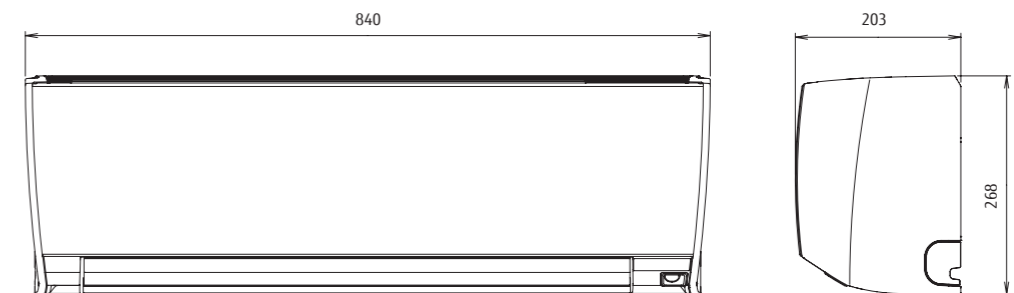

Wall-mounted type



Powerful & Comfort airflow

Powerful Airflow

(ASYA030GTEH)

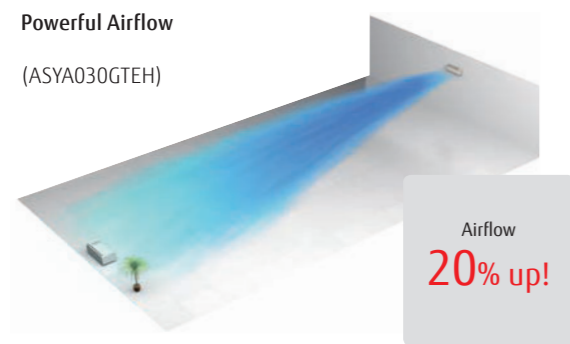

Power diffuser

(ASYA18/24GBCH)

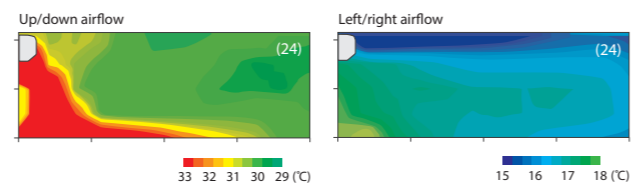

Human sensor (ASYA030/034GTEH only)

The Human sensor detects the movements of people to suppress operation when people are in the room, automatically reducing power consumption to save electricity bills.

* UTY-RNRYZ5 Wired remote controller with touch panel and UTY-DCGYZ2 Central remote controller only



6-step fan speed control for quiet operation

The airflow structure achieves significant noise reduction. A 6-step sound level setting allows for multiple-step silent operations.

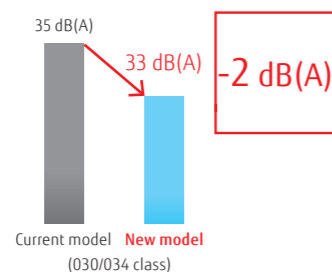

- 6-Step Speed
- High
- Med-High
- Med
- Med-Low
- Low
- Quiet



* Remote controller is compatible with the following: UTY-RNRYZ5/UTY-RLRY/UTY-RSRY/UTY-RHRY/UTY-DCGYZ2/UTY-ALGXZ1/UTY-APGXZ1

Model: ASYA18GBCH/ASYA24GBCH
ASYA030GTEH/ASYA034GTEH



ASYA18/24GBCH



ASYA030/034GTEH

Specifications

Model name		ASYA18GBCH	ASYA24GBCH	ASYA030GTEH	ASYA034GTEH
Power source		Single phase, ~230 V, 50 Hz			
Capacity	Cooling	5.6	7.1	9.0	10.0
	Heating	6.3	8.0	10.0	11.2
Input power		32	60	74	103
Airflow rate	High	840	1,100	1,440	1,620/1,520
	Med-High	-	-	1,200	1,300
	Med	770	910	1,050	1,120
	Med-Low	-	-	940	980
	Low	690	730	890	890
	Quiet	-	-	700	700
Sound pressure level	High	41	48	53	55/54
	Med-High	-	-	49	51
	Med	39	43	45	47
	Med-Low	-	-	42	43
	Low	35	35	39	39
	Quiet	-	-	33	33
Net Dimensions (H × W × D)		mm 320 × 998 × 238	320 × 998 × 238	340 × 1,150 × 280	340 × 1,150 × 280
Weight		kg (lbs) 15 (33)	15 (33)	18 (40)	18 (40)
Connection pipe diameter	Liquid (Flare)	6.35	9.52	9.52	9.52
	Gas (Flare)	12.70	15.88	15.88	15.88
Drain Hose Diameter (I.D./O.D.)		12/16		13.8/15.8 to 16.7	

Note: Specifications are subject to the following conditions:
Cooling: Indoor temperature of 27°CDB/19°CWB, and outdoor temperature of 35°CDB/24°CWB.
Heating: Indoor temperature of 20°CDB/15°CWB, and outdoor temperature of 7°CDB/6°CWB.
Pipe length: 7.5 m; Height difference between outdoor unit and indoor unit: 0 m. Voltage: 230 [V].
When connecting ASYA18GBCH to an outdoor unit other than the outdoor unit of the J-VL Series, the pipe diameter should be Ø9.52/Ø15.88 mm (Liquid/Gas).

Optional parts

External power supply unit: UTZ-GXXA (030/034)
WLAN adapter: UTY-TFSXZ1 (030/034)
Silver Ion Filter: UTR-FA13-3

Dimensions

(Unit: mm)

Models: ASYA18/ASYA24

Models: ASYA030/ASYA034

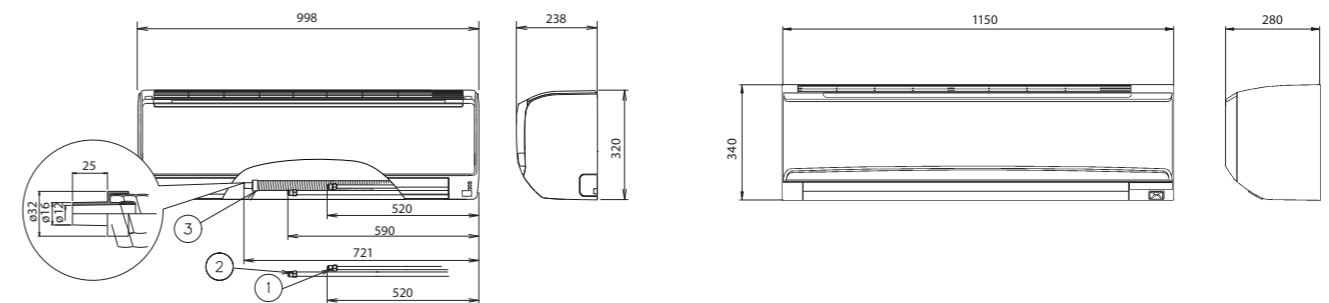

- ① Refrigerant pipe flare connection (Liquid)
- ② Refrigerant pipe flare connection (Gas)
- ③ Drain pipe connection

Residential, Commercial & Light Commercial VENTILATION

VENTILATION Lineup

- Vn-002 Energy Recovery Ventilator
- Vn-004 DX kit for Air handling applications
 - for VRF Outdoor unit
- Vn-006 DX kit for Air handling applications
 - for Single Split Outdoor Units
- Vn-008 AIR HANDLING UNIT

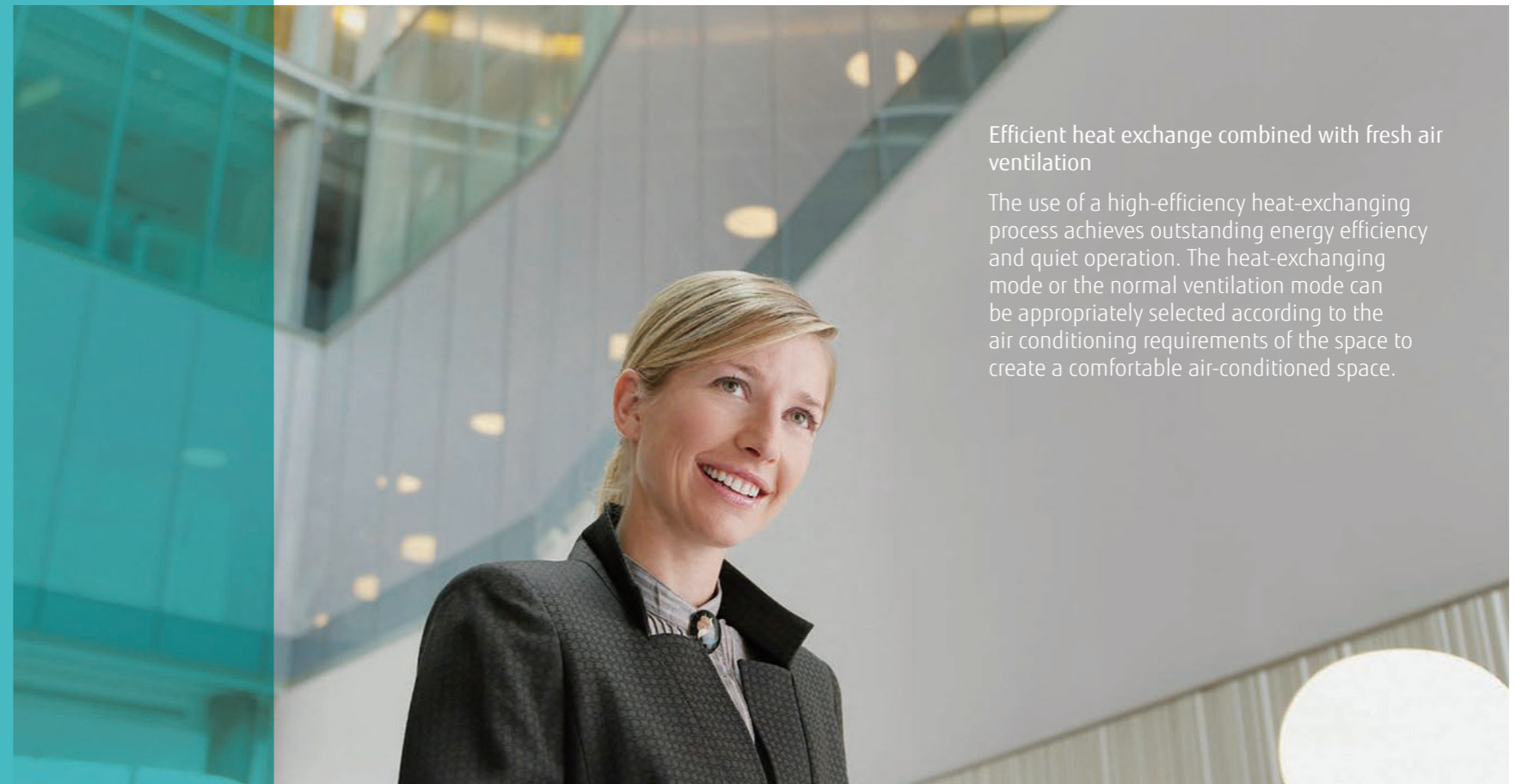











Efficient heat exchange combined with fresh air ventilation

The use of a high-efficiency heat-exchanging process achieves outstanding energy efficiency and quiet operation. The heat-exchanging mode or the normal ventilation mode can be appropriately selected according to the air conditioning requirements of the space to create a comfortable air-conditioned space.

Lineup

Airflow rate (m ³ /h)	250	350	500	800	1000
Energy Recovery Ventilator	 UTZ-BD025C	 UTZ-BD035C	 UTZ-BD050C	 UTZ-BD080C	 UTZ-BD100C

Connectable capacity class (kW)	5.0	6.3	8.0	10.0	12.5	14.0	20.0	25.0	40.0	50.0
DX kit for Air handling applications for VRF Outdoor unit	 EEV unit UTP-VX30A	 Control unit UTY-VDGX	 EEV unit UTP-VX60A	 Control unit UTY-VDGX	 EEV unit UTP-VX90A	 Control unit UTY-VDGX	 EEV unit UTP-VX90A	 Control unit UTY-VDGX	 EEV unit UTP-VX90A × 2	 Control unit UTY-VDGX

Connectable capacity class (kW)	3.5 - 22.0
DX-kit for Air handling applications for VRF Outdoor unit	 UTY-XDZX

Connectable capacity class (kW)	25 - 96
Air handling unit	 AHYA/AHYB/AHYC/AHYD/AHYE

Energy Recovery Ventilator



The energy recovery ventilator unit provides energy efficiency for comfort and improved savings.

Heat exchange ventilation and normal ventilation

Heat exchange ventilation

When a room is cooled or heated, the exhausted cooling or heating energy is recovered by heat exchange ventilation.

Normal ventilation

Used when the indoor space does not require cooling or heating, i.e., when there is little temperature difference between the indoor and outdoor environments.

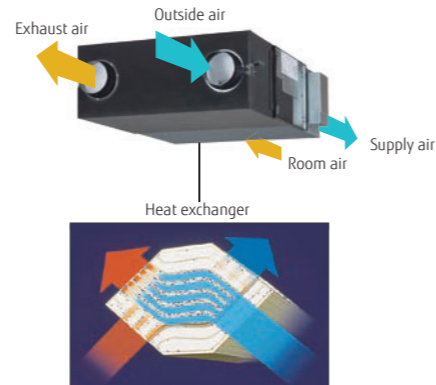

A high-efficiency counter-flow heat-exchanging element is used in the setup.

Energy efficiency and ecology

The use of a counter-flow heat-exchanging element, designed to recover up to 77% of heat from the outgoing air, significantly reduces energy consumption. The air conditioning load is reduced by approximately 20%, which results in substantial savings in energy cost.

Comparison of heat-exchanging elements

Air flows in a straight line through a crossflow element. In contrast, air flows for a longer time (a longer distance) through a counter-flow element to achieve more consistent heat-exchanging performance.

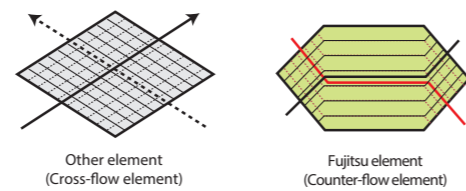

Quiet operation

Significantly lower noise levels are achieved by reducing pressure loss.

25.5dB
(UTZ-BD035C)

Extended range of external static pressure

The use of a powerful fan motor improves the external static pressure. This allows it to be installed in a variety of buildings.

Slim design for easier installation

The use of a counter-flow heat-exchanging element made it possible to design a quieter, slimmer unit.



Reverse-mountable direct air supply and exhaust system

Simplifies the duct design, due to its straight ducts for air supply and exhaust. Since each unit can be mounted facing opposite directions, only one inspection hole is needed for two units. This makes duct work easier and more flexible.

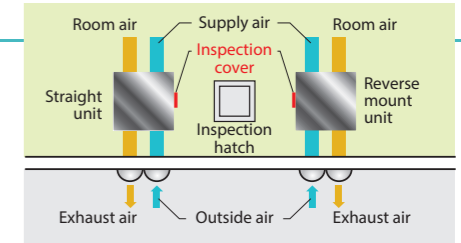

Simple remote operation

Easy operation with connected liquid crystal switch

- Power On/Off
- Air volume High/Low
- Heat exchange ventilation and normal ventilation
- On/Off Timer
- Clean filter display



Model: UTZ-BD025C/UTZ-BD035C/UTZ-BD050C/UTZ-BD080C/UTZ-BD100C



Specifications

Rated flow rate	250 m ³ /h		350 m ³ /h		500 m ³ /h		800 m ³ /h		1000 m ³ /h	
Model name	UTZ-BD025C		UTZ-BD035C		UTZ-BD050C		UTZ-BD080C		UTZ-BD100C	
Power source	Single phase, ~220 to 240 V, 50 Hz									
Heat Exchange Ventilation	Input power	(Extra high)/High/Low	W	128/123/96	190/185/168	289/225/185	418/378/295	464/432/311		
	Airflow rate	(Extra high)/High/Low	m ³ /h	250/25/190	350/350/240	500/500/440	800/800/630	1,000/1,000/700		
	External static pressure	(Extra high)/High/Low	Pa	105/95/45	140/60/45	120/60/35	140/110/55	105/80/75		
	Temperature exchange efficiency	(Extra high)/High/Low	%	75/75/77	75/75/78	75/75/76	75/75/76	75/75/79		
	Energy exchange efficiency cooling	(Extra high)/High/Low	%	63/63/65	66/66/71	62/62/64	65/65/68	65/65/70		
Normal Ventilation	Input power	(Extra high)/High/Low	W	128/123/96	190/185/168	289/225/185	418/378/295	464/432/311		
	Airflow rate	(Extra high)/High/Low	m ³ /h	250/25/190	350/350/240	500/500/440	800/800/630	1,000/1,000/700		
	External static pressure	(Extra high)/High/Low	Pa	105/95/45	140/60/45	120/60/35	140/110/55	105/80/75		
	Temperature exchange efficiency heating	(Extra high)/High/Low	%	70/70/72	69/69/73	67/67/69	71/71/74	71/71/76		
	Energy exchange efficiency heat pump	(Extra high)/High/Low	%	70/70/72	69/69/73	67/67/69	71/71/74	71/71/76		
Sound pressure level	(Extra high)/High/Low	dB*	31.5/30.5/26.5	33.0/31.0/25.5	37.5/35.5/32.5	37.5/37.0/34.5	38.5/37.5/36.5			
Dimensions	W × D × H	mm	882 × 599 × 270	1,050 × 804 × 317	1,090 × 904 × 317	1,322 × 884 × 388	1,322 × 1,134 × 388			
Weight		kg	29	49	57	71	83			
Outlet duct diameter		mm	150	150	200	250	250			
Operating range		°C	-10 to 40	-10 to 40	-10 to 40	-10 to 40	-10 to 40			
Maximum humidity		%	85	85	85	85	85			

* Noise level measured 1.5 m below the center of the unit

Dimensions

(Unit: mm)

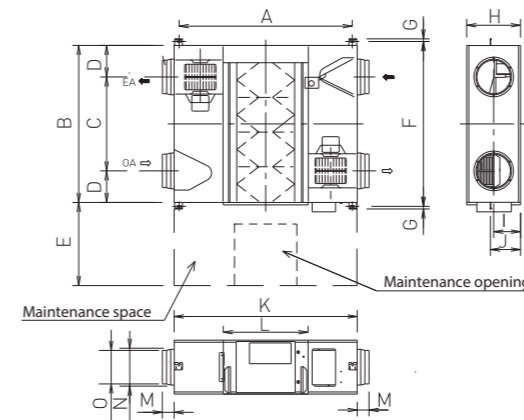

	UTZ-BD025C	UTZ-BD035C	UTZ-BD050C	UTZ-BD080C	UTZ-BD100C
A	810	978	1,018	1,250	1,250
B	599	804	904	884	1,134
C	315	580	640	428	678
D	142	112	132	228	228
E	600	600	600	600	600
F	655	860	960	940	1,190
G	19	19	19	19	19
H	270	317	317	388	388
I	135	159	159	194	194
J	159	182	182	218	218
K	882	1,050	1,090	1,322	1,322
L	414	470	470	612	612
M	95	70	70	85	85
N	Ø164	Ø164	Ø210	Ø258	Ø258
O	Ø144	Ø144	Ø194	Ø242	Ø242

DX kit for Air handling applications for VRF Outdoor unit



With these kits, air handling units (AHUs) and fan coil units (FCUs) from other manufacturers can be incorporated into Fujitsu General VRF systems, or one AHU can be connected to one Fujitsu General VRF dedicated outdoor unit to control outdoor air ventilation and room temperatures.

Multiple temperature sensors optimally control an Air handling unit and a fan coil unit.

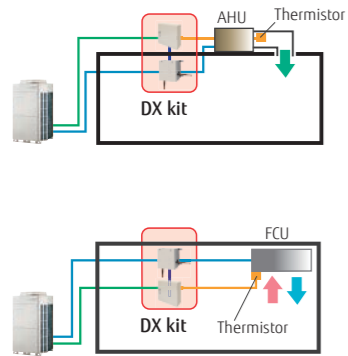

When connected to an Air handling unit, the temperature of supply air is controlled by a discharge air sensor.

When connected to a fan coil unit, the room temperature is controlled by the discharge air sensor.

Application as part of a VRF system

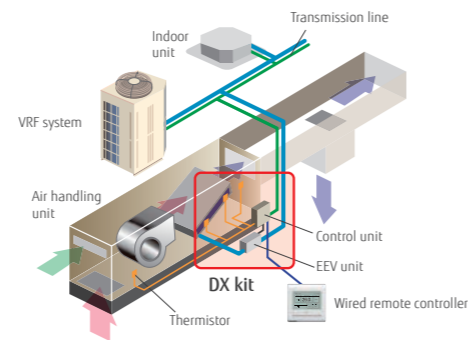

Supports a wide range of capacity classes

- Two EEV units can be connected in parallel to large-capacity units of up to 20 HP (50 kW). (UTP-LX180A separation tube required)
- Connectable capacity range: 5 kW to 50 kW

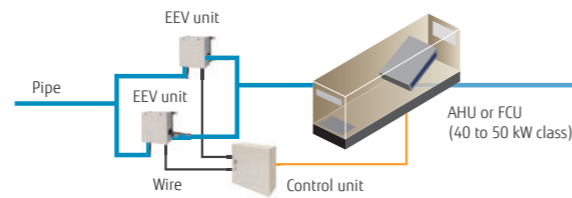

A variety of control options that meet application requirements

Central control enabled by our VRF controllers or central management controllers

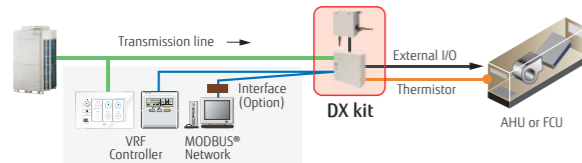

Central control from external controllers

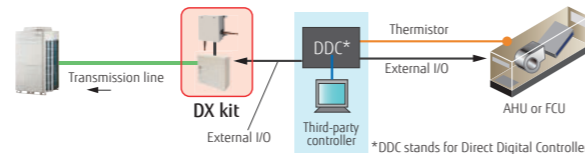

*DDC stands for Direct Digital Controller

Summary of functions

Inputs

- On/Off
- Setting temperature
- Capacity demand
- Heating/Cooling operation modes
- Fault information

Outputs

- On/Off indication
- Fan On/Off indication
- Thermostat On/Off indication
- Defrost indication
- Fault indication

MODBUS® Control

Can be controlled via a MODBUS®-enabled BMS using an optional interface.

Installation requirements

- Connectable VRF Series: All VRF Series
- Capacity range of connectable DX kit systems with outdoor units: 50 to 100% of capacity
- Capacity range of connectable DX kit systems with indoor units: 30% or less of capacity
- Max. pipe length from a control unit: 10 m
- Max. pipe length between EEV unit and indoor unit: 5 m
- A control unit (IP54 class) and an EEV unit can be installed outdoors.

Connectable capacity

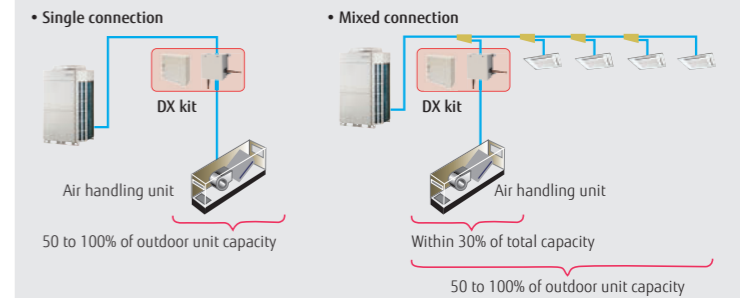

Pipe and wire length

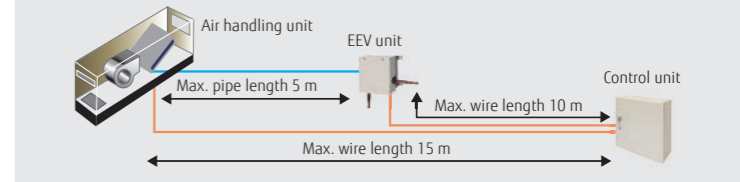

Optional separation tube to connect two EEV units: UTP-LX180A



Control unit: UTY-VDGX EEV unit: UTP-VX30A/UTP-VX60A/UTP-VX90A

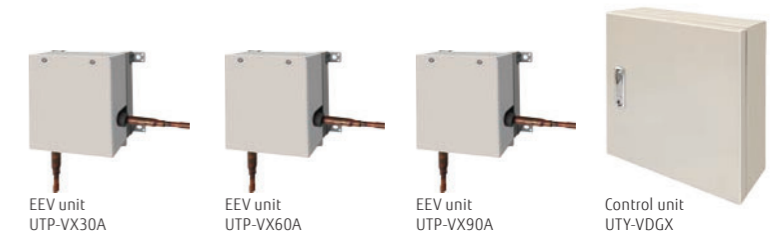

Specifications

Connectable capacity class		5.0 kW	6.3 kW	8.0 kW	10.0 kW	12.5 kW	14.0 kW	20.0 kW	25.0 kW	40.0 kW	50.0 kW
Capacity	Cooling	5.6	6.3	8.0	10.0	12.5	14.0	22.4	25.0	40.0	50.4
	Heating	6.3	7.1	9.0	11.2	14.0	16.0	25.0	28.0	45.0	56.5

Control unit		UTY-VDGX			
Power source		230/1/50			
Dimensions (H × W × D)	mm	400 × 400 × 120			

EEV unit		UTP-VX30A	UTP-VX60A	UTP-VX90A	UTP-VX90A × 2
Connection pipe diameter (Liquid)	mm	Ø9.53	Ø12.70	Ø12.70	Ø12.70
Dimensions (H × W × D)	mm	160 × 220 × 90			

Note: Specifications are based on the following conditions.
Cooling: Indoor temperature of 27°CDB/19°CWB, and outdoor temperature of 35°CDB/24°CWB.
Heating: Indoor temperature of 20°CDB/15°CWB, and outdoor temperature of 7°CDB/6°CWB.
Pipe length: 7.5 m Voltage: 230 [V].

DX kit for Air handling applications for Single Split Outdoor Units



With this kit, other manufacturers' Air handling units (AHUs) and fan coil units (FCUs) can be incorporated into Fujitsu General Split outdoor units.

Flexible connectivity

This kit allows connections to third-party equipment. This control unit can also be used in conjunction with Fujitsu General single-split outdoor units, providing a perfect solution when a stand-alone Air handling unit is needed.

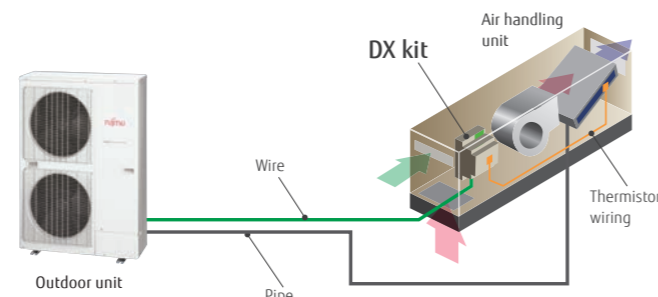

Supports a wide range of capacity classes

Capable of connecting large capacities in the range of 3.5 kW to 22.0 kW (Nominal)



Mobile devices allow for operation from anywhere

Can be operated and managed remotely using your smartphone or tablet.



Summary of functions

Inputs

- On/Off
- Heating/Cooling operation modes
- Capacity demand (analogue 0 to 10 V)
- Heat exchanger temperature

Outputs

- Status of Compressor, Defrost, and Errors (Potential free relays)
- Status indicator with LED

Wireless LAN Control

Wireless LAN control through cloud connectivity enables secure remote monitoring and control from anywhere.

Easy installation

- Compact DIN rail mountable enclosure for easy installation
- No expansion device required
- No separate external power supply required

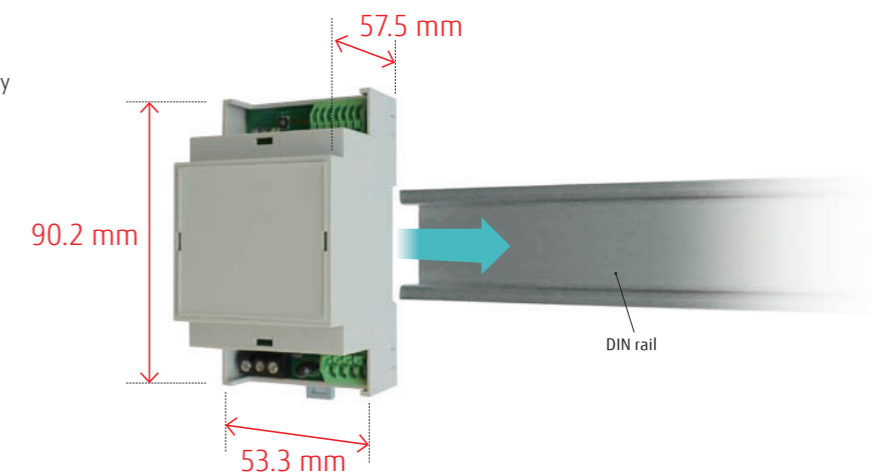

Model: UTY-XDZX



Specifications

BTU	12	14	18	24	30	36	45	54	60	72	90	
Capacity (Nominal)	Cooling	3.5	4.3	5.2	6.8	8.5	9.4	12.1	13.3	15.0	19.0	22.0
	Heating	4.1	5.0	6.0	7.8	10.0	10.8	13.3	15.8	18.0	22.4	27.0
Model name		UTY-XDZX										
Power source		230/1/50										
Dimensions (H × W × D)		90.2 × 53.3 × 57.5										
Weight		110										

Note: Specifications are based on the following conditions.
Cooling: Indoor temperature of 27°CDB/19°CWB, and outdoor temperature of 35°CDB/24°CWB.
Heating: Indoor temperature of 20°CDB/(15°CWB), and outdoor temperature of 7°CDB/6°CWB.
Pipe length: 5.0 m Voltage: 230 [V].



Light Commercial & Commercial AIR HANDLING UNIT

- Vn-010 System Overview
- Vn-012 AIRSTAGE™ Lineup
- Vn-014 Air Handling Units Overview
- Vn-016 Features
 - Structure
 - Filtration
 - Thermal Exchange Sections
 - Fan Section
 - Humidifier
 - Heat Recovery Section
- Vn-022 Dimensions
- Vn-025 Loose Accessories
- Vn-026 Total Pressure Drop
- Vn-027 Fan Characteristic Curves
- Vn-030 Specifications
- Vn-032 Control System
 - AHU Controller
 - System controller (System controller Lite)



FUJITSU GENERAL (Euro) GmbH participates in the ECP program for AHU. Check ongoing validity of certificate: www.eurovent-certification.com



System Overview

Air handling applications available in Fujitsu General AIRSTAGE™ system realize high energy efficiency and superior comfort to flexibly adapt to the stringent air conditioning requirements and installation conditions of a wide variety of facilities.

The system consists of AIRSTAGE™ outdoor units of 10 to 54 HP and thermal ventilation and air conditioning units for civil and industrial use, covering airflow ranges from 4,300 to 18,100 m³/h with cooling capacities from 25 to 96 kW.

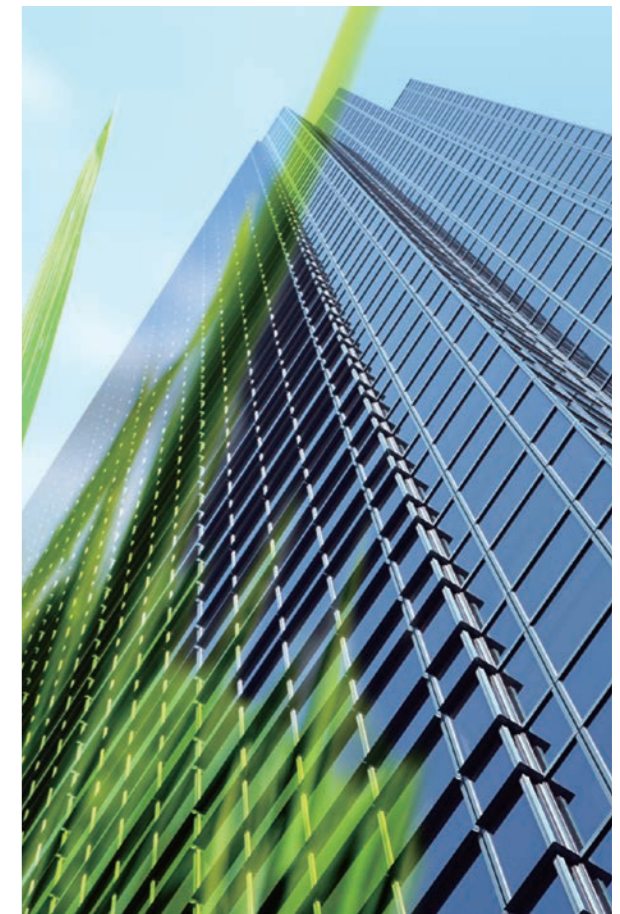

Advantages of the System

Full comfort

This system provides clean, Fresh air with advanced filtration and balanced temperatures to increase comfort and air quality in a building.

Simple design, easy installation

Equipped with a DX kit (Electronic Expansion Valve and PCB), AHU facilitates installation design. The AHU model can be easily configured using the Selection Software.







































Total solution concept

Integrating an AHU into the building climate control system simplifies the design and installation processes based on a single, common technology. From project follow-up through to installation, commissioning, and maintenance, all procedures are simplified. The above features allow a single installation company to carry out design, installation, and commissioning.

- For AHU control: AHU controller (Only For AHU)
 * For mixed connection control: System controller, or third-party controller with MODBUS® converter

AIRSTAGE™ Lineup

Fujitsu General's AIRSTAGE™ series is a multi-type air conditioning system for buildings tailored to the scale and application of the building.

Capacity (kW)	28.0	33.5	40.0	45.0	50.4	55.9	61.5	67.0	73.5	78.5	85.0	90.0	95.0	100.5	107.0	112.0	118.5	123.5	130.0	135.0	140.0	145.0	150.0	
HP	10	12	14	16	18	20	22	24	26	28	30	32	34	36	38	40	42	44	46	48	50	52	54	
J-IVL Series	 AJY090 LELBH	 AJY108 LELBH	 AJY126 LELBH	 AJY144 LELBH	 AJY162 LELBH																			
V-III Series Heat Pump	Space Saving	 AJY090 LALBH	 AJY108 LALBH	 AJY126 LALBH	 AJY144 LALBH	 AJY162 LALBH	 AJY180 LALBH	 AJY198 LALBH	 AJY216 LALBH	 AJY234 LALBH	 AJY252 LALBH	 AJY270 LALBH	 AJY288 LALBH	 AJY306 LALBH	 AJY324 LALBH	 AJY342 LALBH	 AJY360 LALBH	 AJY378 LALBH	 AJY396 LALBH	 AJY414 LALBH	 AJY432 LALBH	 AJY450 LALBH	 AJY468 LALBH	 AJY486 LALBH
	Energy Efficiency				 AJY144 LALBHH	 AJY162 LALBHH	 AJY180 LALBHH	 AJY216 LALBHH	 AJY234 LALBHH	 AJY252 LALBHH	 AJY270 LALBHH		 AJY288 LALBHH	 AJY306 LALBHH	 AJY324 LALBHH	 AJY342 LALBHH	 AJY360 LALBHH	 AJY378 LALBHH	 AJY396 LALBHH	 AJY414 LALBHH				
Set Model																								



AIRSTAGE™ J-IVL
for Small Offices

Fujitsu General provides air conditioning systems for a wide range of applications, from residences, small offices, hotels, to large retailers.



AIRSTAGE™ V-III
for Large Office

Smart, cutting-edge design Available in a wide range of models from 10 to 54 HP in 2 HP increments, with the capacity ratio of indoor units connectable up to 100%.

Air handling units Overview



The Air handling unit (AHU) is designed to be connected with AIRSTAGE™ series outdoor units for thermal ventilation and air conditioning of civil and industrial buildings. With airflow rates ranging from 4,300 to 18,100 m³/h and cooling capacities from 25 to 96 kW, a variety of models and multiple additional modules are available to meet diverse installation needs.

The AHU is made of extruded aluminum profiles and nylon angle bars. The "sandwich-type" double-skin panels (50 mm thick), made of surface coating pre-painted galvanized sheets and high-density polyurethane foam insulation, are fixed to the unit by an aluminum snap-in locking system.

The AHU fan section in the EC inverter Plug Fans provides constant airflow and constant available static pressure with an automatic control system. An electronic device with a pressure sensor mounted in the system and a control sensor on the EC inverter Plug Fans adjust the airflow rate and the available static pressure to keep the airflow constant.

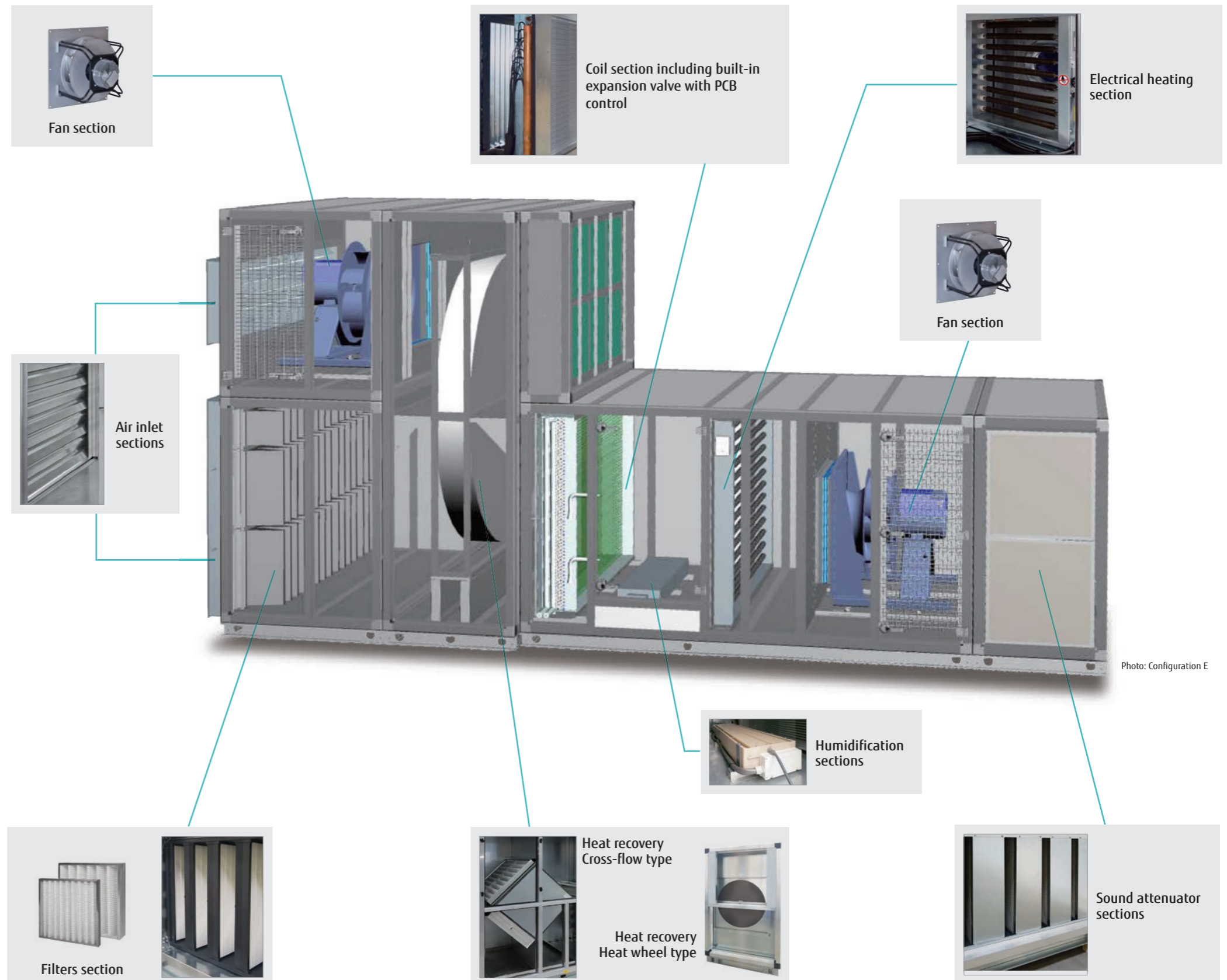

Photo: Configuration E

5 configurations are available

Configuration A
In line with Front damper
 For fresh air operation up to 100% external air

Configuration B
In line with Top inlet damper
 For fresh air operation up to 100% external air

Configuration C
In line with Inlet mixing box
 For fresh air operation up to 20% external air

Configuration D
Double deck with Cross-flow heat exchanger

Configuration E
Double deck with heat wheel

Feature



Structure

Section of extruded profile 62 × 62 mm (SNAP-IN system)

- The Air handling units are manufactured with a bearing framework and sandwich paneling.
- The frame is made of extruded anti-corrosive aluminum alloy profile, AlMgSi 0.5- UNI 9006/1.

Mechanical characteristics of extruded aluminium alloy

Denomination	Specific weight (kg/dm ³)	Unitary load of traction break R (kg/mm ²)	Yielding load S (0,2) (kg/mm ²)	Stretch (%)	Brinell hardness (kg/mm ²)
ANTICORODAL 050 UNI 9006/1 EX UNI 3569 (6060) ISO - Al Mg Si 0.5	2,70	20 ÷ 23	16 ÷ 20	12 ÷ 15	60 ÷ 70

Profile

- Fujitsu General's proprietary bearing has an actual size of 62 × 62 mm and an aluminum locking panel system (SNAP-IN system). This system enables uniform tightness of the panels that has not been achieved with the previous self-drilling screw fasteners, and thus ensures a degree of adhesion in excess of 2,500 Pa (10 in.W.G.). This profile, with no internal or external screws, provides a stronger and more beautiful appearance.
- The actual size of the panel used is 50 mm, due to the dimensions of the profile.
- In addition, the profile has no external sharp edges as prescribed by safety and accident prevention guidelines.
- The AHU is certified as meeting the most stringent performance standards.



- Fujitsu General units and all the internal components comply with ErP EcoDesign Directive 2018 Lot 6.
- Fujitsu General units comply with the European Standards UNE EN 1886 with respect to thermal and mechanical performances.

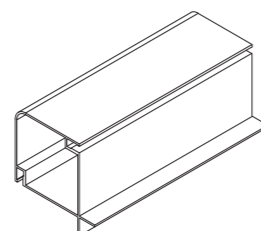
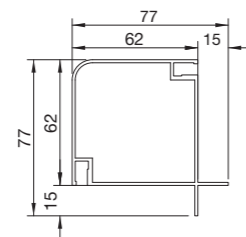

(Unit: mm)

Paneling

The panels are a double-skin sandwich type made of galvanized steel, with polyurethane foam insulation of a minimum density of 45 kg/m³ and an actual thickness of 50 mm.

The composition of the panel is as follows:

Inner skin: hot-dip galvanized sheet (galvanization thickness of not less than 140 g/m²), 5/10 mm thick

Insulation: rigid polyurethane foam (minimum density of 45 kg/m³, thermal conductivity 0.018 ÷ 0.024 w/m²•°C)

Outer skin: hot-dip, pre-painted galvanized sheet (galvanizing thickness of not less than 140 g/m²), 6/10 mm thick

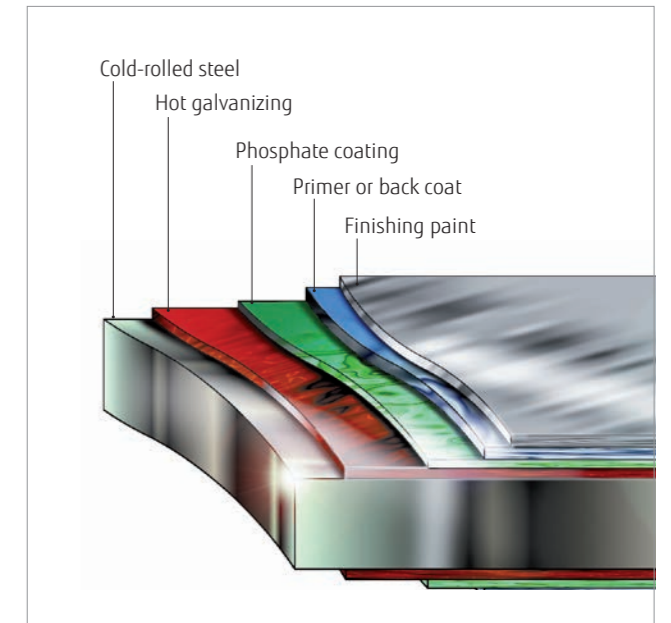

PRE-PAINTED GALVANIZED STEEL SHEET

Features of steel sheets

Hot-dipped galvanized steel sheet Fe P02 GZ 140 UNI EN 10142 with galvanization of not less than 140 g/m², 6/10 mm thick

Pre-painted steel sheet, 6/10 mm thick, with base support made of hot-dip galvanized steel with galvanization of not less than 140 g/m² Euronorm 142-79, a white-grey coating with excellent weather resistance. The protective system consists of a dry film of 25 µm on the exposed skin, and of a dry film of 5 µm on the non-exposed skin.

Film hardness: F on the Koh-i-Noor scale

Other chemical and physical properties:

- Resistance to salt spray exceeding 250 hours
- Resistance exceeding 1,000 hours in 100% relative humidity (ASTM D 714)
- Film resistance to cleaving and adhesion after bending (ECCA T7).

The exposed surface of the steel plate is covered with a self-adhesive PVC film to prevent damage during the manufacturing process and transportation.

Base frame

The bearing base frame is made of galvanized steel, the outline of which is pressure bent, bolted or welded, depending on the configuration of the unit.

Each part can be elevated and lowered, making it suitable for water and drain pipe.

The perimeter base frame is 100 mm high, C-shaped and bolted on all units.

The base frames for all of the above solutions are made of galvanized steel with a thickness of at least 2 mm.

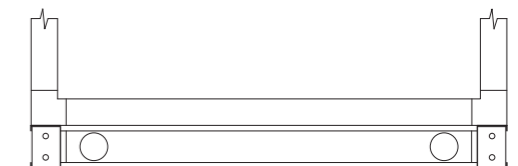

SECTION VIEW
The baseframe is flush with the panel.

Covering Roof (TT - Accessory)

- Units that are installed outdoors or that are frequently exposed to the weather can be fitted with a hot galvanized steel roof (with a galvanization of 140 g/m² or higher) as an accessory element.
- The roof overhang relative to the outer length of the unit is about 100 mm.
- All roof corners are equipped with protectors to prevent accidents.

Filtration

Plate Filters COARSE 55%

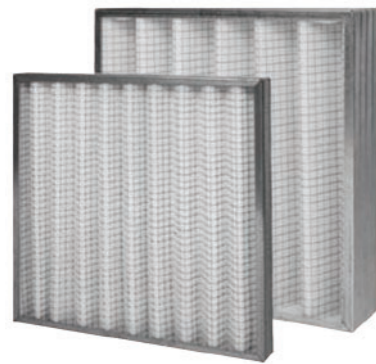

The plate filter filters air at low and medium efficiency.

- Plate filters are generally used as pre-filters to maintain the efficiency of the filters installed downstream for longer.
- Plate filters are installed on guides fixed inside the unit. In this case, the air by-pass will be minimal.

Plate filters are widely used due to the following features:

- Easy to remove
- Easy to obtain spare parts
- Highly regenerable, they can be cleaned with warm water and soap or common household detergent.

Features of Plate filters

- Galvanized steel sheet frame 48 mm thick
- Support containing net made of galvanized electrowelded wire
- Filtering material made of synthetic fiber with a filtration efficiency of COARSE 55%

Filtration

Bag Filters ePM1 50%



Bag filters are characterized by a large filtration area due to their bag-like shape, which greatly reduces the airflow velocity as the air passes through the filter.

The bags are installed on a galvanized slide and can be removed from the side. This filtering section includes an access door.

Features of soft bag filters

- Efficiency of ePM1 50%
- 287 mm deep
- Filter material made of fiberglass
- Galvanized steel sheet frame
- 80% of the material is recyclable
- Can be used even at 100% relative humidity.

N.B.: ePM1 50% bag filters are mandatory to comply with ECODSIGN ErP 2016.

Thermal Exchange Sections

DX Coil



Contents

- DX coil with copper tubes and aluminum fins, specifically designed to ensure a high thermal exchange rate and an excellent ratio of sensible and latent heat;
- One distributor and one electronic expansion valve for each circuit are connected to the control PCB, and the control PCB is located in close proximity to avoid interference, immunity, and electromagnetic interference problems;
- The temperature probes installed at the front, rear, and middle of the coil provide data to the control PCB, which in turn determines the opening of the electronic expansion valve according to the work point and the setpoint;

In multi-module units, the cooling circuits are interlaced to ensure full utilization of the exchange surface and the uniformity of the air being processed even under partial loads. The section includes the control PCB.

Thermal Exchange Sections

Electrical heating



Electrical heating section is used for heating and post-heating processing

The thermal exchange sections consist of:

- Galvanized steel sheet flanged containing frame
- Finned steel tubular heaters on base insulators
- Safety fix thermostat with manual reset
- Electric heating is assumed to have a capacity of up to 36 kW at 400 V/3-phase/50 Hz system.

Fan Section

EC Inverter Plug-Fan



The fan section is equipped with an EC Inverter Plug-Fan.

- EC Inverter Plug-Fans are electronically controlled to adjust the fan speed to provide airflow and static pressure according to the system capacity. By varying the airflow according to the required heat load, the system reduces energy consumption and noise, which is effective especially when partial loads are applied.
- The EC Inverter Plug-Fans allow the user to set various working conditions to meet the needs of the unit directly on site from the control panel on the Electrical Board section. If the wind is weaker than expected, for example, the operating conditions can be changed and adjusted with ease.
- Compared to traditional plug fans, the use of EC inverter technology has greatly improved the overall efficiency and acoustic properties of fans. The blade geometry with a diagonal trailing edge has positive effects on the aerodynamic performance and on the smoothness of fan rotation. The same holds true for the contour of the mounted nozzle.
- By integrating the EC motor directly into the impeller with the fan, the overall dimensions of the section can be minimized. There is no need for the commonly used belt drive between the motor and the fan. This reduces the amount of installation required and associated installation work.
- The EC inverter Plug Fans substantially exceed the requirements for energy efficiency class A+ requirements listed in the German Manufacturers Association RLT Directive 01 "General Requirements for Ventilation and Air Conditioning Equipment" and in the ErP2015 standards respectively.
- The EC inverter Plug Fans used in the fan section of the AHU provide constant airflow and constant available static pressure with an automatic control system. An electronic device with a pressure sensor mounted in the system and a control sensor on the EC inverter Plug Fans adjust the airflow rate and the available static pressure to keep the airflow constant.

Humidifier



Electrode humidifiers specifically designed for installation inside Air handling units

- The humidifier consists of two electrically connected parts: a hydraulic part and a control unit based on a microprocessor board. The hydraulic part is completely inserted into the AHU, and sits on top of the drain tank immediately downstream of the cooling coil.
- This control is fully integrated into the microprocessor in the AHU.
- The hydraulic boiler consists of a plastic polypropylene channel with a cross section of 33 cm × 16 cm high and a length proportional to the width of the AHU. Stainless steel electrodes are placed vertically inside the boiler, connected to the power supply, and are easily removable. The plastic lid is inclined so that any condensation will drain into the boiler in order to avoid power losses.
- Narrow longitudinal slots between the plastic sections allow air to fill the entire length of the AHU section by outputting the generated steam.
- This prevents condensate from being generated in the pipes and also prevents the steam pressure in the boiler from rising due to clogging of the steam pipes.

On one side of the kettle, there is a body for hydraulic management of the system, which can be easily accessed after installation.

- Maximum water level sensor
- The drainage block is specially designed to empty the tank of water and limestone debris without blocking the tank or interrupting the flow of water, allowing the work to be done without applying pressure.

An electronic rotation sensor grafted to the pivot motor communicates with the microprocessor to manage correct operation, and any malfunctions are indicated on the display.

Heat Recovery Section

Cross-flow heat recovery



The efficiency of the recovery unit is up to 85%.

- The fixed plate static recovery units are air-to-air with no moving parts, making the system reliable and safe. The air moves in a cross flow, where heat is transferred directly from the hotter stream to the cooler stream. The efficiency of the recovery unit is up to 85%.
- This type of heat exchanger is made of pressed aluminum sheets and is housed at various intervals depending on the type of use.
- The edges are sealed to prevent renewed air from being contaminated from polluting agents contained in exhaust air.

Normal supply is assumed to be as follows:

- Recovery units with aluminum fins
- Cell prefilters COARSE 55% (85% efficiency) installed on the fresh air side
- Galvanized steel sheet drain pan to collect possible condensation

Heat Recovery Section

Heat Wheel Recovery Units



The principle of operation is as follows:

- The exhaust air travels across the semi-circular rotor sector, transferring some of its heat to the metal mass. As the exhaust passes through the half circular rotor sector, it transfers heat to the metal parts, which in turn transfers the heat to the fresh, cool air drawn in from outside through the other side of the half circular rotor sector, thus allowing ventilation without cooling the room. When the rotor is of the hygroscopic type, the humidity contained in the exhaust air will also be partially transferred to the regenerative air.
- The terms "warm air" and "cold air" as used above are valid for the winter operating cycle; in the summer operating cycle, the functions of heat and humidity transfer and absorption are reversed.

Typically, these types of recovery units consist of:

- Aluminum rotor
- Galvanized steel sheet frame
- Constant speed electric gearmotor

Dimensions

Configurations A

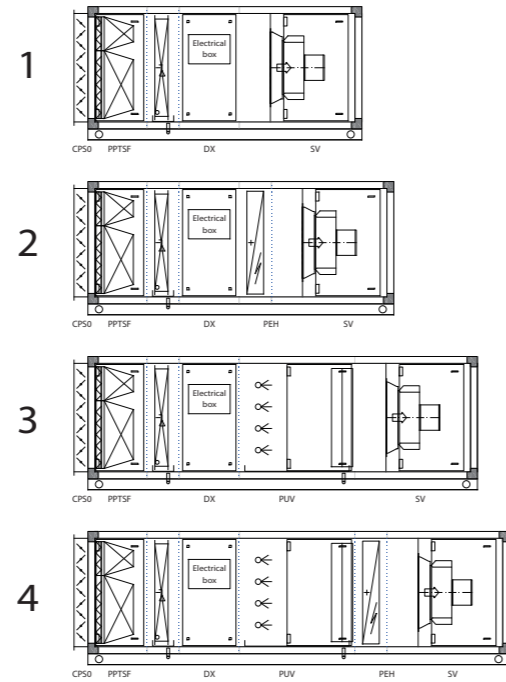

Model name	Config.	H (mm)	W (mm)	L (mm)	kg	L (with silencer) (mm)
AHYA025GWAA	1	1,064	1,154	2,619	611	3,529
AHYA025GWAB	2	1,064	1,154	3,109	679	4,019
AHYA025GWAC	3	1,064	1,154	2,619	629	3,529
AHYA025GWAD	4	1,064	1,154	3,109	697	4,019
AHYA040GWAA	1	1,199	1,354	2,749	844	3,659
AHYA040GWAB	2	1,199	1,354	3,319	931	4,229
AHYA040GWAC	3	1,199	1,354	2,749	865	3,659
AHYA040GWAD	4	1,199	1,354	3,319	952	4,229
AHYA048GWAA	1	1,309	1,574	2,749	921	3,659
AHYA048GWAB	2	1,309	1,574	3,319	1,023	4,229
AHYA048GWAC	3	1,309	1,574	2,749	944	3,659
AHYA048GWAD	4	1,309	1,574	3,319	1,046	4,229
AHYA080GWAA	1	1,544	2,074	3,189	1,542	4,099
AHYA080GWAB	2	1,544	2,074	3,839	1,701	4,749
AHYA080GWAC	3	1,544	2,074	3,189	1,570	4,099
AHYA080GWAD	4	1,544	2,074	3,839	1,729	4,749
AHYA096GWAA	1	1,789	2,250	3,189	1,691	4,099
AHYA096GWAB	2	1,789	2,250	3,839	1,869	4,749
AHYA096GWAC	3	1,789	2,250	3,189	1,724	4,099
AHYA096GWAD	4	1,789	2,250	3,839	1,899	4,749

Configurations B

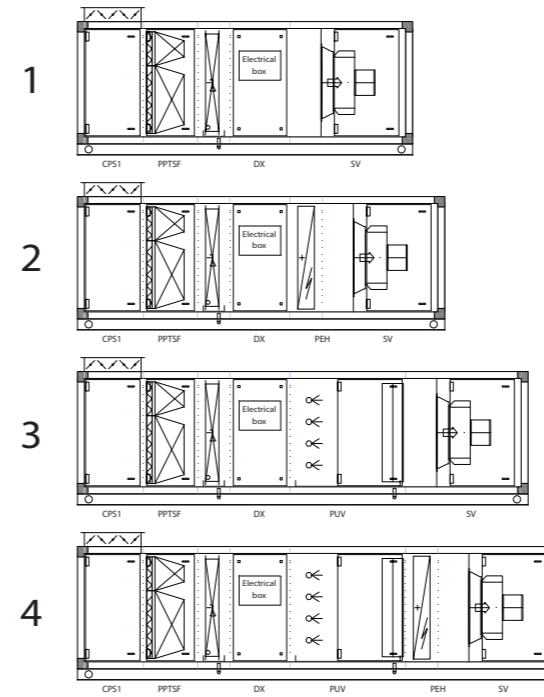

Model name	Config.	H (mm)	W (mm)	L (mm)	kg	L (with silencer) (mm)
AHYB025GWAA	1	1,179	1,154	2,854	628	3,764
AHYB025GWAB	2	1,179	1,154	3,344	696	4,254
AHYB025GWAC	3	1,179	1,154	2,854	646	3,764
AHYB025GWAD	4	1,179	1,154	3,344	714	4,254
AHYB040GWAA	1	1,314	1,354	3,084	873	3,994
AHYB040GWAB	2	1,314	1,354	3,654	960	4,564
AHYB040GWAC	3	1,314	1,354	3,084	894	3,994
AHYB040GWAD	4	1,314	1,354	3,654	981	4,564
AHYB048GWAA	1	1,424	1,574	3,084	953	3,994
AHYB048GWAB	2	1,424	1,574	3,654	1,055	4,564
AHYB048GWAC	3	1,424	1,574	3,084	976	3,994
AHYB048GWAD	4	1,424	1,574	3,654	1,078	4,564
AHYB080GWAA	1	1,659	2,074	3,624	1,591	4,534
AHYB080GWAB	2	1,659	2,074	4,274	1,749	5,184
AHYB080GWAC	3	1,659	2,074	3,624	1,619	4,534
AHYB080GWAD	4	1,659	2,074	4,274	1,777	5,184
AHYB096GWAA	1	1,904	2,250	3,724	1,760	4,634
AHYB096GWAB	2	1,904	2,250	4,374	1,936	5,284
AHYB096GWAC	3	1,904	2,250	3,724	1,790	4,634
AHYB096GWAD	4	1,904	2,250	4,374	1,966	5,284

Configurations C

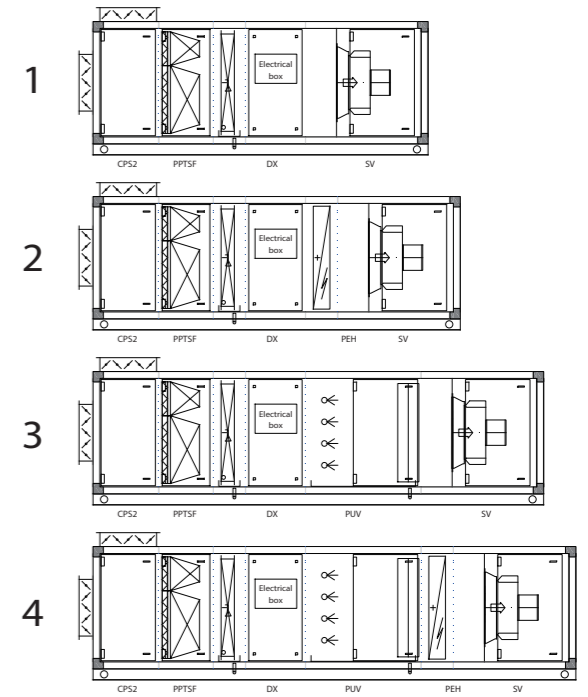

Model name	Config.	H (mm)	W (mm)	L (mm)	kg	L (with silencer) (mm)
AHYC025GWAA	1	1,179	1,154	2,969	650	3,879
AHYC025GWAB	2	1,179	1,154	3,459	718	4,369
AHYC025GWAC	3	1,179	1,154	2,969	668	3,879
AHYC025GWAD	4	1,179	1,154	3,459	736	4,369
AHYC040GWAA	1	1,314	1,354	3,199	899	4,109
AHYC040GWAB	2	1,314	1,354	3,769	986	4,679
AHYC040GWAC	3	1,314	1,354	3,199	920	4,109
AHYC040GWAD	4	1,314	1,354	3,769	1,007	4,679
AHYC048GWAA	1	1,424	1,574	3,199	980	4,109
AHYC048GWAB	2	1,424	1,574	3,769	1,082	4,679
AHYC048GWAC	3	1,424	1,574	3,199	1,003	4,109
AHYC048GWAD	4	1,424	1,574	3,769	1,105	4,679
AHYC080GWAA	1	1,659	2,074	3,739	1,624	4,649
AHYC080GWAB	2	1,659	2,074	4,389	1,782	5,299
AHYC080GWAC	3	1,659	2,074	3,739	1,652	4,649
AHYC080GWAD	4	1,659	2,074	4,389	1,810	5,299
AHYC096GWAA	1	1,904	2,250	3,839	1,799	4,749
AHYC096GWAB	2	1,904	2,250	4,489	1,975	5,399
AHYC096GWAC	3	1,904	2,250	3,839	1,829	4,749
AHYC096GWAD	4	1,904	2,250	4,489	2,005	5,399

Configurations D

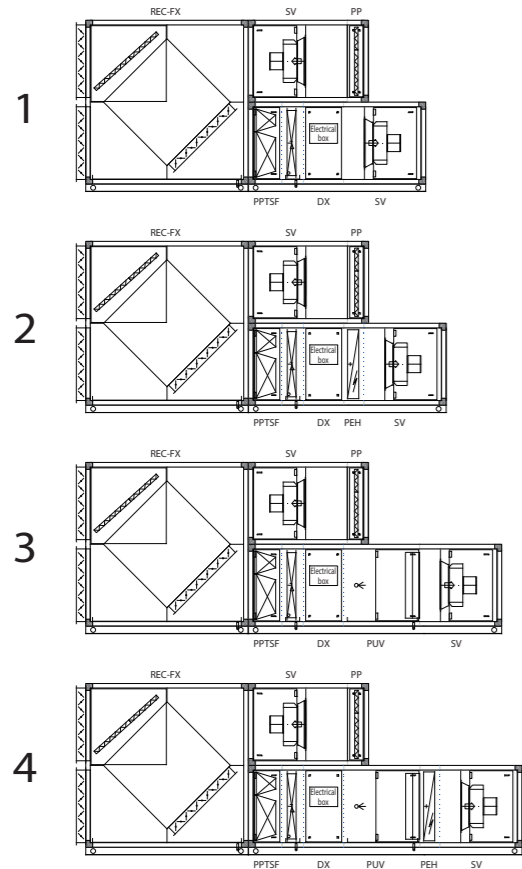

Model name	Config.	H (mm)	W (mm)	L (mm)	kg	L (with silencer) (mm)
AHYD025GWAA	1	2028/1064	1424/1154	4,311	1,259	5,221
AHYD025GWAB	2	2028/1064	1424/1154	4,801	1,327	5,711
AHYD025GWAC	3	2028/1064	1424/1154	4,311	1,277	5,221
AHYD025GWAD	4	2028/1064	1424/1154	4,801	1,345	5,711
AHYD040GWAA	1	2298/1199	1574/1354	4,871	1,750	5,781
AHYD040GWAB	2	2298/1199	1574/1354	5,441	1,837	6,351
AHYD040GWAC	3	2298/1199	1574/1354	4,871	1,771	5,781
AHYD040GWAD	4	2298/1199	1574/1354	5,441	1,858	6,351
AHYD048GWAA	1	2518/1309	1824/1574	4,871	1,978	5,781
AHYD048GWAB	2	2518/1309	1824/1574	5,348	2,080	6,258
AHYD048GWAC	3	2518/1309	1824/1574	4,778	2,001	5,688
AHYD048GWAD	4	2518/1309	1824/1574	5,348	2,103	6,258
AHYD080GWAA	1	2988/1544	2,074	6,161	3,361	7,071
AHYD080GWAB	2	2988/1544	2,074	6,811	3,520	7,721
AHYD080GWAC	3	2988/1544	2,074	6,161	3,389	7,071
AHYD080GWAD	4	2988/1544	2,074	6,811	3,548	7,721
AHYD096GWAA	1	3478/1789	2,250	6,451	3,849	7,361
AHYD096GWAB	2	3478/1789	2,250	7,008	4,025	7,918
AHYD096GWAC	3	3478/1789	2,250	6,451	3,879	7,268
AHYD096GWAD	4	3478/1789	2,250	7,008	4,055	7,918

Configurations E

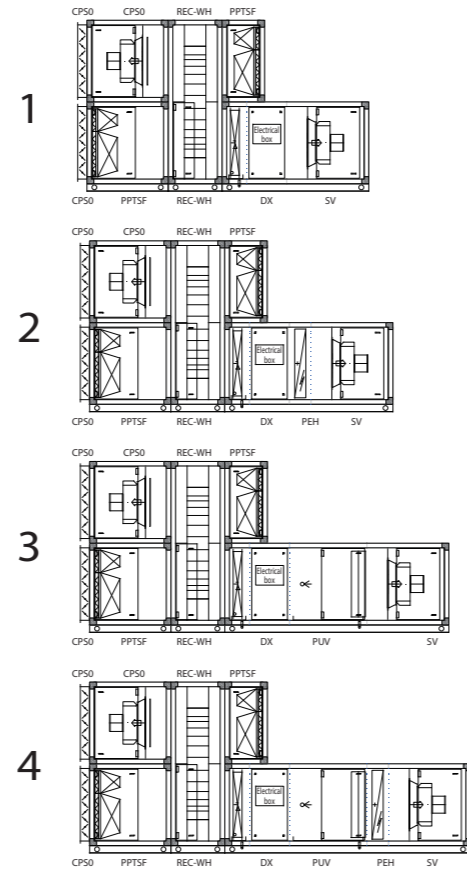

Model name	Config.	H (mm)	W (mm)	L (mm)	kg	L (with silencer) (mm)
AHYE025GWAA	1	2028/1064	1429/1154	3,813	1,150	4,723
AHYE025GWAB	2	2028/1064	1429/1154	4,303	1,226	5,213
AHYE025GWAC	3	2028/1064	1429/1154	3,813	1,168	4,723
AHYE025GWAD	4	2028/1064	1429/1154	4,303	1,244	5,213
AHYE040GWAA	1	2298/1199	1729/1354	4,073	1,571	4,983
AHYE040GWAB	2	2298/1199	1729/1354	4,643	1,658	5,553
AHYE040GWAC	3	2298/1199	1729/1354	4,073	1,592	4,983
AHYE040GWAD	4	2298/1199	1729/1354	4,643	1,679	5,553
AHYE048GWAA	1	2518/1309	1829/1574	4,073	1,696	4,983
AHYE048GWAB	2	2518/1309	1829/1574	4,643	1,798	5,553
AHYE048GWAC	3	2518/1309	1829/1574	4,073	1,719	4,983
AHYE048GWAD	4	2518/1309	1829/1574	4,643	1,821	5,553
AHYE080GWAA	1	2988/1544	2374/2074	4,953	2,753	5,863
AHYE080GWAB	2	2988/1544	2374/2074	5,603	2,912	6,513
AHYE080GWAC	3	2988/1544	2374/2074	4,953	2,781	5,863
AHYE080GWAD	4	2988/1544	2374/2074	5,603	2,940	6,513
AHYE096GWAA	1	3478/1789	2582/2250	4,953	3,035	5,863
AHYE096GWAB	2	3478/1789	2582/2250	5,603	3,211	6,513
AHYE096GWAC	3	3478/1789	2582/2250	4,953	3,065	5,863
AHYE096GWAD	4	3478/1789	2582/2250	5,603	3,241	6,513

Silencer PI

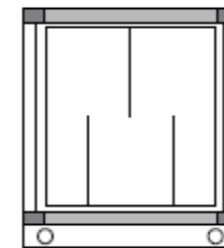

Connectable AHU model name	H (mm)	L (mm)	W (mm)	Kg
AHY* 025GWA*	1064	910	1154	209
AHY* 040GWA*	1199	910	1354	233
AHY* 048GWA*	1309	910	1574	274
AHY* 080GWA*	1544	910	2074	280
AHY* 096GWA*	1789	910	2250	444

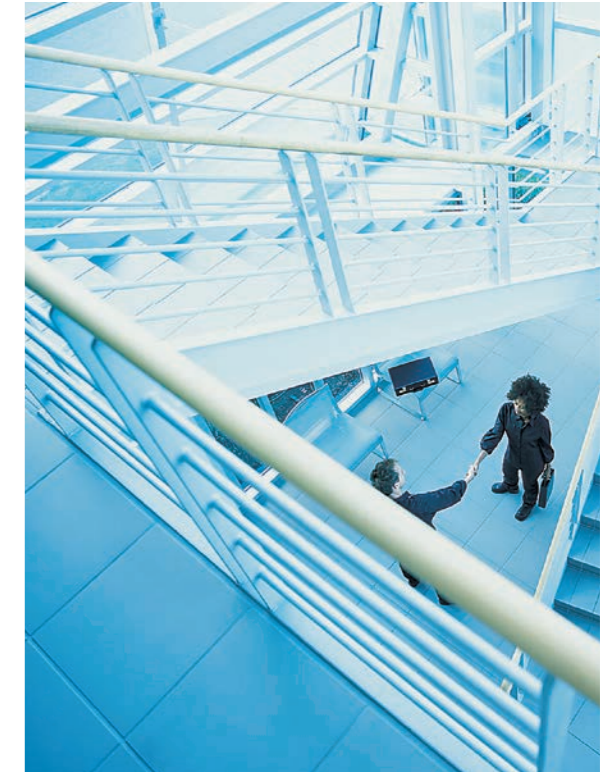

Loose Accessories

Galvanized metal sheet roof

Units that are installed outdoors or that are frequently exposed to the weather can be fitted with a hot galvanized steel roof (with a galvanization of 140 g/m² or higher) as an accessory element.

The roof overhang relative to the outer length of the unit is about 100 mm. All roof corners are equipped with protectors to prevent accidents.

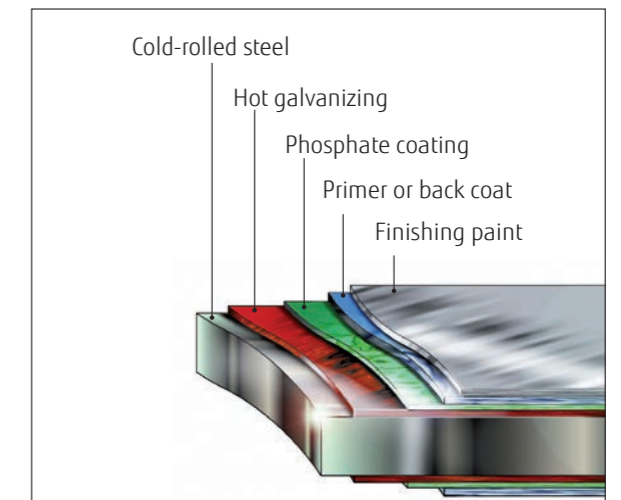

Total Pressure Drop Calculation

Air handling units (AHUs) controlled by EC inverter Plug Fans meet a high range of required airflows and static pressures.

The EC Inverter Plug-Fans allow the user to set various working conditions to meet the needs of the unit directly on site from the control panel on the Electrical Board section. If the wind is weaker than expected, for example, the operating conditions can be changed and adjusted with ease.

Selection procedure

- Select the most suitable AHU model according to the airflow rate.
- Based on the required airflow and overall static pressure value, identify the operating point of the airflow static pressure on the curve for the selected fan.

To calculate the overall static pressure value, refer to the component pressure drop table and add the net static pressure required for the plant.



Fan characteristic curves

Fan type 400 mm

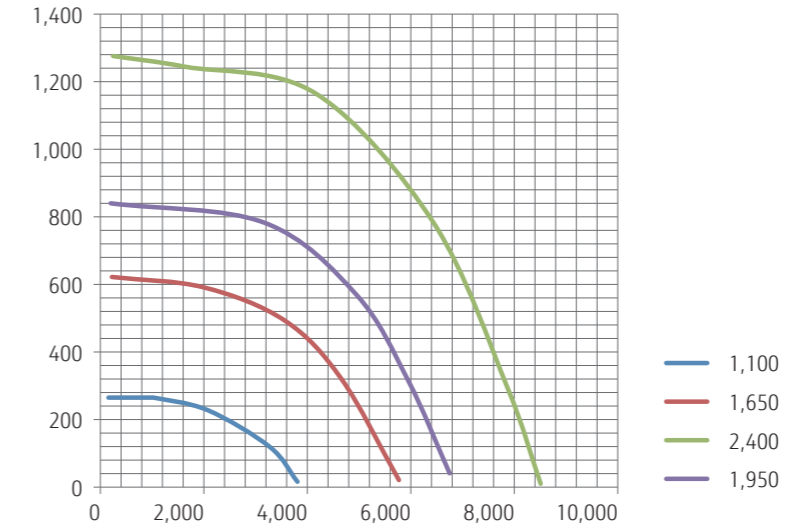

Component pressure drop table

ODU	AHU SIZE	MIN. NOM. MAX.	Airflow	Inlet damper (Config. A-E)	Inlet damper (Config. B-C)	COARSE 55% filters - supply	ePM1 50% filters	DX coil	Silencer	PHE + dampers + COARSE 55% filters - supply	PHE + damper - exhaust	COARSE 55% filters - exhaust (Config. D)	Heat wheel - supply	COARSE 55% filters - supply (Config. E)	ePM1 50% filters (Config. E)	Heat wheel - exhaust	COARSE 55% filters - exhaust (Config. E)	Exhaust damper (Config. E)	Humidifier	Electrical heater
			m³/h	Pa	Pa	Pa	Pa	Pa	Pa	Pa	Pa	Pa	Pa	Pa	Pa	Pa	Pa	Pa	Pa	Pa
10HP	025	MIN.	4,300	1	12	91	156	55	26	206	120	91	162	93	144	159	84	7	-	-
		NOM.	4,500	1	13	98	158	59	28	210	122	95	167	93	146	165	95	8	-	-
		MAX.	5,000	2	16	99	164	71	36	235	147	96	187	95	150	185	96	10	-	-
14 HP	040	MIN.	5,000	1	4	91	138	37	4	154	70	91	116	89	135	114	91	4	-	-
		NOM.	7,200	2	13	87	149	68	10	240	145	87	172	93	144	169	94	8	-	-
		MAX.	8,000	2	16	96	153	82	12	243	165	96	193	94	147	190	96	9	-	-
18 HP	048	MIN.	8,100	1	12	96	153	50	10	225	139	92	167	94	147	165	92	9	-	-
		NOM.	8,600	1	13	97	156	55	11	241	155	93	178	95	149	176	93	10	-	-
		MAX.	9,100	2	15	98	159	60	13	257	171	93	189	95	152	187	93	11	-	-
2X 14 HP	080	MIN.	11,000	1	8	91	140	30	9	148	62	90	121	90	137	119	90	6	-	-
		NOM.	14,500	2	14	94	148	47	16	188	101	93	163	93	143	161	93	10	-	-
		MAX.	16,100	2	17	96	153	56	19	209	122	94	183	94	147	180	94	13	-	-
2X 18 HP	096	MIN.	16,000	1	10	96	152	37	16	157	74	91	146	92	142	144	91	10	-	-
		NOM.	17,300	1	11	97	156	42	19	168	86	92	159	93	145	157	92	11	-	-
		MAX.	18,100	1	13	98	158	46	21	175	93	92	167	93	146	165	92	13	-	-

fan type	m³/h	Pa Total static pressure	W	n	LwAin	LwAout
				[1/min]	[dB]	[dB]
400 mm	156	265	124	1100	63	71
400 mm	334	265	134	1100	63	70
400 mm	1002	265	187	1100	62	69
400 mm	1025	265	181	1100	62	69
400 mm	2072	228	234	1100	58	66
400 mm	3275	119	224	1100	62	69
400 mm	3809	16	173	1100	69	74
400 mm	223	622	352	1650	75	82
400 mm	2005	591	642	1650	72	79
400 mm	3564	493	767	1650	68	75
400 mm	4656	321	708	1650	71	77
400 mm	5770	21	487	1650	79	83
400 mm	200	840	509	1950	79	86
400 mm	3163	783	1154	1950	74	81
400 mm	4946	570	1223	1950	74	80
400 mm	5948	316	1027	1950	78	83
400 mm	6750	41	773	1950	83	87
400 mm	245	1276	921	2400	85	92
400 mm	1649	1244	1497	2400	86	92
400 mm	4163	1165	2223	2400	81	87
400 mm	6438	783	2237	2400	81	87
400 mm	7864	296	1738	2400	86	91
400 mm	8510	10	1389	2392	89	93

Fan type 560 mm

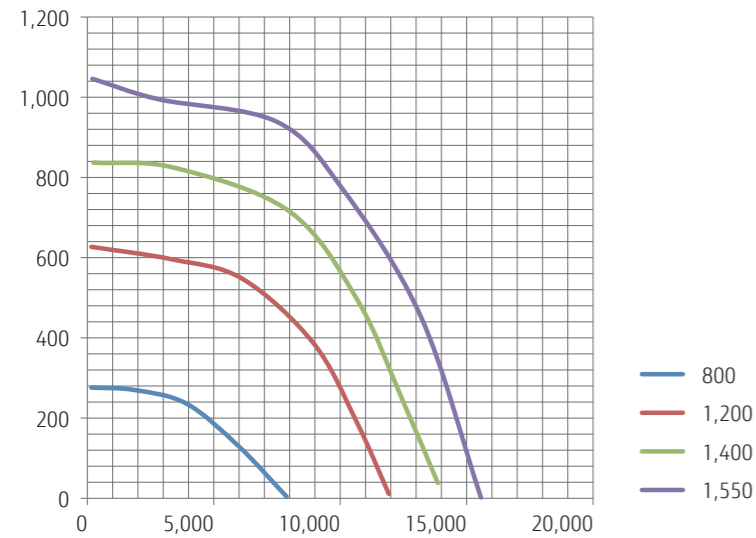

fan type	m³/h	Pa Total static pressure	W	n	LwAin	LwAout
				[1/min]	[dB]	[dB]
560 mm	158	276	209	800	65	72
560 mm	1861	270	345	800	65	71
560 mm	3921	236	438	800	61	67
560 mm	5980	130	452	800	62	67
560 mm	7881	4	313	800	69	74
560 mm	158	627	591	1200	77	83
560 mm	3327	596	1164	1200	75	82
560 mm	6139	547	1471	1200	71	77
560 mm	8950	386	1473	1200	72	78
560 mm	10653	190	1212	1200	76	82
560 mm	11921	11	936	1200	80	85
560 mm	238	837	901	1400	80	87
560 mm	3446	824	1743	1400	80	87
560 mm	8000	715	2403	1400	75	81
560 mm	10693	493	2260	1400	76	82
560 mm	12475	243	1859	1400	80	86
560 mm	13861	38	1521	1400	85	89
560 mm	198	1046	1210	1550	84	90
560 mm	2812	995	2086	1550	84	91
560 mm	7485	939	3131	1550	78	84
560 mm	10059	774	3249	1550	77	84
560 mm	13188	453	2901	1550	82	88
560 mm	15564	2	1948	1550	91	94

Fan type 710 mm

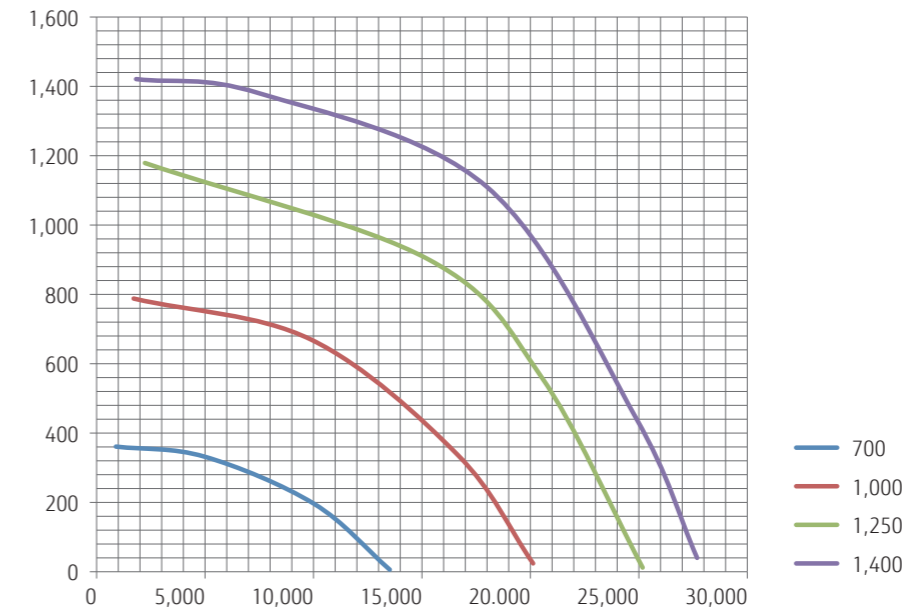

fan type	m³/h	Pa Total static pressure	W	n	LwAin	LwAout
				[1/min]	[dB]	[dB]
710 mm	891	361	744	700	71	77
710 mm	4975	332	1290	700	69	74
710 mm	10025	196	1427	700	69	75
710 mm	13515	6	880	700	77	83
710 mm	1708	788	1693	1000	81	88
710 mm	9876	670	3179	1000	77	83
710 mm	16634	338	3084	1000	80	86
710 mm	20124	24	2177	1000	87	93
710 mm	2228	1179	3015	1250	87	94
710 mm	15297	901	6054	1250	83	89
710 mm	20495	563	5794	1250	86	92
710 mm	25173	12	3857	1250	92	98
710 mm	1821	1421	3716	1400	89	96
710 mm	7500	1380	5851	1400	89	95
710 mm	17996	1110	8301	1400	86	92
710 mm	24855	445	6916	1400	91	98
710 mm	27685	40	5271	1400	95	101

Specifications

Configuration A-B-C

Model FG	025	040	048	080	096	
Model name	AHYA025GWA* AHYB025GWA* AHYC025GWA*	AHYA040GWA* AHYB040GWA* AHYC040GWA*	AHYA048GWA* AHYB048GWA* AHYC048GWA*	AHYA080GWA* AHYB080GWA* AHYC080GWA*	AHYA096GWA* AHYB096GWA* AHYC096GWA*	
Casing						
Material	Outer skin: 0.6 mm thick pre-painted galvanized sheet; Inner skin: 0.6 mm thick galvanized sheet					
Insulation	Polyurethane foam, 50 mm thick, 45 kg/m ³					
Performance						
Cooling capacity	kW	25	40	48	78	96
Heating capacity	kW	31.5	45	50	81.5	100
Available static pressure	Pa	200	200	200	200	200
Power supply	V/Ph/Hz	400/3/50	400/3/50	400/3/50	400/3/50	400/3/50
Airflow						
Max.	m ³ /h	5000	8000	9100	16100	18100
Rated	m ³ /h	4500	7200	8600	14500	17300
Min.	m ³ /h	4300	5000	8100	11000	16000
Cross-flow heat recovery						
Efficiency (*)	356	—	—	—	—	—
DX Coil						
Rows	n°	4				
Coil type	25 × 22 - 3/8"					
Coil duty	Cooling/Heating					
Fluid	R410A					
Pipe material	Copper					
Fin material	Aluminum					
Electrical heating						
Stages	n°	3				
Heating capacity	kW	9	15	18	30	36
Humidifier						
Fix steam capacity	kg/h	15	25	30	45	60
Fan						
Type	EC inverter Plug Fan					
Motor data	mm	400	560	560	710	710
	kW	2.4	3.4	3.4	7.3	7.3
Thermal transmittance of casing (TT) class	T3	T3	T3	T3	T3	
Thermal bridging factor (TBF) class	TB3	TB3	TB3	TB3	TB3	
Casing strength (CS) class	D2 (M)	D2 (M)	D2 (M)	D2 (M)	D2 (M)	
Casing air leakage (CAL) class@-400Pa	L2 (M)	L2 (M)	L2 (M)	L2 (M)	L2 (M)	
Casing air leakage (CAL) class@ +700 Pa	> L3 (M)	> L3 (M)	> L3 (M)	> L3 (M)	> L3 (M)	
Filter bypass leakage (FBL) class	F9 (M)	F9 (M)	F9 (M)	F9 (M)	F9 (M)	

(*) at rated airflow

Configuration D

Model FG	025	040	048	080	096	
Model name	AHYD025GWA*	AHYD040GWA*	AHYD048GWA*	AHYD080GWA*	AHYD096GWA*	
Casing						
Material	Outer skin: 0.6 mm thick pre-painted galvanized sheet; Inner skin: 0.6 mm thick galvanized sheet					
Insulation	Polyurethane foam, 50 mm thick, 45 kg/m ³					
Performance						
Cooling capacity	kW	25	40	48	78	96
Heating capacity	kW	31.5	45	50	81.5	100
Available static pressure	Pa	200	200	200	200	200
Power supply	V/Ph/Hz	400/3/50	400/3/50	400/3/50	400/3/50	400/3/50
Airflow						
Max.	m ³ /h	5000	8000	9100	16100	18100
Rated	m ³ /h	4500	7200	8600	14500	17300
Min.	m ³ /h	4300	5000	8100	11000	16000
Heat recovery						
Efficiency (*)	356	73.3	74.4	74.2	73.7	73.6
DX Coil						
Rows	n°	4				
Coil type	25 × 22 - 3/8"					
Coil duty	Cooling/Heating					
Fluid	R410A					
Pipe material	Copper					
Fin material	Aluminum					
Electrical heating						
Stages	n°	3				
Heating capacity	kW	9	15	18	30	36
Humidifier						
		15	25	30	45	60
Fan						
Type	EC inverter Plug Fan					
Motor data	mm					
	kW	2.4	3.4	3.4	7.3	7.3
Thermal transmittance of casing (TT) class	T3	T3	T3	T3	T3	
Thermal bridging factor (TBF) class	TB3	TB3	TB3	TB3	TB3	
Casing strength (CS) class	D2 (M)	D2 (M)	D2 (M)	D2 (M)	D2 (M)	
Casing air leakage (CAL) class@-400Pa	L2 (M)	L2 (M)	L2 (M)	L2 (M)	L2 (M)	
Casing air leakage (CAL) class@ +700 Pa	> L3 (M)	> L3 (M)	> L3 (M)	> L3 (M)	> L3 (M)	
Filter bypass leakage (FBL) class	F9 (M)	F9 (M)	F9 (M)	F9 (M)	F9 (M)	

Configuration E

025	040	048	080	096
AHYE025GWA*	AHYE040GWA*	AHYE048GWA*	AHYE080GWA*	AHYE096GWA*
Casing				
Outer skin: 0.6 mm thick pre-painted galvanized sheet; Inner skin: 0.6 mm thick galvanized sheet				
Polyurethane foam, 50 mm thick, 45 kg/m ³				
Performance				
25	40	48	78	96
31.5	45	50	81.5	100
200	200	200	200	200
400/3/50	400/3/50	400/3/50	400/3/50	400/3/50
Airflow				
5000	8000	9100	16100	18100
4500	7200	8600	14500	17300
4300	5000	8100	11000	16000
Cross-flow heat recovery				
75.6	74.7	74.2	75.3	75.6
DX Coil				
4				
25 × 22 - 3/8"				
Cooling/Heating				
R410A				
Copper				
Aluminum				
Electrical heating				
3				
9	15	18	30	36
Humidifier				
15	25	30	45	60
Fan				
EC inverter Plug Fan				
2.4	3.4	3.4	7.3	7.3
T3	T3	T3	T3	T3
TB3	TB3	TB3	TB3	TB3
D2 (M)	D2 (M)	D2 (M)	D2 (M)	D2 (M)
L2 (M)	L2 (M)	L2 (M)	L2 (M)	L2 (M)
> L3 (M)	> L3 (M)	> L3 (M)	> L3 (M)	> L3 (M)
F9 (M)	F9 (M)	F9 (M)	F9 (M)	F9 (M)

(*) at rated airflow

Control system

AHU units include a built-in electrical panel and expansion valve with control PCB. Setpoint is fixed via standard wired control. The cooling load is determined by the air return temperature and the setpoint of the wired control.

AHU Controller

UTY-TXUX



Features

- Easy to install. Control connects to AHU PLC.
- Controls can be installed after the building is decorated.
- Mode lock function: Allows users to lock the operating mode of the AHU.

Easy operation

This remote controller provides an intuitive user interface with a touch screen display.

Functions

- Schedule setting change
- Set temperature and humidity
- Ambient name
- Alarm setting
- Event setting

Specifications

Model name		UTY-TXUX
Format	mm	120 × 86 × 25
Screen resolution		Display touch color 3.5" 320 × 240
Power supply		24 V AC - 24 V AC/DC
Analogue inputs		1 × Integrated NTC
Connectivity		RS485 - MODBUS® SL, USB Micro-B (debug and programming)
Operating temperature		0 - +50 °C

System controller

UTY-APGXZ1 Software

Features

System controller enables advanced integrated monitoring and control of VRF network systems operating in small to large buildings.

- System controller controls up to 4 VRF network systems, 1,600 indoor units, and 400 outdoor units.
- To accommodate facility management needs, the system controller offers—in addition to precise air conditioning control—remote central control, electricity charge apportionment, schedule management, and energy-saving options for VRF network systems.

Max. Controllable
4 VRF network systems

Max. Controllable
400 outdoor units

Max. Controllable
1,600 indoor units



System controller Lite

UTY-ALGXZ1 + UTY-PLGXX2 Software

Features

System controller Lite offers a set of standard functions to manage air conditioners operating in a small or midsize building.

- System controller Lite controls up to 1 VRF network system, 400 indoor units, and 100 outdoor units.
- In addition to precise air conditioning control, a variety of management-specific applications are available as options, enabling a wider range of control.

Max. Controllable
1 VRF network systems

Max. Controllable
100 outdoor units

Max. Controllable
400 indoor units



Centralized control is also possible to stop the operation of not only air conditioners, but also lighting and ventilation equipment. These features are useful for managing the energy efficiency of the entire building.



Summary of functions

Function	Type	System controller		System controller Lite				
		UTY-APGXZ1	Option UTY-PEGXZ1	UTY-ALGXZ1	Option UTY-PLGXR2	Option UTY-PLGXA2	Option UTY-PLGXE2	Option UTY-PLGXX2
System specification	Max. number of VRF networks supported	4	-	1	-	-	-	-
	Max. number of indoor unit and remote controller groups per VRF network	400	-	400	-	-	-	-
	Max. number of outdoor units per VRF network	100	-	100	-	-	-	-
	Max. number of indoor units and remote controller groups per system controller	1600	-	400	-	-	-	-
	Max. number of outdoor units per system controller	400	-	100	-	-	-	-
Site supervision	Multiple site display	10	-	10	-	-	-	-
	Number of buildings per site	20	-	-	-	-	-	-
	Number of floors per site	200	-	-	-	-	-	-
	Number of floors per building	50	-	-	-	-	-	-
	3D graphical layout view	●	-	-	-	-	-	-
	2D graphical layout view	●	-	-	-	-	-	-
	List display	●	-	●	-	-	-	-
Error management	Tree display	●	-	●	-	-	-	-
	Group display	●	-	●	-	-	-	-
	Error notification	●	-	●	-	-	-	-
History	Audible alarm	●	-	●	-	-	-	-
	E-mail notification of errors	●	-	●	-	-	-	-
Operation control	Individual control	Error history	●	-	●	-	-	-
		Operation history	●	-	●	-	-	-
		Control history	●	-	●	-	-	-
		On/Off	●	-	●	-	-	-
		Operation mode*	●	-	●	-	-	-
		Room temperature	●	-	●	-	-	-
		Fan speed	●	-	●	-	-	-
	Individual management	Airflow direction	●	-	●	-	-	-
		Economy mode	●	-	●	-	-	-
		Setting temperature range limitation	●	-	●	-	-	-
Other	Anti-freeze	●	-	●	-	-	-	
	Low noise setting of outdoor units	●	-	●	-	-	-	
	Setting remote control prohibition	●	-	●	-	-	-	
Schedule	Setting temperature range limitation	Setting remote control prohibition	●	-	●	-	-	-
		Filter sign reset	●	-	●	-	-	-
	Memory operations	Filter sign reset	●	-	●	-	-	-
		Pattern operations	●	-	●	-	-	-
	Schedule	Annual Schedule	●	-	●	-	-	-
		Setting for a specific date	●	-	●	-	-	-
		On/Off per day	72	-	72	-	-	-
		On/Off per week	504	-	504	-	-	-
		Day off	●	-	●	-	-	-
		Minimum unit of timer setting (minutes)	10	-	10	-	-	-
Remote management	Weekly schedule for low noise mode	●	-	●	-	-	-	
	Web operation	●	-	●	-	-	-	
	Remote monitoring	●	-	-	●	-	-	
	Remote operation control	●	-	●	-	-	-	
Electricity charge apportionment	Remote function setting	●	-	-	●	-	-	
	Apportionment charge/bill calculation	●	-	-	●	-	-	
	Tenant (block) setting	●	-	-	●	-	-	
	Common facilities apportionment setting	●	-	-	●	-	-	
	Rated power consumption allotment setting	●	-	-	●	-	-	
Energy saving management	Individual calculations for cooling and heating	-	●	-	●	-	-	
	Electricity meter supported	-	●	-	●	-	-	
	Indoor unit rotation	-	●	-	-	●	-	
	Peak cut control	-	●	-	-	●	-	
	Capacity saving for outdoor unit	-	●	-	-	●	-	
	Record of energy saving operation	-	●	-	-	●	-	
Control of external devices	Information on energy saving	-	●	-	-	●	-	
	Power consumption monitor	-	●	-	-	●	-	
	Electricity meter supported	-	●	-	-	●	-	
Others	Monitor	●	-	-	-	-	●	
	Control	●	-	-	-	-	●	
	Importing and exporting databases	●	-	●	-	-	-	
	Automatic clock adjustment	●	-	●	-	-	-	
Others	Multiple language support	7 languages	-	7 languages	-	-	-	
	Refrigerant leak detection function	●	-	●	-	-	-	
	Power shutdown	●	-	●	-	-	-	

●: Available. -: Not available.

Computer requirements

The specifications required for the Computer are shown in the table below:

	System controller	System controller Lite
Operating system	<ul style="list-style-type: none"> Microsoft® Windows® 7 Home Premium (32-bit or 64-bit) SP1, Windows® 7 Professional (32-bit or 64-bit) SP1 Microsoft® Windows® 8.1 (32-bit or 64-bit), Windows® 8.1 Pro (32-bit or 64-bit) Microsoft® Windows® 10 Home (32-bit or 64-bit), Windows® 10 Pro (32-bit or 64-bit) Supported languages: English, Chinese, French, German, Russian, Spanish, and Polish	
CPU	Intel® Core™ i3 2 GHz or higher	
Memory	<ul style="list-style-type: none"> 2 GB or more (for Windows® 7 [32-bit]) 4 GB or more (for Windows® 7 [64-bit], Windows® 8.1, and Windows® 10) 	
HDD	40 GB or more of free space	
Screen resolution	1024 × 768 or higher	
Interface	<ul style="list-style-type: none"> Ethernet port (for getting access to the internet using LAN) or a modem (for getting access to the internet using a landline) Up to 6 USB ports (Only required for a server Computer working as a VRF controller) -Maximum of 2 USB ports are required to connect to a White-USB-key/WibuKey -Up to 4 USB ports required to connect to a Echelon® U10 USB network interface * Maximum number of required USB ports depends on the applicable system configuration. 	<ul style="list-style-type: none"> Ethernet port (for getting access to the internet using LAN) or a modem (for getting access to the internet using a landline) Up to 6 USB ports (Only required for a server Computer working as a VRF controller) -Maximum of 4 USB ports are required to connect to a White-USB-key/WibuKey -1 USB port is required for an Echelon® U10 USB Network Interface * The maximum number of required USB ports depends on the applicable system configuration.
Graphic accelerator	Microsoft® DirectX® 9.0c compatible	
Software	Adobe® Acrobat Reader® 9.0 or later	

* Echelon® U10 USB Network Interface - TP/FT-10 Channel (Model name: 75010R) (Required for each VRF Network)

Packing List

Type	For System controller		For System controller Lite				
	System controller	Option Energy manager	System controller Lite	Remote access	Option Electricity charge apportionment	Option Energy saving	Option Central Control
Model name	UTY-APGXZ1	UTY-PEGXZ1	UTY-ALGXZ1	UTY-PLGXR2	UTY-PLGXA2	UTY-PLGXE2	UTY-PLGXX2
White-USB-key	1	1	1	1	1	1	1

*1: Software protection key to be inserted in a USB slot running System controller or System controller Lite. System controller or System controller Lite may only run on a Computer with a White-USB-key. However, a White-USB-key is not required for remote VRF Explorer software.

Light Commercial & Commercial, Residential CONTROL SYSTEM & OPTIONAL PARTS

- C-002 Control System Overview
- C-006 Best Control Solution for Each Building Structure
- C-008 Comparison Table of Controllers
- C-054 Optional Parts Overview

A wide product lineup to meet a variety of needs

We can flexibly meet customer needs through a variety of offerings including wired and wireless individual remote controllers, central remote controllers that simultaneously control multiple indoor units, and a variety of converters that link with other systems.

CONTROL SYSTEM



INDIVIDUAL CONTROL

- C-010 Wired Remote Controller (with touch panel)
- C-012 Wired Remote Controller Compact Wired Remote Controller
- C-013 Simple Remote Controller

CONVERTERS/ADAPTERS

- C-014 WLAN Adapter
- C-015 MODBUS® Converter KNX® converter
- C-016 MODBUS® Interface
- C-017 KNX® Interface
- C-018 WLAN Adapter
- C-019 Multi-split Protocol WLAN Adapter
- C-020 BACnet® Gateway External switch controller



INDIVIDUAL CONTROL

- C-021 Wired Remote Controller
- C-022 Wireless Remote Controller
- C-023 IR Receiver Unit

CENTRALIZED CONTROL

- C-024 Central Remote Controller

CONVERTERS/ADAPTERS

- C-025 Network Converter for Single-Split Type



INDIVIDUAL CONTROL

- C-026 Wireless Remote Controller IR receiver unit for Duct and Cassette type

CENTRALIZED CONTROL

- C-028 Central Remote Controller
- C-030 Touch Panel Controller
- C-034 System Controller **Software** System controller Lite **Software**

CONVERTERS/ADAPTERS

- C-038 BACnet® Gateway **Software**
- C-039 BACnet® Gateway **Hardware** Multiple protocol LAN adapter
- C-040 BACnet®/MODBUS® Router
- C-041 BACnet®/MODBUS® Cloud Device
- C-042 MODBUS® Converter
- C-043 KNX® Converter
- C-044 Signal Amplifier Network Converter for LONWORKS®

- C-046 Control System List

Optional parts



- C-056 Silver Ion Filter
- C-057 Auto Louver Grille Kit



- C-058 Pressure Sensor Kit
- C-059 External Power Supply Unit

- C-059 AIR BEAM Radiation air outlet unit
- C-060 Optional Parts List
- C-064 Function List
- C-068 Separation Tube and other piping products



SPLIT



MULTI-SPLIT



VRF J Series



VRF V Series

Control System Overview

for Split & Multi-split

All indoor units* are equipped with a wireless or wired remote controller as standard. Additional options are available, such as individual remote controllers and central remote controllers. The easy-to-operate central remote controller makes it simple to control the operation mode, temperature, airflow volume, timer, and other functions of each indoor unit from a single location.

* Except for some products



Air Conditioning Individual control



Wired remote controller
A built-in thermo sensor monitors and controls room temperature accurately.



Wireless remote controller
Simple and versatile operations with a choice of 4 different types of timers



Simple remote controller
Compact remote controller with basic functionality

For Ceiling type



IR receiver unit

For Duct type

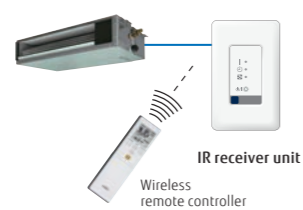

IR receiver unit

For Cassette type



IR receiver unit

This IR receiver unit enables a wireless remote controller to control a duct-type indoor unit.

Air Conditioning Centralized control



Central remote controller for 5, 6 & 8-unit Multi-split type
Enables individual and central control.



Converters/Adapters

For external control via BMS/Home Automation Systems

MODBUS® converter for indoor units
UTY-VMSX



MODBUS® interface for indoor units



KNX® converter for indoor units
UTY-VK SX



KNX® interface for indoor units



WLAN adapter



Network converter

DC power supply type
UTY-VTGX



AC power supply type
UTY-VTGXV



Online Control (Wireless Control via Smartphone/Tablet)

With the WLAN adapter and the FGLair app, you can control the heating and cooling of your home anytime, anywhere.

WLAN adapter

The dedicated WLAN adapter enables the air conditioner to be operated by smartphone or tablet computer from outside the home.



Simple, user-friendly interface design

The designed screen display makes it easier than ever to operate.

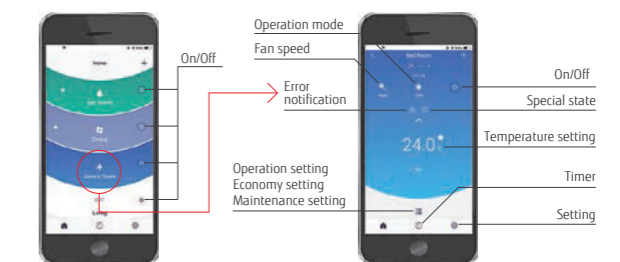

Control System Overview

for VRF

To meet the diverse needs of customers, we offer a variety of control options for our VRF systems, such as individual control, centralized control, and building management system (BMS) options.

Air Conditioning Individual control

Wired remote controller (with touch pane)
UTY-RNRYZ5

Wired remote controller
UTY-RLRY

Compact wired remote controller
UTY-RCRYZ1

Simple remote controller
UTY-RSRY
UTY-RHRY
Without operation mode

Wireless Remote Controller
UTY-LNHY

IR receiver unit
UTB-YWC for duct type

For Duct type
For One-way flow cassette Series/
3D-flow cassette Series/duct type

UTY-TRHX for One-way flow cassette Series
3D flow cassette Series/duct type

For Cassette type
For Circular flow cassette Series

UTY-LRHYB1 for cassette type
UTY-LBHDXD for Circular flow cassette Series

Air Conditioning Centralized control

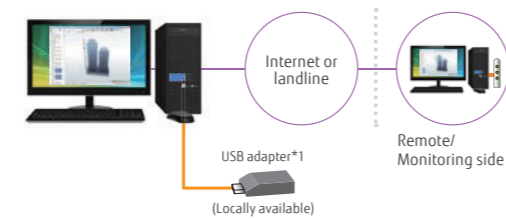

System controller (Software)
UTY-APGXZ1/UTY-ALGXZ1 (Lite version)

Up to **1600**^{*2}
Indoor units

*1: Echelon® U10 USB Network Interface
*2: The Lite version controls up to 400 indoor units.



Touch panel controller
UTY-DTGYZ1

Up to **400**
Indoor units

Central remote controller
UTY-DCGYZ2

Up to **100**
Indoor units



Converters/Adapters

For external control via BMS/Home Automation Systems

BACnet® gateway
UTY-ABGXZ1 (Software)



BACnet® gateway
(Hardware)



Network converter
(For LONWORKS®)
UTY-VLGX

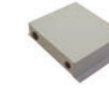

MODBUS® converter
for indoor units
UTY-VMSX



MODBUS® converter



KNX® converter
for indoor units
UTY-VKSX



KNX® converter
for VRF



WLAN adapter
UTY-TFSXZ1



External switch controller
UTY-TERX



Card-key
(Locally available)



Internet device

BMS/BAS^{*3}



BMS, Home automation system^{*3}



*3: BMS/BAS: Building Management System/Building Automation System

Converters/Adapters for system expansion

Network converter
DC power supply type
UTY-VTGX

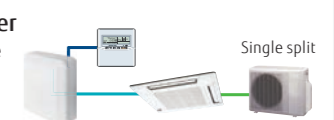

Network converter
AC power supply type
UTY-VTGXV



Signal amplifier
UTY-VSGXZ1



Best control solution for each building structure

Fujitsu General provides the best control solutions suitable for various building structures.

SHOP

Type	Individual control			Centralized control			Integrating control (Interface)		
	Wired remote controller	Group remote controller	Central remote controller	Touch panel controller	System controller	Network converter for LONWORKS®	MODBUS® Converter	KNX® converter	
	UTY-RNRYZ5 UTY-RLRY UTY-RVNYM UTY-RCRYZ1	UTY-CGGY	UTY-DCGYZ2	UTY-DTGYZ1	UTY-APGXZ1 UTY-ALGXZ1	UTY-VLGX	UTY-VMGX	UTY-VKGX	
Automatic control of air conditioning (Schedule timer, Weekly timer, etc.)	•	•	•	•	•				
Controls limited to staff: Remote controller prohibition, Setting temperature range limitation, etc.			•	•	•	•	•	•	
Group control		•	•	•	•				
Advanced energy saving: Peak cut, Operation of indoor unit rotation, etc.					•				
Remote monitoring management			•	•	•				
Manage multiple sites			•	•	•				
Monitor energy consumption					•				
Control third-party products					•				
Integrate Fujitsu General air conditioning into BMS						•	•	•	















HOTEL

Type	Individual control			Centralized control			Integrating control (Interface)				
	Wired remote controller	Simple remote controller	Wireless remote controller	Central remote controller	Touch panel controller	System controller	BACnet® gateway	Network converter for LONWORKS®	MODBUS® converter	KNX® converter	External switch controller
	UTY-RNRYZ5 UTY-RLRY UTY-RCRYZ1	UTY-RSRY UTY-RHRY UTY-RSNYM	UTY-LNHY UTY-LNTY	UTY-DCGYZ2	UTY-DTGYZ1	UTY-APGXZ1 UTY-ALGXZ1	UTY-ABGXZ1 UTY-VBGX	UTY-VLGX	UTY-VMGX	UTY-VKGX	UTY-TERX
Local control for hotel guests	•	•	•								
Centralized air conditioning control for common areas				•	•	•	•	•	•	•	
Limited control for hotel guests				•	•	•	•	•	•	•	
Remote monitoring management				•	•	•					
Advanced energy saving: Peak cut, Operation of indoor unit rotation, etc.						•	•				
Monitor energy consumption						•					
Control third-party products						•					
Integrate Fujitsu General air conditioning into BMS							•	•	•	•	
Interlock with window contact											•
Interlock with key card											•

OFFICE

Type	Individual control			Centralized control			Integrating control (Interface)				
	Wired remote controller	Simple remote controller	Wireless remote controller	Central remote controller	Touch panel controller	System controller	BACnet® gateway	Network converter for LONWORKS®	MODBUS® converter	KNX® converter	External switch controller
	UTY-RNRYZ5 UTY-RLRY UTY-RCRYZ1	UTY-RSRY UTY-RHRY UTY-RSNYM	UTY-LNHY UTY-LNTY	UTY-DCGYZ2	UTY-DTGYZ1	UTY-APGXZ1 UTY-ALGXZ1	UTY-ABGXZ1 UTY-VBGX	UTY-VLGX	UTY-VMGX	UTY-VKGX	UTY-TERX
Local control for office staff	•	•	•	•							
Automatic control of air conditioning (Schedule timer, Weekly timer, etc.)	•		•	•	•	•	•				
Centralized air conditioning control for management				•	•	•	•	•	•	•	
Controls limited to staff: Remote controller prohibition, Setting temperature range limitation, etc.				•	•	•	•	•	•	•	
Advanced energy saving: Peak cut, Operation of indoor unit rotation, etc.						•	•				
Remote monitoring management				•	•	•					
Electricity charge apportionment					•	•	•				
Monitor energy consumption						•					
Control third-party products						•					
Integrate Fujitsu General air conditioning into BMS							•	•	•	•	
Interlock with door contact											•
Interlock with Human sensor for meeting room				•							•

Comparison table of controllers

Item																
Model name	UTY-RNRYZ5	UTY-RLRY	UTY-RVNYM	UTY-RCRYZ1	UTY-RSNYM	UTY-RSRY		UTY-RHRY	UTY-LNHY	UTY-LNTY	UTY-DMMYM	UTY-DCGYZ2	UTY-DTGVZ1	UTY-ALGXZ1	UTY-APGXZ1	
Maximum number of controllable remote controller groups	1	1	1	1	1	1		1	1	1	1	100	400	400	1600	
Maximum number of controllable indoor unit	16	16	16	1	16	16		16	16	16	8	100	400	400	1600	
Maximum number of controllable group	-	-	-	-	-	-		-	-	-	-	50	400	400	1600	
Air conditioning control functions	ON/OFF	●	●	●	●	●		●	●	●	●	●	●	●	●	
	Operation mode setting	●	●	●	●	●		-	●	●	●	●	●	●	●	
	Fan speed control	●	●	●	●	●		●	●	●	●	●	●	●	●	
	Room temperature setting	●	●	●	●	●		●	●	●	●	●	●	●	●	
	Setting temperature range limitation	●	●	●	-	-		●	-	-	-	●	●	●	●	
	Test operation	●	●	●	●	●		●	●	●	-	-	●	-	-	
	Vertical louver setting	●	●	●	●	-		●	●	●	-	-	●	●	●	
	Horizontal louver setting	●	●	●	●	-		-	●	-	-	-	●	●	●	
	Individual louver control	●	-	-	●	-		-	-	-	-	-	●*3	●	-	
	Group setting	-	-	-	-	-		-	-	-	-	-	●	●	●	
	Remote controller prohibition	-	-	-	-	-		-	-	-	-	●	●	●	●	
	Anti-freeze setting	●	-	-	●	-		-	-	-	-	●	●	●	●	
	Set temperature auto return	●	●	●	-	-		-	-	-	-	-	●	-	-	
	Economy mode setting	●	●	●	●	-		-	●	●	●	●	●	●	●	
	Human sensor control	●	-	-	-	-		-	-	-	-	●	●	●	●	
Displayed items	Error	●	●	●	●	●		●	-	-	●	●	●	●	●	
	Defrosting	●	●	●	●	●		●	-	-	-	●	●	●	●	
	Current time	●	●	●	-	-		-	●	●	●	●	●	●	●	
	Day of week	●	●	●	-	-		-	-	-	-	●	●	●	●	
	Remote controller prohibition	●	●	●	●	●		●	-	-	●	●	●	●	●	
	Address display	●	●	●	●	●		●	-	-	-	-	●	●	●	
	Room temperature	●	-	●	●	-		●	-	-	-	●*4	●*4	●*4	●*4	
	Multiple language support	●	-	●	-	-		-	-	-	●	●	●	●	●	
	Setting for daylight saving time	●	-	●	-	-		-	-	-	●	●	●	●	●	
	Name registration	●	-	-	-	-		-	-	-	-	●	●	●	●	
	Backlighting	●	-	●	●	●		●	-	-	●	●	●	-	-	
	2D floor layout/3D building display	-	-	-	-	-		-	-	-	-	-	-	-	●	
	Refrigerant leak detector	-	-	-	-	-		-	-	-	-	●	●	●	●	
	Timer	Schedule timer	Period	Week	Week	Week	-		-	-	-	Week	Week	Year	Year	Year
			ON/OFF, Temp, Mode, Times per day	8	4	8	-		-	-	-	4	20	20	144	144
ON/OFF timer		●	●	●	●(OFF only)	-		-	●	●	-	-	-	-	-	
Sleep timer		-	-	-	-	-		-	●	●	-	-	-	-	-	
Program timer		-	-	-	-	-		-	●	●	-	-	-	-	-	
Auto-off timer		●	●	●	-	-		-	-	-	-	●	●	-	-	
Day off		●	●	●	-	-		-	-	-	●	●	●	●	●	
Minimum unit of timer setting (minutes)	10 • 30	30	30	-	-		-	5	5	5	10	10	10	10		
Control	Remote monitoring management system	-	-	-	-	-		-	-	-	-	●	●	●	●	
	Electricity charge apportionment	-	-	-	-	-		-	-	-	-	-	○	○	●	
	Error history	●	●	●	-	-		-	-	-	-	●	●	●	●	
	Emergency stop	-	-	-	-	-		-	-	-	-	●*2	●*2	-	-	
	Remote monitoring management	-	-	-	-	-		-	-	-	-	●	●	○	●	
	Energy-saving management	-	-	-	-	-		-	-	-	-	-	-	○	○	
	E-mail notification in case of failure	-	-	-	-	-		-	-	-	-	●	●	●	●	
	Key lock	● Child lock	● Child lock	● Child lock	-	-		-	-	-	-	● Child lock	● Password setting	● Password setting	● Password setting	● Password setting
	Low noise mode	-	-	-	-	-		-	-	-	-	●	●	●	●	
	Multi System Control	●	-	-	-	-		-	-	-	-	-	-	-	-	

*1 "Operation mode" setting not available. *2 Available only for external input control.
 *3 Equipped only with individual air volume batch reset. *4 Available only when using Wired remote controller.
 ●: Supported ○: Optional function -: Unsupported

Wired remote controller (with touch panel)

UTY-RNRYZ5



NEW



Easy operation due to large high-resolution STN-LCD touch panel screen

- Touch screen LCD
- Built-in daily/weekly timer (ON/OFF, temperature, modes)
- Backlit screen for easy operation in the dark.
- Room temperature display
- Controls up to 16 indoor units
- Supports 12 languages: Chinese, Dutch, English, French, German, Greek, Italian, Polish, Portuguese, Russian, Spanish, and Turkish
- nonpolar 2-core type

Up to 16 indoor units

Up to 1 group

High performance and compact size

A single remote controller controls each connected indoor unit and provides a weekly timer function and a variety of energy-saving options.



Accurate control for comfort

A thermo sensor built into the remote controller monitors room temperature accurately.

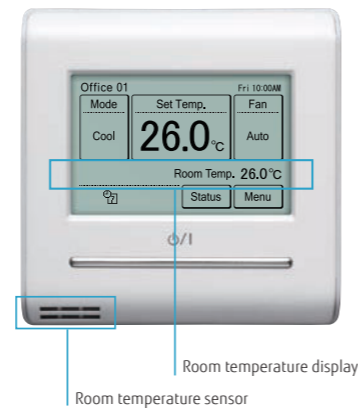

Energy saving controls

Custom Auto

- Maintains 2 separate setpoints for heating and cooling operations.
- Automatically switches between heating and cooling modes.

* Not available for some models

Auto-off timer

- While the Auto-timer is activated, if the set off time is specified as, for example, one hour, the power will automatically turn off one hour after the start of operation.
- A desired time frame can be specified for the Auto-off timer.
- The off-time can be set from 30 to 240 minutes.

2-setting weekly timer

Set temperature auto return

Setting temperature range limitation

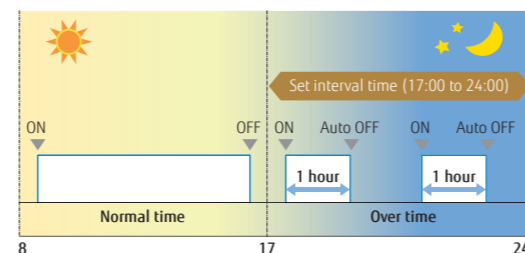
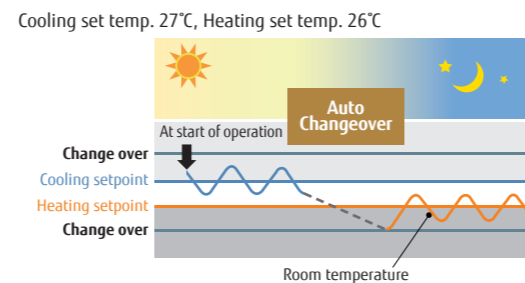

e.g.) Between 17:00 and 24:00 (over time hours), when the 1 hour set off time has elapsed, the system will automatically turn off the indoor unit as it

Features: Wired Remote Controller (Touch Panel)

NEW Multi System Control*1 *2

1) Lead Lag Operation

Standby Indoor Unit can be selected in lead lag operation. By this, the Indoor units will last longer than operating by nonstop.



*1: It is necessary to select an indoor unit when actually operating in the server room.
*2: It is not a function that guarantees the server will not fail.

*XX

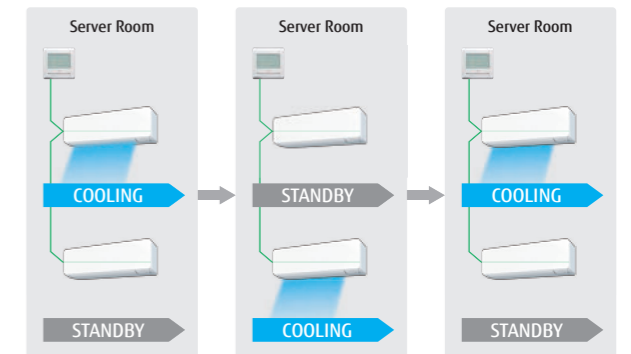

Example and Control Functions

Operation mode: Cooling
Setting temp.: 24°C
Airflow: High
Max. No. indoor units: depends on indoor unit
No. of Standby IDUs*: 1 or 2 units
Rotation Interval: 1-7 days
Operation Overlap Time*: None / 10 / 20 / 30 min

*No. of Standby Indoor units and operation overlap time can be changed from wired remote controller.

2) Back up operation

In case of unexpected Indoor unit error, other Indoor units will start providing back up operation.

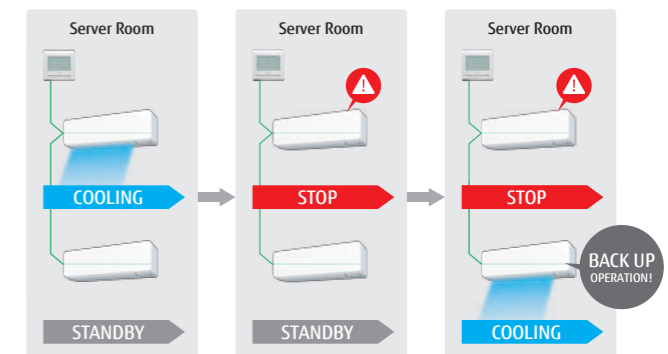

Example and Control Functions

Operation mode: Cooling
Setting temp.: 24°C
Airflow: High
Max. No. indoor units: depends on indoor unit
No. of back-up IDUs*: 1 or 2 units

*No. of back-up Indoor units can be changed from wired remote controller.

3) Lag Operation

In case of unexpected Indoor unit error, other Indoor units will start providing back up operation.

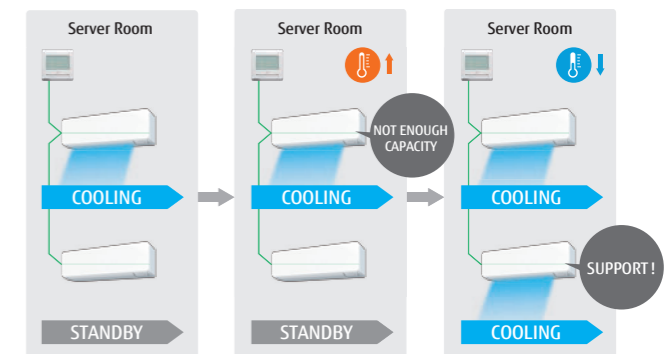

Example and Control Functions

Operation mode: Cooling
Setting temp.*: 24°C
Support Operation Start: 26.5°C (setting temp +2.5°C)
Support Operation Stop: 24.5°C (setting temp +0.5°C)

*Setting temperature can be changed from wired remote controller.

Specifications

Model name	UTY-RNRYZ5
Power Source	DC 12 V
Dimensions (H × W × D) (mm)	120 × 120 × 20.4
Weight (g)	220

DC 12 V is supplied by the indoor unit.

Wired remote controller

UTY-RLRY



- ON/OFF/Weekly timer settings
- A built-in thermo sensor monitors and controls room temperature accurately.
- When something goes wrong, an error code is displayed.
- 16 error codes from the most recent one will be kept in the history. (Last 16 error codes can be accessed)
- nonpolar 2-core type

High performance and compact size

A single remote controller controls each connected indoor unit and provides a weekly timer function and a variety of energy-saving options.



Up to 16 indoor units

Up to 1 group

Visually intuitive operation

- The operation mode, set temperature, and fan speed are shown prominently on the top screen.
- Each function to be set is indicated by an icon.
- The control guide makes it simple and straightforward to operate a remote controller.

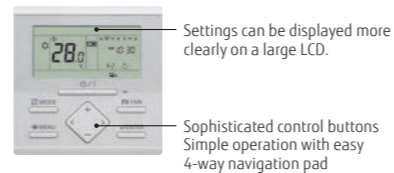

Compact wired remote controller

UTY-RCRYZ1

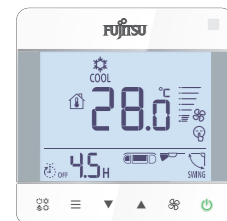

- Simple design that matches stylish interiors
- The body of the controller, which is easy to install, is designed to conform to the European standard junction box.
- Can be operated both by wireless and wired remote controller.
- nonpolar 2-core type

Large screen and simple display

- Large screen but compact size
- Large, easy-to-read letters are used.
- The controls are simple and easy to understand.

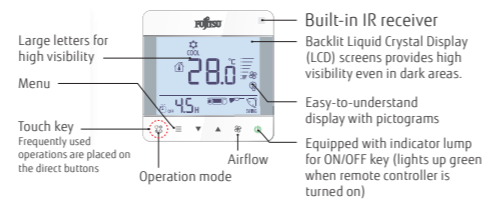

System overview

VRF connection

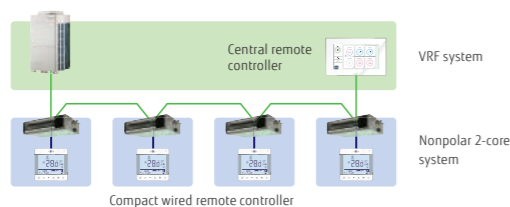

RAC connection

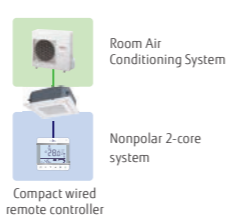

Specifications

Model name	UTY-RLRY	UTY-RCRYZ1
Power source	12 V DC	12 V DC
Dimensions (H × W × D) (mm)	120 × 120 × 17	86 × 86 × 44
Weight (g)	170	135

12 V DC supplied by an indoor unit

Simple remote controller

UTY-RSRV/UTY-RHRY (without operation mode)

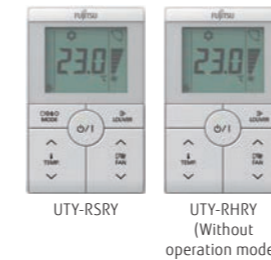

Compact remote controller with basic functionality

- Up to 16 indoor units can be controlled with one remote controller.
- Suitable for hotels or offices as it is easily operated with no complex functions.
- Simple design that matches stylish interiors
- Large LCD screen and easy-to-use control buttons
- Backlight: White backlight makes it easy to operate in the dark.
- nonpolar 2-core type

Up to 16 indoor units

Up to 1 group

Supports a variety of applications

- **Vertical louver control:** Adjusts the vertical airflow direction of a duct-type indoor unit with an auto louver or a cassette type installed in a hotel room or a conference room.
- **Setting temperature range limitation:** Enables an indoor unit to operate in an energy-saving manner in a small building not equipped with a central remote controller.
- **Built-in room temperature sensor:** Monitors and controls room temperature accuracy.

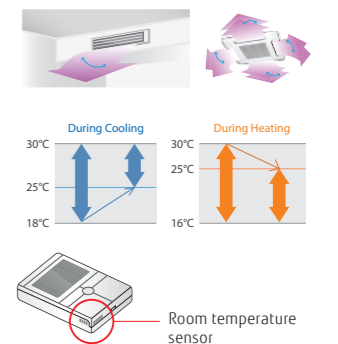

Simple remote controller

UTY-RSNYM, UTY-RSKY/UTY-RHKY (without operation mode)

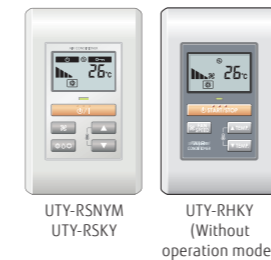

Compact remote controller with basic functionality

- Up to 16 indoor units can be controlled with one remote controller.
- Suitable for hotels or offices as it is easily operated with no complex functions.
- Backlit screen for easy operation in the dark.
- polar 3-core type

Up to 16 indoor units

Up to 1 group

Easy-to-use operation

- Enables basic control of an indoor unit, such as ON/OFF, fan speed, operation mode select, and room temperature setting.
- A large ON/OFF button is located in the middle for quick access.
- Works with other individual control units.
- When something goes wrong, an error indicator will appear, and diagnostics can be performed with the remote controller.

Specifications

Model name	UTY-RSRV	UTY-RHRY	UTY-RSNYM, UTY-RSKY	UTY-RHKY
Power source	12 V DC	12 V DC	12 V DC	12 V DC
Dimensions (H × W × D) (mm)	120 × 75 × 19.4	120 × 75 × 19.4	120 × 75 × 19.4	120 × 75 × 14
Weight (g)	120	120	120	90

12 V DC supplied by an indoor unit

WLAN adapter

UTY-TFNXZ1/UTY-TFSXZ1, UTY-TFSXW1, UTY-TFSXF2



USB type for single-split models
UTY-TFSXF2



UTY-TFNXZ1 (3-wire RC-line type) (CN connector type)
UTY-TFSXZ1 (CN connector type)

- This interface provides the most advanced solution for the remote management of an air conditioning system by using smartphones, tablets, and computers.
- No separate external power supply required
- Can be used for a single indoor unit and multi-split indoor units.

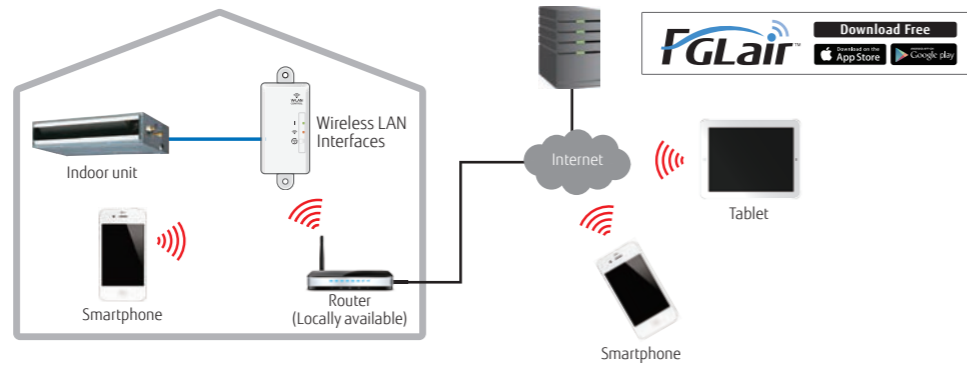

Up to
1 indoor unit

Basic control

- Turning the units on and off
- Mode control (Heat, Cool, Dry, Auto, Fan)
- Fan speed control
- Louver position (airflow direction setting)
- Timer operation setting (Weekly timer)
- Economy mode setting

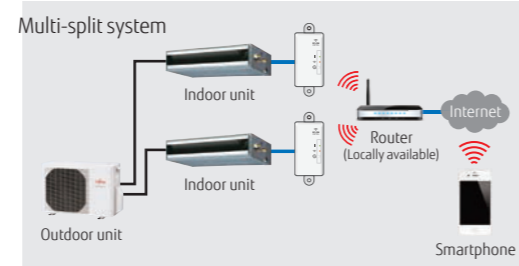

Multiple air conditioning management

- Manage multiple air conditioning systems in different locations.

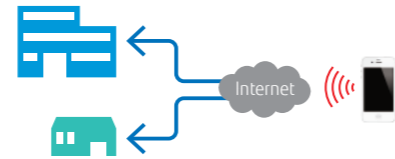

Error alert and e-mail notice

- E-mail notification alerts
- Air conditioning malfunction alert
- Enables quick service response when errors occur.

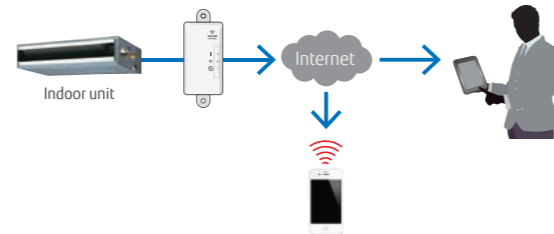

WLAN adapter (USB type) UTY-TFSXF2

A compact USB type is available. No need for specialized installation. Easily installed on the indoor unit.



Specifications

Model name	UTY-TFNXZ1 (3-wire RC-line type)	UTY-TFSXZ1 (CN connector type)	UTY-TFSXW1 (CN connector type)	UTY-TFSXF2
Dimensions (H × W × D) (mm)	71 × 38 × 15	71 × 38 × 15	71 × 38 × 15	56.7 × 34 × 9.72
Weight (g)	35	35	35	30

MODBUS® converter for Indoor unit

UTY-VMSX



Up to
1 indoor unit

MODBUS® converter enables air conditioners to be fully integrated into a MODBUS® network.

- Simple installation due to small and compact size.
- No separate external power supply required.
- The MODBUS® converter must be connected to an indoor unit on a one-to-one basis.
- The MODBUS® converter enables central monitoring and control of air conditioners from BMS, central, or home controller.

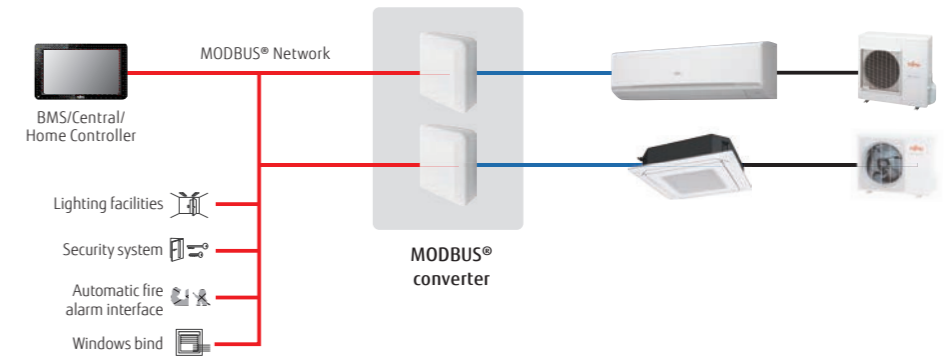

Basic control

- Turning the units on and off
- Mode control (Heat, Cool, Dry, Auto, Fan)
- Fan speed control
- Louver position (airflow direction setting)
- Room temperature setting and display
- Economy mode setting
- Error status

Easy Installation

Easy to install with minimal wiring and without the need for a power supply cable to the converter

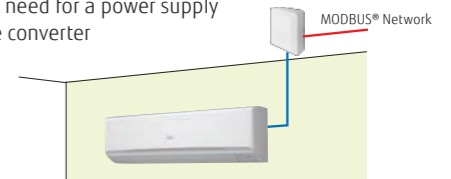

KNX® converter for indoor unit

UTY-VKSX



Up to
1 indoor unit

KNX® Converter enables individual control of an indoor unit.

- The new KNX® converter connects a central or home controller and a Fujitsu General indoor unit.
- Compact and lightweight design

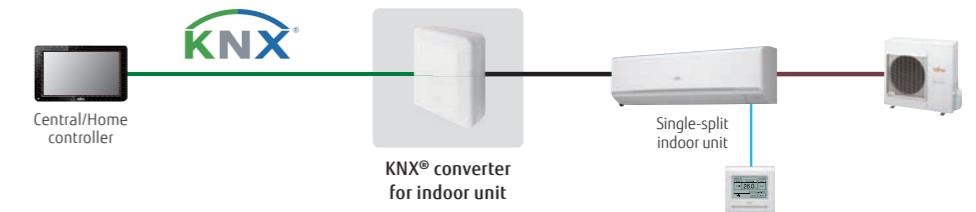

Specifications

Model name	UTY-VMSX
Power supply	12 V DC
Input power (W)	Max. 1.2 W
Dimensions (H × W × D) (mm)	140 × 117 × 43
Weight (g)	200
Maximum number of connectable indoor units per MODBUS® converter	1

Modbus communication specifications

Transfer mode	RTU mode
Communication speed	9600/19200 bps
Data bit	8
Parity	even/odd/none
Stop bit	1/2 (no parity)
Network	RS485
Maximum cable length	1000 m (3280 ft)

Model name	UTY-VKSX
Power supply	12 V DC
Power consumption (W)	0.6
Dimensions (H × W × D) (mm)	140 × 117 × 43
Weight (g)	215

MODBUS® interface

FG-RC-MBS1Z1/FG-AC-MBS1Z1



FG-RC-MBS1Z1
(3-wire RC-line type)

NEW



FG-AC-MBS1Z1
(CN connector type)

MODBUS® interface enables air conditioners to be fully integrated into a MODBUS® network.

- Small, compact, and easy to install on DIN rails.
- No separate external power supply required.
- MODBUS® interface enables central monitoring and control of air conditioners from BMS.

Installation example

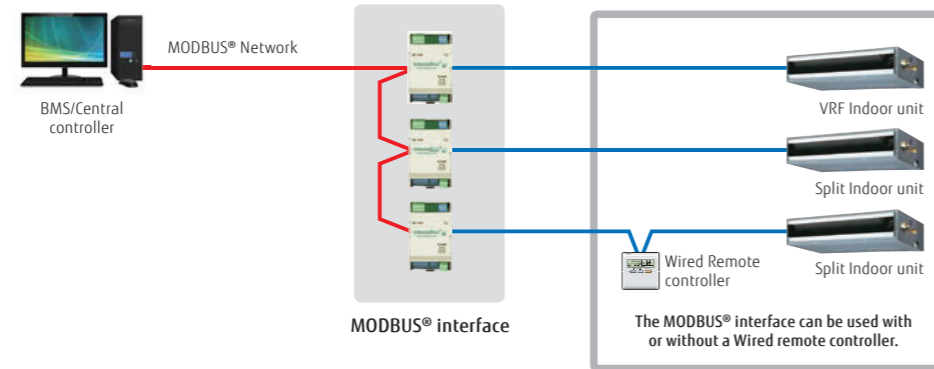

Up to
1 indoor unit

Specifications

Model name	FG-RC-MBS1Z1 (3-wire RC-line type)	FG-AC-MBS1Z1 (CN connector type)
Number of controllable groups	1	1
Dimensions (H × W × D) (mm)	93 × 53 × 58	93 × 53 × 58
Weight (g)	85	85

KNX® interface

FG-RC-KNX1Z1/FG-AC-KNX1Z1/FG-IR-KNX1Z1



FG-RC-KNX1Z1
(3-wire RC-line type)

NEW



FG-AC-KNX1Z1
(CN connector type)

NEW



FG-IR-KNX1Z1
(IR type)

Up to
1 indoor unit

The KNX® interface enables air conditioners to be fully integrated into a KNX® network system.

- Simple installation due to small and compact size.
- No separate external power supply required (only KNX® bus power required)

Installation example

[3-wire RC-line type/CN connector type]

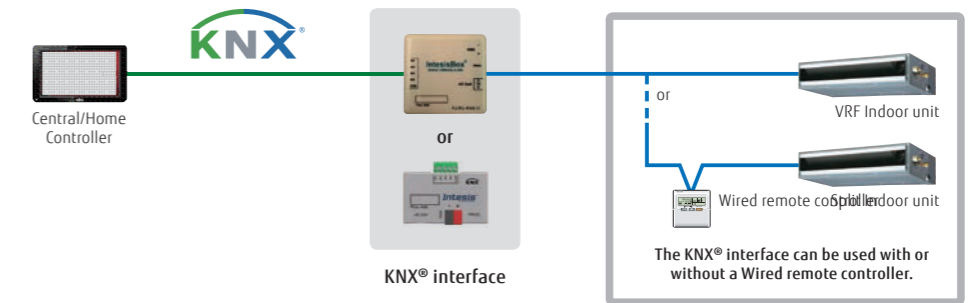

[IR type] Connection to wall-mounted type

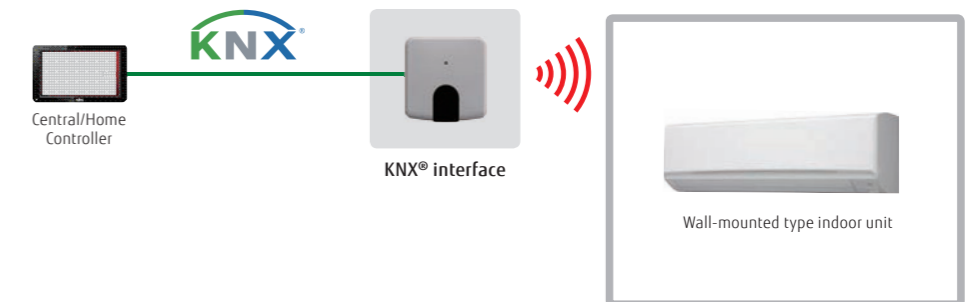

[IR type] Connection to a product other than wall-mounted type

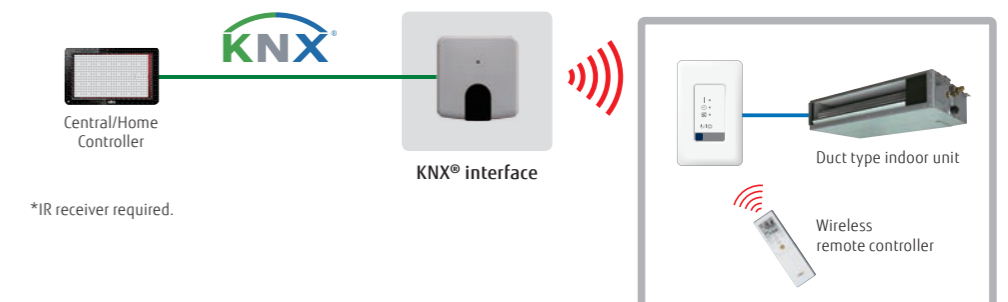

Specifications

Model name	FG-RC-KNX1Z1 (3-wire RC-line type)	FG-AC-KNX1Z1 (CN connector type)	FG-IR-KNX1Z1 (IR type)
Number of controllable groups	1	1	1
Dimensions (H × W × D) (mm)	70 × 70 × 28	45 × 59 × 21	81 × 78 × 28
Weight (g)	70	35	76



WLAN adapter

FG-RC-WIF1Z2/FG-IR-WIF1Z1/FG-AC-WIF1Z1



FG-RC-WIF1Z2
(3-wire RC-line type)

AC Cloud Control

- This interface provides the most advanced solution for the remote management of an air conditioning system by using smartphones, tablets, and computers.
- No separate external power supply required

Installation example

[3-wire RC-line type/CN connector type]

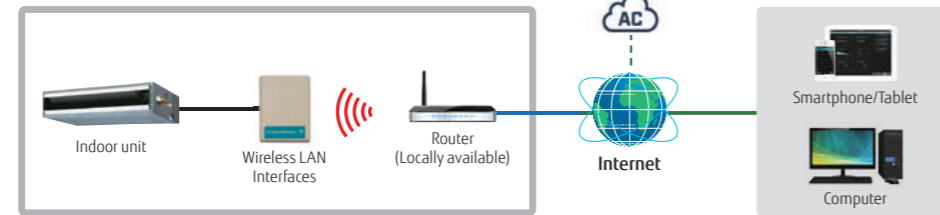

[IR type] Connection to wall-mounted type

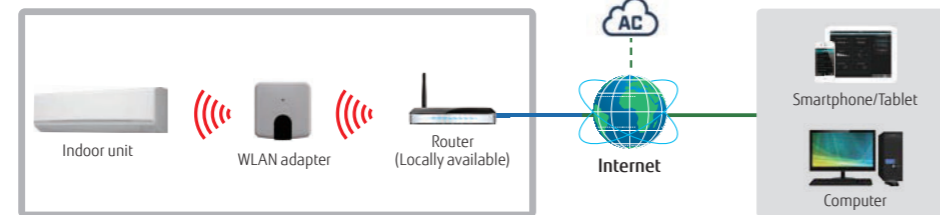

[IR type] Connects to the product with the optional receiver kit

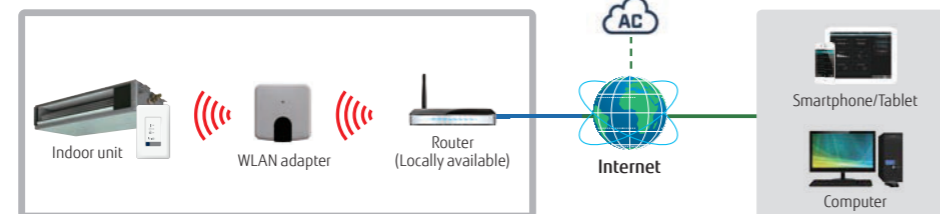

*IR receiver required.

Basic control

- Turning air conditioner on and off
- Mode select (Heat, Cool, Dry, Auto, Fan)
- Louver position (airflow direction setting)
- Fan speed control
- Room temperature display
- Setting temperature
- Multiple language support
- One single scene is created.

Advanced control (optional functions)

- Climate-based operation modes (ECO, Comfort, and Powerful) (to be available in the future)
- Schedule functions (ON/OFF, modes, set temperature, fan speed, louver position)
- Setting temperature range limitation
- Multiple Scenes and Calendars are created.
- Smart Speaker compatibility
- Advanced internet service connections

Notification and operation history

- E-mail notification alerts
- Air conditioning malfunction alert
- Connectivity monitoring and alert
- Operation history (to be available in the future)

Specifications

Model name	FG-RC-WIF1Z2 (3-wire RC-line type)	FG-AC-WIF1Z1 (CN connector type)	FG-IR-WIF1Z1 (IR type)
Number of controllable groups	1	1	1
Dimensions (H × W × D) (mm)	108 × 70 × 28	81 × 78 × 28	127 × 50 × 17
Weight (g)	80	76	80

Multiple protocol WLAN adapter

FG-RC-WMP1Z1/FG-IR-WMP1Z1/FG-AC-WMP1Z1



FG-RC-WMP1Z1
(3-wire RC-line type)

AC Cloud Control

- Air conditioner control of Home Automation systems via wireless LAN connection.
- No separate external power supply required

Installation example

[3-wire RC-line type/CN connector type]

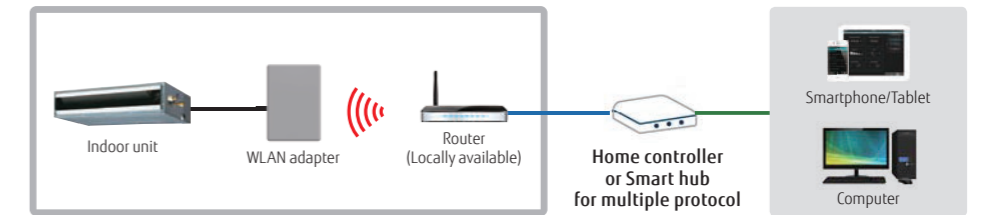

[IR type] Connection to wall-mounted type

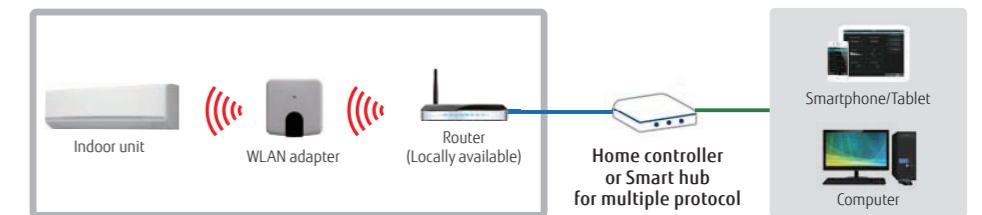

[IR type] Connection to a product other than wall-mounted type

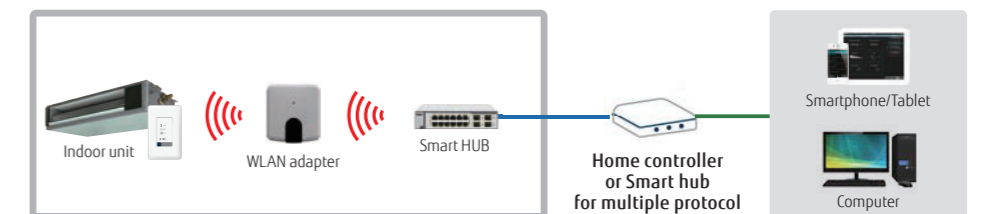

*IR receiver required.

Up to
1 indoor unit

Specifications

Model name	FG-RC-WMP1Z1 (3-wire RC-line type)	FG-AC-WMP1Z1 (CN connector type)	FG-IR-WMP1Z1 (IR type)
Number of controllable groups	1	1	1
Dimensions (H × W × D) (mm)	70 × 100 × 28	127 × 50 × 17	81 × 78 × 28
Weight (g)	98	80	76

BACnet® gateway

FG-AC-BAC1Z1



NEW



FG-AC-BAC1Z1 (CN connector type)

Up to 1 indoor unit

- BACnet® Gateway connects BMS and a Fujitsu General split/multi-split/VRF system.
- Compatible with BACnet® (ANSI/ASHRAE-135-2012) application-specific controller (B-ASC)
- Compatible with BACnet®/IP over Ethernet.

Installation example

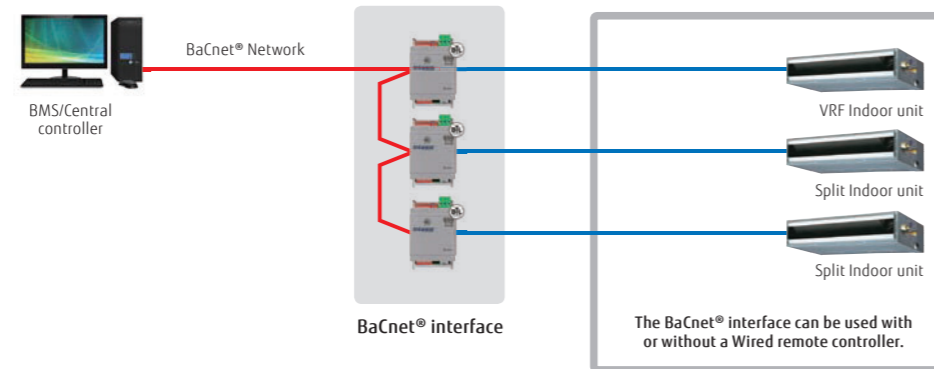

External switch controller

UTY-TERX



Up to 1 group

Air conditioner switching can be controlled by connecting this external switch controller to other sensor switches.

- In combination with a commercially available card-key switch or other sensors, this External switch controller enables the control of ON/OFF, room temperature, and fan speed of connected air conditioners as well as master control functions. This makes this product an ideal choice for use in hotel rooms.
- Card key or other sensor switches are locally available.
- The set temperature can be specified at two points each for cooling and heating operations (4 points in total).

Installation example

Human sensor monitors the movement of a person in a room. When it detects that the person has left the room, it switches the air conditioner to low-capacity mode. When a person returns to the room, the air conditioner returns to the previous operation mode.



Human sensor equipment needs to be purchased separately. Human sensor is not mounted on an External switch controller.

Specifications

Model name	UTY-TERX	FG-AC-BAC1Z1 (CN connector type)
Power supply	6.5 to 16 V DC	-
Dimensions (H × W × D) (mm)	140 × 117 × 43	93 × 53 × 58
Weight (g)	250	85

12 V DC supplied by an indoor unit

Wired remote controller

UTY-RVNYM



Up to 16 indoor units

Up to 1 group

Hi-grade individual control with a wide range of functions.

- 3.7-inch backlit LCD screen.
- Supports energy-saving functions with simple operation.
- Supports 9 languages: English, French, German, Greek, Italian, Portuguese, Russian, Spanish, and Turkish

Visually intuitive operation

- Each function is displayed as an icon.
- Main functions are indicated by large icons: "Mode," "Set Temp," and "Fan"
- Easy operation with control guide display
- Simple operation with easy 4-way navigation pad

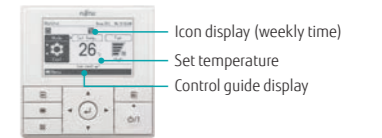

High performance and compact size

- A single remote controller controls each connected indoor unit and provides a variety of energy-saving options.



Energy-saving controls

Weekly Timer

- ON/OFF, mode and temperature can be set up to 8 times a day.
- 2 setting patterns are available (e.g., for Summer/Winter).

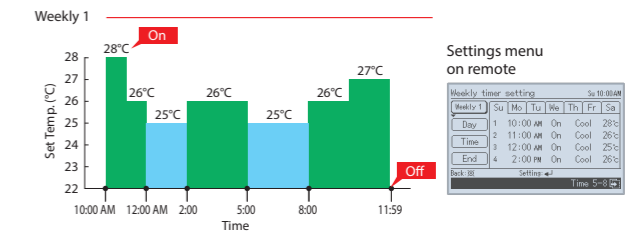

Auto-off timer

- Set temperature auto return
- Setting temperature range limitation

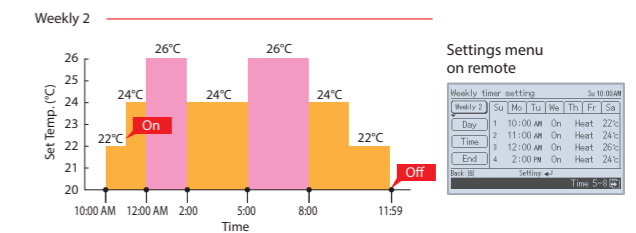

Specifications

Model name	UTY-RVNYM
Power source	12 V DC
Dimensions (H × W × D) (mm)	120 × 120 × 21.3
Weight (g)	220

12 V DC supplied by an indoor unit

Wired remote controller

UTY-RNNYM

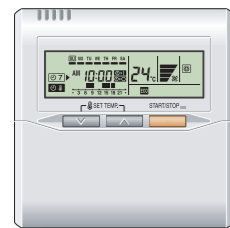

- Simple operation with Built-in Weekly/Daily Timer.
- Control up to 16 indoor units.
- Up to 2 Wired remote controllers can be connected to a single indoor unit.

Accurate control for comfort

A thermo sensor built into the remote controller monitors room temperature accurately. The wired remote controller and an optional Remote sensor can be installed in any location to meet any requirement.

Examples of sensor changes

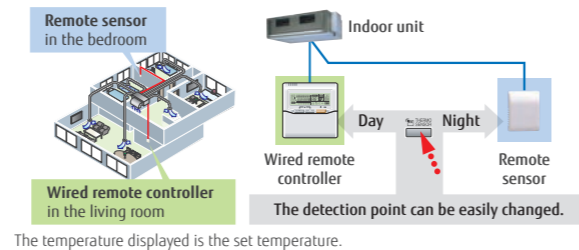

Up to
16 indoor units

Up to
1 group

Built-in timer

Weekly timer: ON/OFF time can be set to operate twice for each day of the week.
Temperature setback timer: Sets the time to change the temperature setting and the time to hold the setting for each day of the week.
At "Weekly timer" + "Temperature setback timer" setup

Wireless remote controller

UTY-LNTY



Simple and versatile operations with a choice of 4 different types of timers

- Controls up to 16 indoor units.

Built-in timer

4 timer programs: ON/OFF/Program/Sleep
Program timer: Sets ON/OFF time once for every 24 hours.
Sleep timer: Adjusts the set temperature automatically while the sleep timer is on.

Easy installation and operation

Different codes can be assigned to up to 4 indoor units to prevent a mix-up.
Wide and precise transmitting range

Up to
16 indoor units

Up to
1 group

Up to
4 different daily timers

Specifications

Model name	UTY-RNNYM	UTY-LNTY
Power source	12 V DC	5 V DC
Dimensions (H × W × D) (mm)	120 × 120 × 18	145 × 90 × 30
Weight (g)	160	150

12 V DC supplied by an indoor unit

IR receiver unit for duct type

UTY-LRHYM, UTY-LBTYM

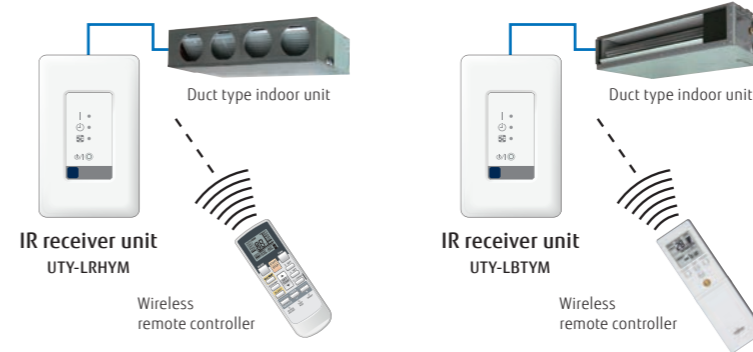

The wireless remote controller controls duct type indoor units.

IR receiver unit for Cassette

UTY-LRHYA2, UTY-LBTYC

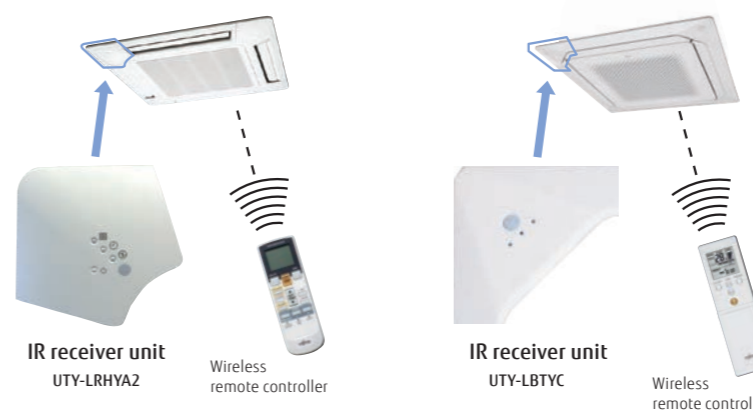

Cassette type indoor unit can be controlled with a Wireless remote controller.

IR receiver unit for ceiling type

UTY-LBTYH



The wireless remote controller controls ceiling type indoor units.

Specifications

Model name	UTY-LRHYM	UTY-LBTYM	UTY-LRHYA2	UTY-LBTYC	UTY-LBTYH
Battery	5 V DC	5 V DC	5 V DC	5 V DC	5 V DC
Dimensions (H × W × D) (mm)	145 × 90 × 30	145 × 90 × 30	193.9 × 193.9 × 31.2	193.9 × 193.9 × 31.2	174.8 × 48.6 × 23.1
Weight (g)	150	150	140	140	100

12 V DC supplied by an indoor unit

Central remote controller

UTY-DMMYM/UTY-DMMYM1

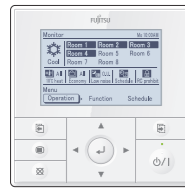

Up to 1 multi-split system

Up to 8 indoor units

For 5-unit, 6-unit, 8-unit multi-split type

- Batched control of up to 8 indoor units For all indoor units connected to the remote controllers, the Central remote controller sets room temperature, airflow volume, and remote controller prohibition from other remote controllers at once.
- Supports 9 languages: English, French, German, Greek, Italian, Portuguese, Russian, Spanish, and Turkish.
- Large backlit LED screen
- Large, easy-to-see operation panel

Example of system configuration

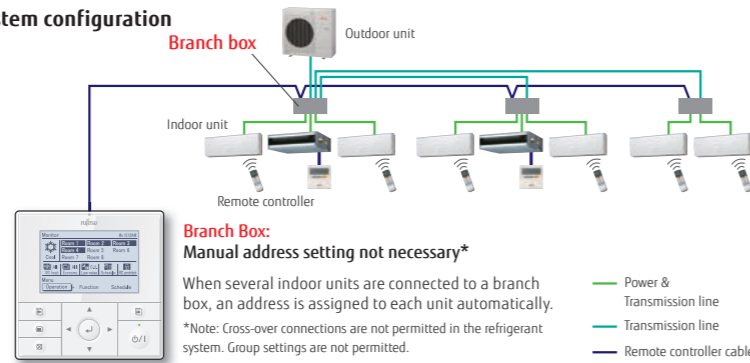

Central remote controller

Weekly timer

Up to 4 ON/OFF settings can be programmed per day. Two weekly patterns can be set, one for the cooling season and the other for the heating season.

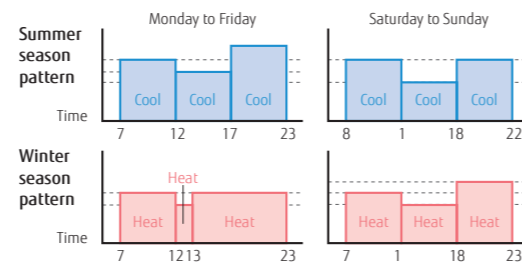

Low noise operation

You can choose from 4 low noise levels depending on the installation environment. ON/OFF timing of low noise mode can be set with the timer.

10°C heat operation

When you leave the house, the air conditioner runs a minimum heating operation to maintain the room temperature at 10°C.

*Consult your dealer for conditions of use.

Economy operation

When you select energy-saving economy mode, the temperature setting for the indoor unit increases (during cooling operation) or decreases (during heating operation) by 1°C and the maximum electric value of the outdoor unit is suppressed.

Prohibiting local control, including settings such as child lock

The Central Remote Controller is equipped with a lock function to prevent unauthorized operation from the remote controllers of the indoor unit in each room. The central remote controller is equipped with a child lock to prevent children from accidentally turning the air conditioner on or off or changing its settings.

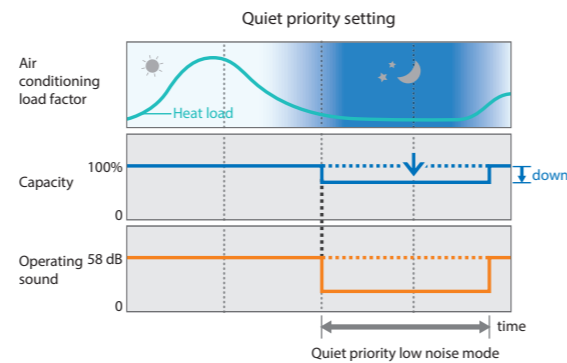

Specifications

Model name	UTY-DMMYM/UTY-DMMYM1
Power source	12 V DC
Dimensions (H × W × D) (mm)	120 × 120 × 21.3
Weight (g)	220

12 V DC supplied by an indoor unit

Network converter for single-split type

UTY-VTGX/UTY-VTGXV



UTY-VTGX
DC power supply type



UTY-VTGXV
AC power supply type

- A network converter is required when connecting a single-split system to a VRF network system.
- Compact and lightweight design
- Connectable to both nonpolar 2-core and polar 3-core remote controllers

Installation example

- A 1-remote-controller type and a 2-remote-controller type are available.
- Power supply (220 to 240 V AC, 50/60 Hz) is required for the 2-remote-controllers type.

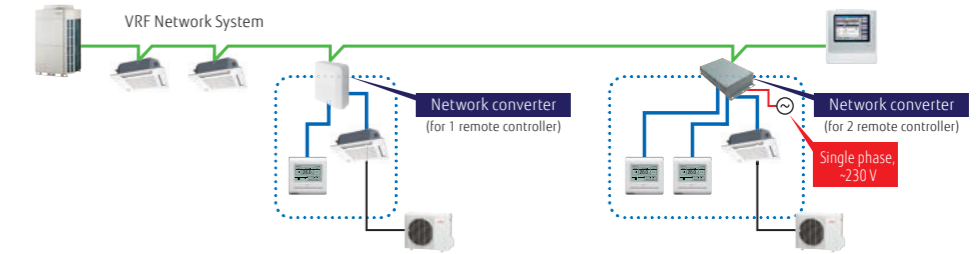

Up to 16 single indoor units

Up to 1 group

Up to 100 Network Converters

- Both nonpolar 2-core and polar 3-core type Wired remote controllers can be connected.

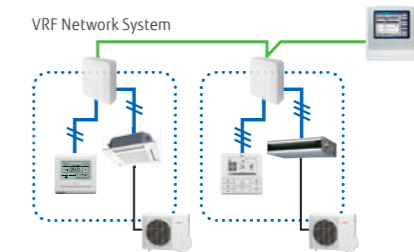

- Central control can be provided for single-split systems. (Up to 100 network converters can be connected in a VRF network system)

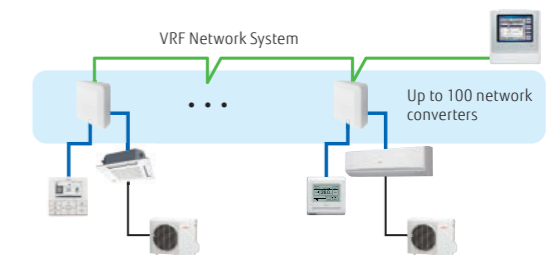

Specifications

Model name	UTY-VTGX	UTY-VTGXV
Power supply	polar 3-core 12 V DC	nonpolar 2-core DC 12 V
Input power (W)	Max. 1.2 W	
Dimensions (H × W × D) (mm)	140 × 117 × 43	54 × 260 × 150
Weight (g)	250	1,100

Wireless remote controller

UTY-LNHY



Simple and versatile operations with a choice of 4 different types of timers

- Controls up to 16 indoor units.

Built-in timer

4 timer programs: ON/OFF/Program/Sleep
 Program timer: Sets ON/OFF time once for every 24 hours.
 Sleep timer: Adjusts the set temperature automatically while the sleep timer is on.

Easy installation and operation

Different codes can be assigned to up to 4 indoor units to prevent a mix-up.
 Wide and precise transmitting range

Up to
16 indoor units

Up to
1 group

Up to
4 different daily timers

IR receiver unit for duct type

UTB-YWC, UTY-TRHX

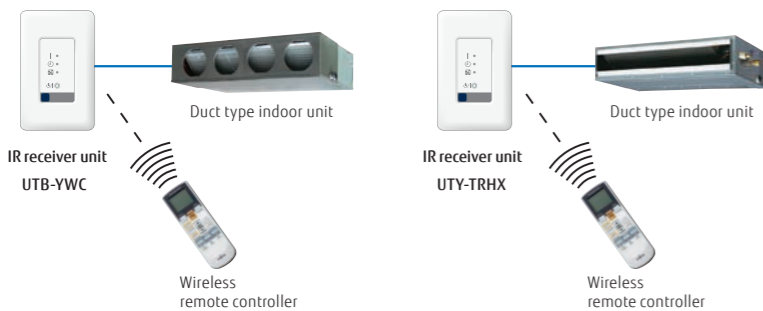

The wireless remote controller controls duct type* indoor units.

*Large airflow duct types do not work with this IR receiver unit.

*A separate wireless remote control (model: UY-LNHY) is required.

IR receiver unit for Cassette

UTY-LRHYB1, UTY-LBHxD, UTY-TRHX

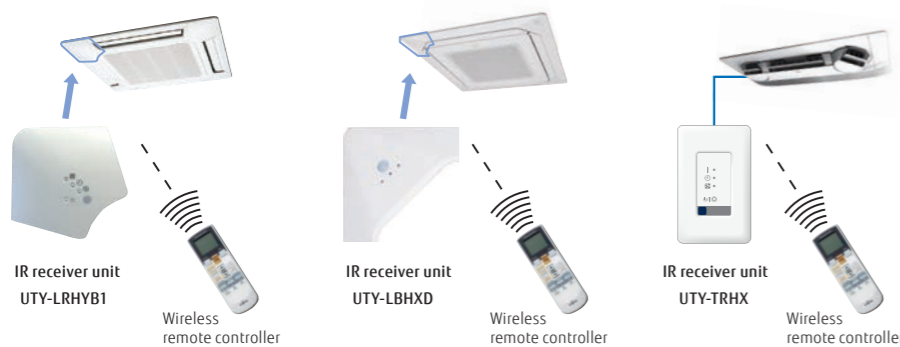

Cassette type indoor unit can be controlled with a Wireless remote controller.

*A separate wireless remote control (model: UY-LNHY) is required.

Specifications

Model name	UTY-LNHY	UTB-YWC	UTY-LRHYB1	UTY-LBHxD	UTY-TRHX
Battery	1.5 V (R03/LR03/AAA) × 2	5 V DC	5 V DC	5 V DC	5 V DC
Dimensions (H × W × D) (mm)	170 × 56 × 19	145 × 90 × 30	193.9 × 193.9 × 31.2	193.9 × 193.9 × 31.2	145 × 90 × 30
Weight (g)	85	150	140	140	150

12 V DC supplied by an indoor unit



Central Remote Controller

UTY-DCGYZZ



NEW



For tenants in small to midsize commercial premises

- Individual control and monitoring of up to 100 indoor units
- 7.0inch TFT color screen
- Visually intuitive operation
- Room temperature display by indoor unit sensor & remote controller sensor
- 50 Remote Controller Groups Display & remote controller group rename
- Supports 12 languages: Chinese, Dutch, English, French, German, Greek, Italian, Polish, Portuguese, Russian, Spanish, and Turkish

Up to 100 indoor units

Up to 50 groups

Easy Operation

Air conditioning management by detecting room temperatures of each room

The room temperature detected with indoor unit sensor or remote controller sensor can be displayed. New model can detect the room temperature by indoor units sensors even if wired remote controllers are not connected to the indoor units.

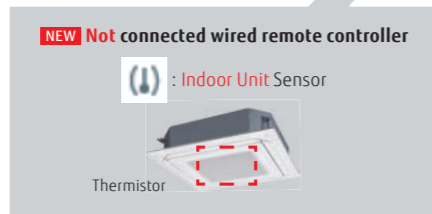

*Room temperature is displayed only when indoor unit operates.

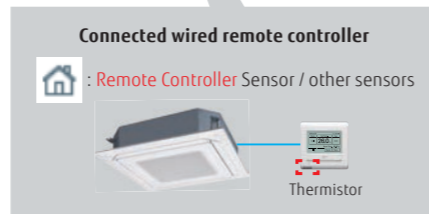

NEW 50 Remote Controller Groups Display

The group display and the 50 remote controller groups display can be switched easily. Users can choose which display is better, depending on the situation.

Group Display



Manage & Monitor by each Groups

50 Remote Controller Groups Display

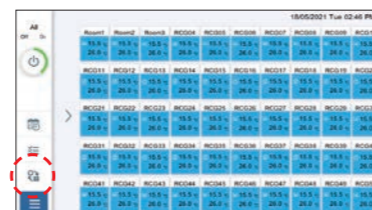

Manage & Monitor by 50 Remote Controller Groups



NEW Remote Controller Groups Rename

The remote controller group names can be changed. Users can know easily where the air conditioning is located by changing the remote controller group names.



The remote controller group name can be changed.

Features: Central Remote Controller

- Easy intuitive operation from the touch panel display.
- All functions can be accessed through the monitoring screen showing a pop-up window for detailed operation.

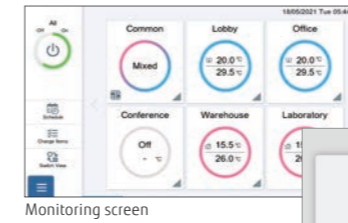

Monitoring screen

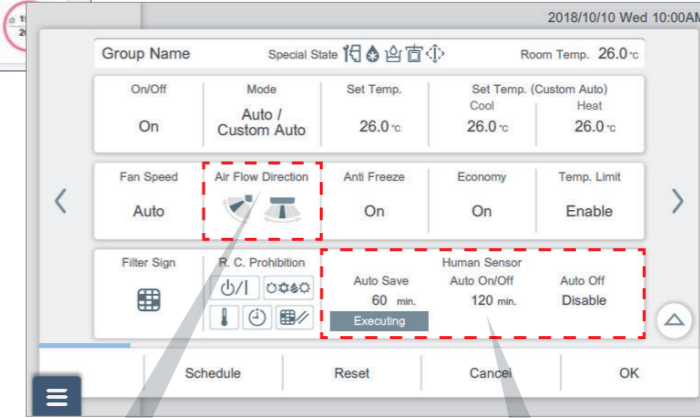

Individual setting

NEW Added individual wind direction control

Individual wind direction control has been added.
Circular Flow cassette / 3D Flow cassette



Circular flow cassette

NEW Human Sensor Compatible

Human sensor setting
• Auto save
• Auto on / off
• Auto off detection time
• Enable and disable

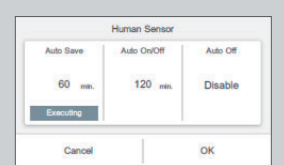

Remote Management

Remote monitoring / Remote operation

New central remote controller can control your tenant's air conditioner anytime and anywhere.

When the central remote controller manages the indoor units of some tenants, air conditioning of each tenants can be managed separately online.

NEW Increased the Number of Accounts

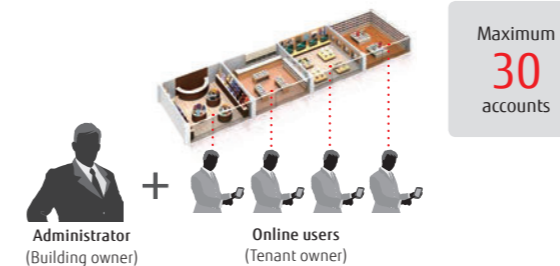

Trouble support function

Display error details

Display descriptive explanation when an error occurs



All indoor unit groups display
Display error details
- Indoor unit error
- Outdoor unit error
- Central remote controller error

Sensor value monitoring function

Monitor sensor data of indoor unit / outdoor unit, send mail

Notify room temperature by email*

Notify by e-mail when the temperature around the air conditioner is too high or too low

*:This function is available only when using wired remote controller.

Specifications

Model name	UTY-DCGYZZ
Power Supply	100-240 V 50/60 Hz
Dimensions (H × W × D) (mm)	134.6 × 216.2 × 37.9
Weight (g)	800

Touch panel controller

UTY-DTGYZ1



- Large 7.5-inch TFT color LCD screen
- Touch screen operation
- Stylish design to fit nicely into any room environment
- Controls up to 400 indoor units.
- Icon or list view can be selected in monitoring mode.
- Supports 7 languages: Chinese, English, French, German, Polish, Russian, and Spanish.
- Mounted with LAN adapter for remote control & operation, external input/output with emergency stop and batch ON/OFF

Easy operation

- Wide range of simple-to-understand icons
- Operate by pressing the icons on the screen with your finger or a stylus.
- The color on the back identifies the current control operation; blue is for monitoring and green is for operational control.

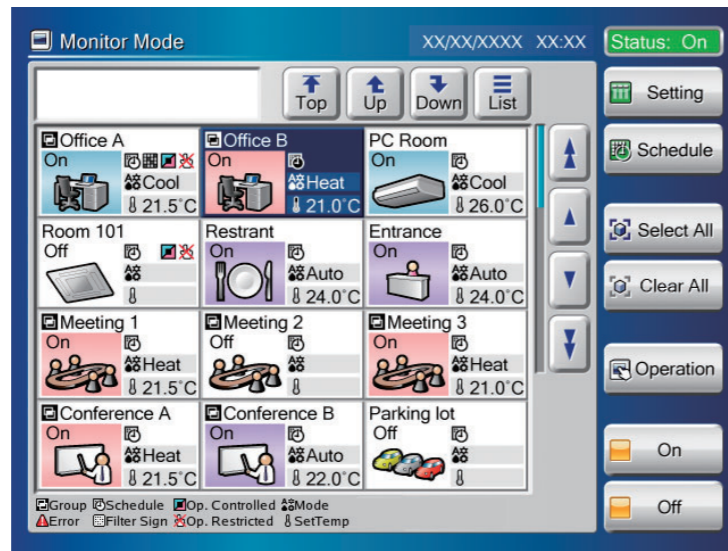

Up to 400 indoor units

Up to 100 outdoor units

Up to 400 groups

Easy maintenance

- The flat touch panel can be easily cleaned.
- Touch panel controller with non-glare coating to prevent finger marks
- Front cover for easy removal.



Easy installation

- The touch panel controller can be mounted on a wall.
- Flat back surface enables easy installation anywhere on a wall.
- No additional parts or components required for installation



Controls up to 400 indoor units.

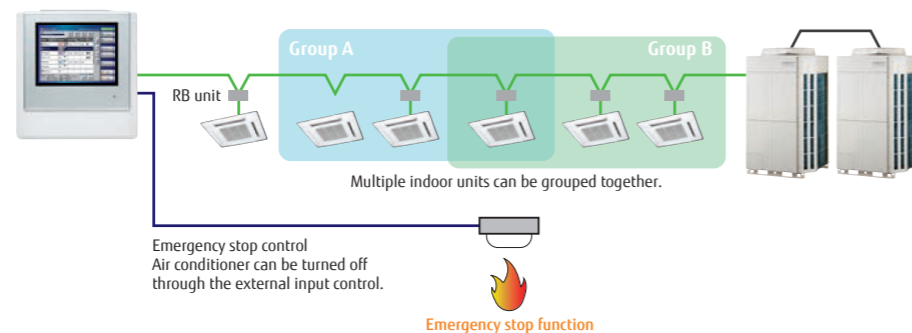

Features:

Control & monitoring

- Control and monitor Fujitsu General air conditioners via LAN or internet.
- Users and tenants can manage their assigned equipment from anywhere by computer or tablet.
- When something goes wrong, an error notice is sent by e-mail for prompt troubleshooting.

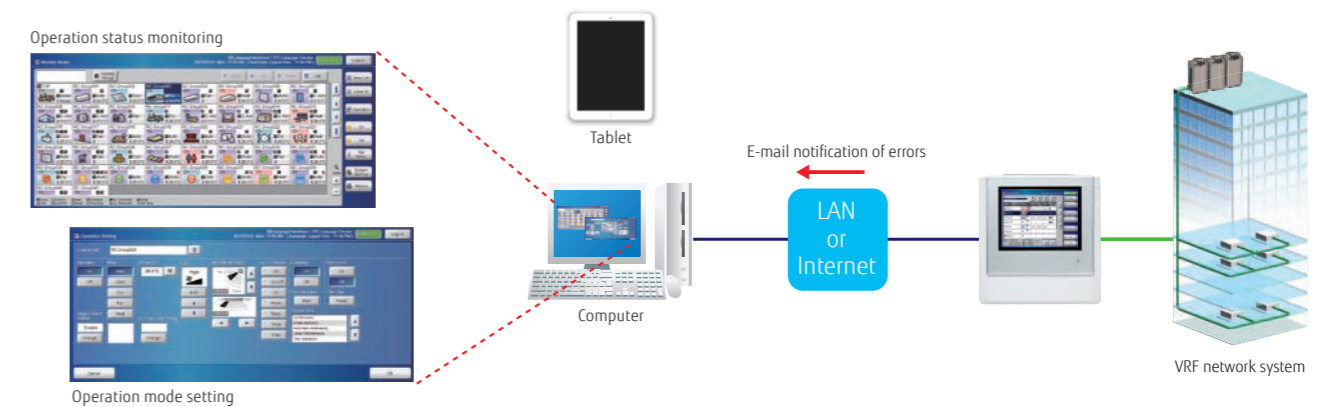

Smartphone

Model name	Browser
Nexus 6P (Android 7.1.1)	Google Chrome 5.5
iPhone 7 (iOS 10.1)	Safari 10

Tablet

Model name	Browser
iPad Pro 9.7 inch (iOS 10.2.1)	Safari 10

Flexible access permissions can be granted to users at each point level.

The administrator can register multiple users and permit them to access any indoor unit and any functions.

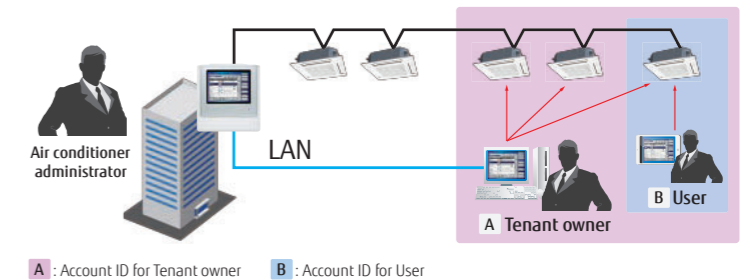

Additional languages

Supports 7 languages as standard: Chinese, English, French, German, Polish, Russian, and Spanish. Create a language database to integrate additional languages into the remote device. The added languages will only be displayed on the remote device and cannot be added to the Touch panel controller.

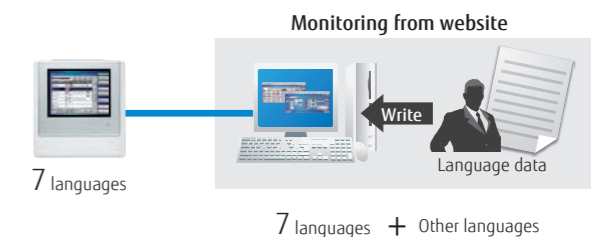

Electricity charge apportionment (Option: UTY-PTGXA)

- Energy cost can be calculated and allocated to each billing user in proportion to the amount of energy used for air conditioning.

- Apportionment charge/bill calculation
- Tenant (block) setting
- Common facilities apportionment setting
- Rated power consumption allotment setting
- Individual calculations for cooling and heating
- Electricity meter supported

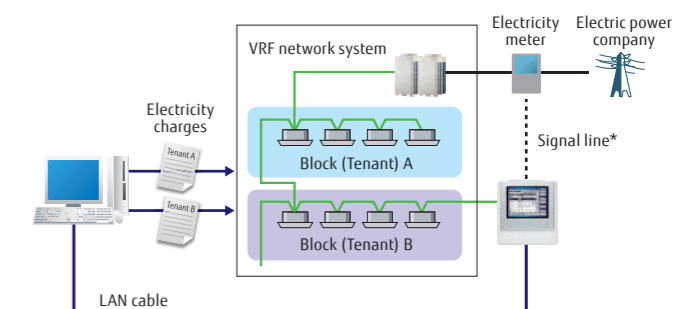

* An electricity usage meter can be connected to an external input connector of the Touch panel controller. In that case, the meter cannot be connected to an outdoor unit at the same time.

Features:

Automatic setting for daylight saving time

Functions provided

- 1) Schedule setting for daylight saving time
 - It prevents the user from forgetting to set daylight saving time. In addition, it saves time and effort for the user.

Automatic clock adjustment

- 2) Time can be set for all controllers in a batch automatically.

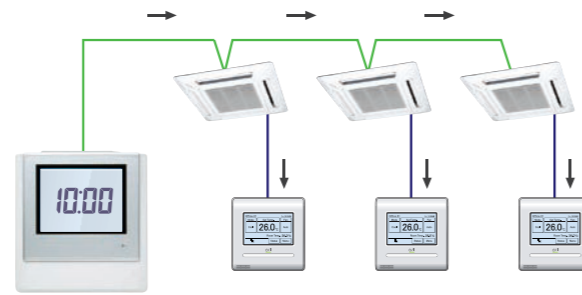

Outdoor unit low noise operation

You can choose from 4 low noise levels depending on the installation environment. ON/OFF timing of low noise mode can be set with the timer.

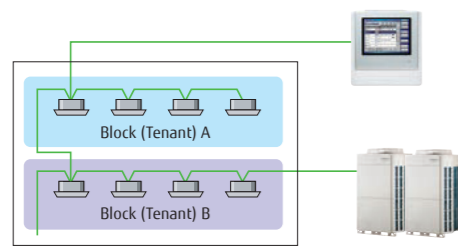

Quiet priority setting

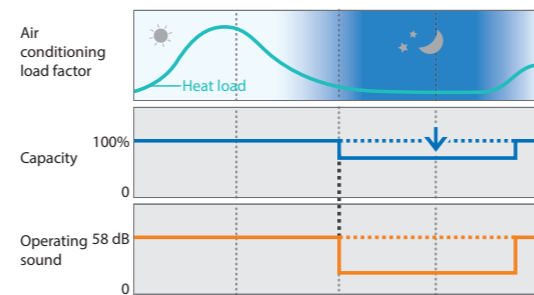

Energy-saving controls

Custom Auto

- Maintains 2 separate setpoints for heating and cooling operations.
- Automatically switches between heating and cooling modes.

* Not available for some models



Cooling set temp. 28°C, Heating set temp. 18°C

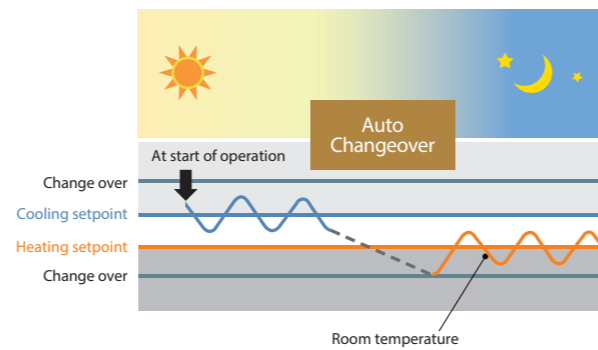

Refrigerant leak detector

Refrigerant leakage status is indicated by the management equipment. A pop-up message is displayed to notify the user, and the refrigerant is shut off.



Pop-up highlighting

FUNCTIONS SUMMARY

	UTY-DTGVZ1	Monitoring side
Air conditioning control functions		
ON/OFF	●	●
Operation mode setting*	●	●
Fan speed control	●	●
Room temperature setting	●	●
Setting temperature range limitation	●	●
Test operation	●	●
Vertical louver setting	●	●
Horizontal louver setting	●	●
Individual louver control	●*1	●
Group setting	●	●
Remote controller prohibition	●	●
Anti-freeze setting	●	●
Set temperature auto return	—	●
Energy-saving controls	—	●
Economy mode setting	●	●
Human sensor control	—	●
Displayed items		
Error	●	●
Defrosting	●	●
Current time	●	●
Day of week	●	●
Remote controller prohibition	●	●
Cooling/heating priority	●	●
Address display	●	●
Room temperature	●*3	●*3
Multiple language support	●	●
Setting for daylight saving time	●	●
Time zone setting	●	●
Name registration	●	●
Backlighting	●	●
Language setting	7	7+ other
Filter sign reset	●	●
Memory operations	●	●
Refrigerant leak detector	●	●

●: Supported ○: Optional function —: Not supported
 *1 Only setting cancellation can be operated.
 *2 Only available for external input control.
 *3 Available only when using a Wired remote controller.

	UTY-DTGVZ1	Monitoring side
Timer		
	Period	Year
Schedule timer	ON/OFF, Temp, Mode, Times per day	20
ON/OFF timer		—
Sleep timer		—
Program timer		—
Auto-off timer		●
Day off		●
Minimum unit of timer setting (minutes)	10	10
Control		
Remote monitoring management system	●	●
Electricity charge apportionment	○	○
Error history	●	●
Emergency stop	●*2	●*2
Remote monitoring management	—	●
Energy-saving management	—	—
E-mail notification in case of failure	—	●
Key lock	● Password setting	—
Low noise mode	●	●

Specifications

Model name	UTY-DTGVZ1
Power supply	Single phase ~100 to 240 V 50/60 Hz
Dimensions (H × W × D) (mm)	260 × 246 × 54
Weight (g)	2,150
Interfaces	Transmission/LAN/USB/EXT IN/EXT OUT/Reset SW

System controller

UTY-APGXZ1 **Software**

Up to **4** VRF network systems

Up to **400** outdoor units

Up to **1,600** indoor units

System controller enables advanced integrated monitoring and control of VRF network systems operating in small to large buildings.

- Up to 1,600 indoor units and 400 outdoor units on up to 4 VRF network systems can be controlled.
- To accommodate facility management needs, the system controller offers—in addition to precise air conditioning control—remote central control, electricity charge apportionment, schedule management, and energy-saving options for VRF network systems.
- Supports 7 languages: Chinese, English, French, German, Polish, Russian, and Spanish.



System controller Lite

UTY-ALGXZ1 **Software**

Up to **1** VRF network system

Up to **100** outdoor units

Up to **400** indoor units

System controller Lite offers a set of standard functions to manage air conditioners operating in a small or midsize building.

- Up to 400 indoor units and 100 outdoor units on a VRF network system can be controlled.
- In addition to precise air conditioning control, a variety of applications are available as options to offer a wider range of control.
- Supports 7 languages: Chinese, English, French, German, Polish, Russian, and Spanish.



Visually intuitive operation

Click & Operate: The visual representation of the property is shown on the screen from the perspective most suitable for operation (Click & Operate) You can select from among 4 display options: site, building, floor, and list.

Freely define groups for batched control: Indoor units can be grouped for simplified batch control from the tree menu. They can be grouped by organizational hierarchy, such as by division, department, and section.

Click & Operate the whole building! You can select from among 4 display options: site, building, floor, and list.

Click & Operate any specified unit(s)!

The display can be easily changed by pressing the button.

Batched control of freely defined groups

Batched control of freely selected units

Click & Operate the whole floor!

The floor layout drawing can be imported to easily make the settings for the actual building.

Click & Operate the unit!

Note: 2D floor layout or 3D perspective of a building is not available on System controller Lite.

Features:

Third-party devices connected via MODBUS® can be controlled.

Standard for System Controller **Option** for System controller Lite UTY-PLGXX2

When a MODBUS® adapter (locally available) is connected to a computer, electrical equipment and devices supported by MODBUS® can be monitored and controlled centrally from the computer. The central control can reduce wasted energy throughout an entire building resulting from a failure to turn equipment off during or after work, as well as reduce the need for on-site patrols.

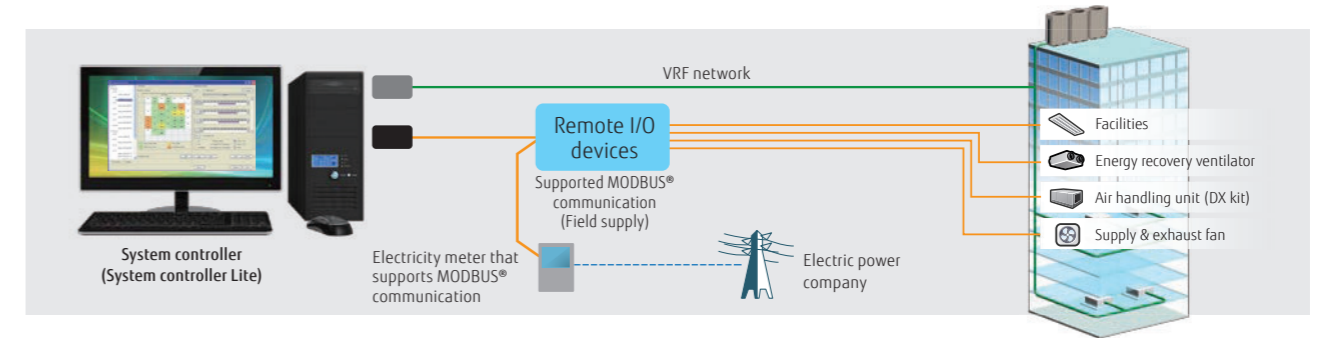

Wide-ranging operation and data management

Standard System controller and System controller Lite

Schedule management

- An annual schedule can be arranged for each remote controller group or user-defined group.
- ON/OFF, operation mode, remote controller prohibition, and temperature settings can be programmed for up to 143 times per day at 10-minute intervals and for up to 101 configurations for each remote controller group.
- Settings can be programmed for a period that spans midnight.
- Allows for the programming of special settings for weekends, holidays, and store closings throughout the year.
- Low noise operation of outdoor units can be scheduled.

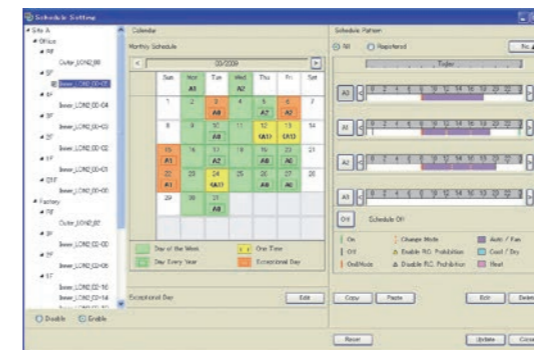

Wide-ranging control of indoor and outdoor units

- The operation status and mode of each indoor unit are displayed.
- Turn on and off each indoor unit and switch its operation mode.
- Setting temperature range limitation
- Low noise setting of outdoor units

Remote controller prohibition

Prohibits the operation mode, temperature setting, or ON/OFF of an indoor unit.

Error alert and e-mail notice

When something goes wrong, an error message is shown in a popup on a computer display with a chime, and an e-mail notice is sent. Errors of the past one year are logged and can be reviewed.

Operation and control history

A history of operation status and control can be maintained and retrieved.

Importing and exporting databases

Only an administrator is authorized to import and export registration, layout, and image data.

Automatic clock adjustment

Time can be set for all controllers in batch automatically.

Electricity charge apportionment

Standard on System controller
Option System controller Lite UTY-PLGXA2

Electricity charge apportionment method

This is a method to calculate monthly energy costs to be allocated to each tenant based on the amount of energy used by their air conditioners. The first step is to determine exactly how much energy is consumed by air conditioners in each tenant space. The second step is to divide the total energy charge billed by an electric power company based on the amount of energy used by each tenant to determine the energy cost to be allocated to each of them. (See figure on right) The calculation takes into consideration such factors as the number of unused rooms and nighttime electricity rate, which are shown in detail on an energy cost allocation schedule.

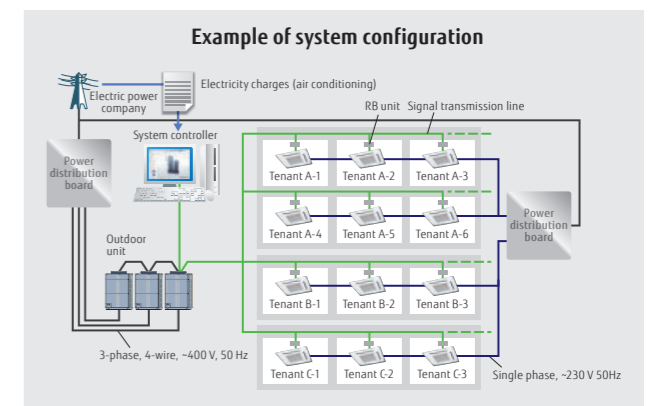

Features:

Remote monitoring management

- Standard** on System controller
- Option** System controller Lite UTY-PLGXR2

The System controller can be used on site or remotely over networks for remote central control. The System controller requires 2 software programs working together: The VRF controller runs on site and communicates with the VRF system; The VRF explorer, which runs at a remote location, provides a user interface and communicates with the VRF controller. The VRF controller and the VRF explorer run on a single computer or on different computers connected on a network. A computer running VRF explorer can centrally control up to 10 VRF system sites having up to 20 buildings each.

On site central control

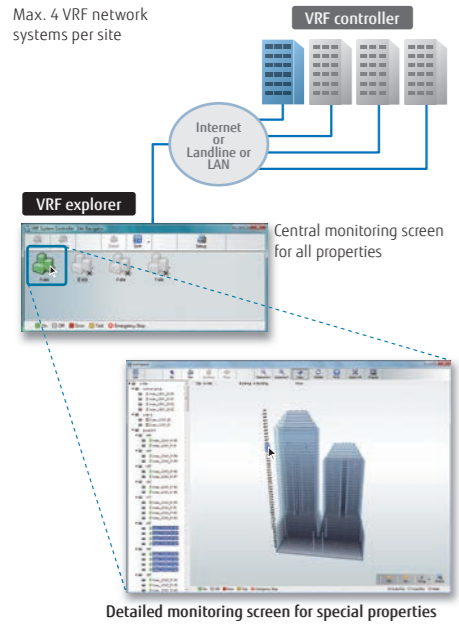

Remote central control

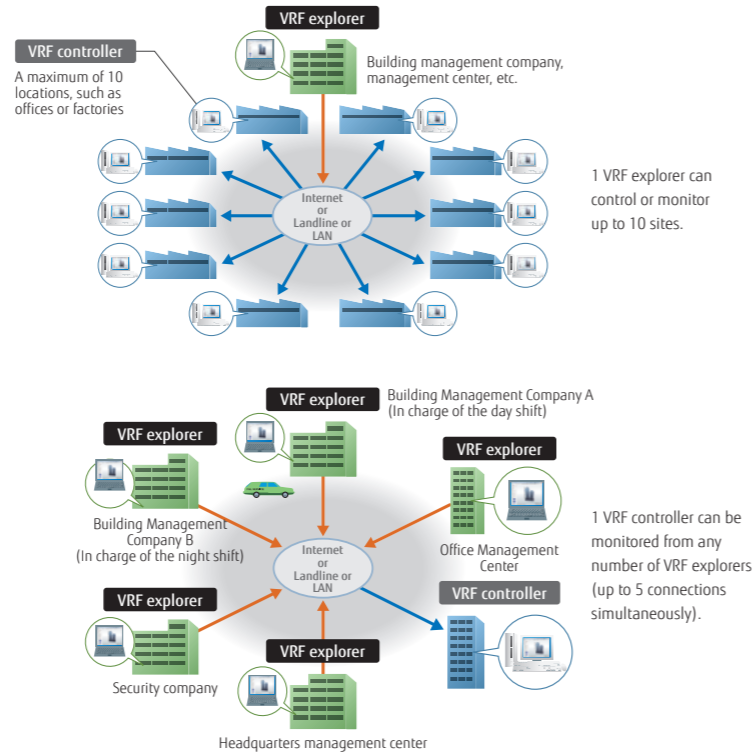

Energy-saving management

- Option** System controller UTY-PEGXZ1
- Option** System controller Lite UTY-PLGXE2

A variety of energy-saving options can be selected depending on the season, weather, and time of day. Excellent energy-saving operation is performed while keeping users comfortable.



Main screen for energy-saving management

Energy saving graph data: This chart compares the energy consumption for the current month with the previous month and with the same month of the previous year to keep track of the energy-saving performance.

Indoor unit rotation

Indoor units can be automatically rotated to operate within a group in accordance with a predetermined annual schedule to reduce power consumption while keeping users comfortable. The operation stoppage rate can be selected for an indoor unit.

Peak-cut mode

The system controller monitors the connected power meter and controls the energy to maintain the target power consumption set for each time period by changing the set temperature of the indoor units or turning off the thermostat so as to keep the users comfortable. Indoor units to be controlled can be grouped in many ways, and the control level can be set for each group.

Capacity saving for outdoor unit

The upper limit on the capacity of an outdoor unit can be adjusted to reduce power consumption during a hot summer or cold winter by averaging out the power-saving performance of each refrigerant system. The upper limit on capacity can be set at 50% of the rated capacity or more.

Summary of functions

Functions	Type	System controller		System controller Lite				
		UTY-APGXZ1	Option UTY-PEGXZ1	UTY-ALGXZ1	Option UTY-PLGXR2	Option UTY-PLGXA2	Option UTY-PLGXE2	Option UTY-PLGXX2
Specifications	Max. number of VRF networks supported	4	—	1	—	—	—	—
	Max. number of indoor unit and remote controller groups per VRF network	400	—	400	—	—	—	—
	Max. number of outdoor units per VRF network	100	—	100	—	—	—	—
	Max. number of indoor units and remote controller groups per System controller	1600	—	400	—	—	—	—
Site supervision	Multiple site display	10	—	10	—	—	—	—
	Number of buildings per site	20	—	—	—	—	—	—
	Number of floors per site	200	—	—	—	—	—	—
	Number of floors per building	50	—	—	—	—	—	—
	3D graphical layout view	●	—	—	—	—	—	—
	2D graphical layout view	●	—	—	—	—	—	—
Error management	List display	●	—	●	—	—	—	—
	Tree display	●	—	●	—	—	—	—
	Group display	●	—	●	—	—	—	—
History	Error notification	●	—	●	—	—	—	—
	Audible alarm	●	—	●	—	—	—	—
	E-mail notification of errors	●	—	●	—	—	—	—
Operation control	Individual control	●	—	●	—	—	—	—
	ON/OFF	●	—	●	—	—	—	—
	Operation mode*	●	—	●	—	—	—	—
	Room temperature	●	—	●	—	—	—	—
	Fan speed	●	—	●	—	—	—	—
	Airflow direction	●	—	●	—	—	—	—
	Economy mode	●	—	●	—	—	—	—
	Setting temperature range limitation	●	—	●	—	—	—	—
	Anti-freeze	●	—	●	—	—	—	—
	Low noise setting of outdoor units	●	—	●	—	—	—	—
	Individual management	●	—	●	—	—	—	—
	Remote controller prohibition	●	—	●	—	—	—	—
Setting temperature range limitation	●	—	●	—	—	—	—	
Filter sign reset	●	—	●	—	—	—	—	
Other	●	—	●	—	—	—	—	
memory operations	●	—	●	—	—	—	—	
Pattern operations	●	—	●	—	—	—	—	
Schedule	Annual Schedule	●	—	●	—	—	—	—
	Setting for a specific date	●	—	●	—	—	—	—
	ON/OFF per day	72	—	72	—	—	—	—
	ON/OFF per week	504	—	504	—	—	—	—
	Day off	●	—	●	—	—	—	—
	Minimum unit of timer setting (minutes)	10	—	10	—	—	—	—
Remote monitoring management	Weekly schedule for low noise mode	●	—	●	—	—	—	—
	Web Operation	●	—	●	—	—	—	—
	Remote monitoring	●	—	●	—	—	—	—
Electricity charge apportionment	Remote operation control	●	—	●	—	—	—	—
	Remote function setting	●	—	●	—	—	—	—
	Apportionment charge/bill calculation	●	—	●	—	—	—	—
	Tenant (block) setting	●	—	●	—	—	—	—
Energy-saving management	Common facilities apportionment setting	●	—	●	—	—	—	—
	Rated power consumption allotment setting	●	—	●	—	—	—	—
	Individual calculations for cooling and heating	●	—	●	—	—	—	—
	Electricity meter supported	●	—	●	—	—	—	—
Control of external devices	Indoor unit rotation	●	—	●	—	—	—	—
	Peak cut control	●	—	●	—	—	—	—
	Capacity saving for outdoor unit	●	—	●	—	—	—	—
	Record of energy-saving operation	●	—	●	—	—	—	—
Others	Information on energy saving	●	—	●	—	—	—	—
	Power consumption monitor	●	—	●	—	—	—	—
	Electricity meter supported	●	—	●	—	—	—	—
	Monitor	●	—	●	—	—	—	—
Control	Importing and exporting databases	●	—	●	—	—	—	—
	Automatic clock adjustment	●	—	●	—	—	—	—
	Multiple language support	7 languages	—	7 languages	—	—	—	—
	Refrigerant leak detector	●	—	●	—	—	—	—
Power shutdown	●	—	●	—	—	—	—	

●: Available - : Not available

Computer requirements

The specifications required for the computer are shown in the table below:

	System controller	System controller Lite
Operating system	<ul style="list-style-type: none"> Microsoft® Windows® 7 Home Premium (32-bit or 64-bit) SP1, Windows® 7 Professional (32-bit or 64-bit) SP1 Microsoft® Windows® 8.1 (32-bit or 64-bit), Windows® 8.1 Pro (32-bit or 64-bit) Microsoft® Windows® 10 Home (32-bit or 64-bit), Windows® 10 Pro (32-bit or 64-bit) Supports 7 languages: English, Chinese, French, German, Russian, Spanish, and Polish	<ul style="list-style-type: none"> Microsoft® Windows® 7 Home Premium (32-bit or 64-bit) SP1, Windows® 7 Professional (32-bit or 64-bit) SP1 Microsoft® Windows® 8.1 (32-bit or 64-bit), Windows® 8.1 Pro (32-bit or 64-bit) Microsoft® Windows® 10 Home (32-bit or 64-bit), Windows® 10 Pro (32-bit or 64-bit) Supports 7 languages: English, Chinese, French, German, Russian, Spanish, and Polish
CPU	Intel® Core™ i3 2 GHz or higher	Intel® Core™ i3 2 GHz or higher
Memory	<ul style="list-style-type: none"> 2 GB or more (for Windows® 7 [32-bit]) 4 GB or more (for Windows® 7 [64-bit], Windows® 8.1, and Windows® 10) 	<ul style="list-style-type: none"> 2 GB or more (for Windows® 7 [32-bit]) 4 GB or more (for Windows® 7 [64-bit], Windows® 8.1, and Windows® 10)
HDD	40 GB or more of free space	40 GB or more of free space
Displayed items	1024 × 768 or higher resolution	1024 × 768 or higher resolution
Interfaces	<ul style="list-style-type: none"> Ethernet port (for getting access to the internet using LAN) or a modem (for getting access to the internet via landline) Up to 6 USB ports (Only required for a server computer working as a VRF controller) - Maximum of 2 USB ports are required to connect to a White-USB-key/WibuKey - Up to 4 USB ports required to connect to an Echelon® U10 USB network interface * Maximum number of required USB ports depends on the applicable system configuration. 	<ul style="list-style-type: none"> Ethernet port (for getting access to the internet using LAN) or a modem (for getting access to the internet via landline) Up to 6 USB ports (Only required for a server computer working as a VRF controller) - Maximum of 4 USB ports are required to connect to a White-USB-key/WibuKey - 1 USB port is required for an Echelon® U10 USB Network interface * The maximum number of required USB ports depends on the applicable system configuration.
Graphic accelerator	Microsoft® DirectX® 9.0c compatible	Microsoft® DirectX® 9.0c compatible
Software	Adobe® Acrobat Reader® 9.0 or later	Adobe® Acrobat Reader® 9.0 or later

* Echelon® U10 USB Network interface - TP/FT-10 Channel (Model name: 75010R) (Required for each VRF Network)

Packing list

Type	For System controller			For System controller Lite			
	System controller	Option Energy manager	System controller Lite	Remote access	Option Electricity charge apportionment	Option Energy saving	Option Centralized control
Model name	UTY-APGXZ1	UTY-PEGXZ1	UTY-ALGXZ1	UTY-PLGXR2	UTY-PLGXA2	UTY-PLGXE2	UTY-PLGXX2
White-USB-key	1	1	1	1	1	1	1

*1: Software protection key to be inserted in a USB slot running System controller or System controller Lite. System controller or System controller Lite may only run on a PC with a WHITE-USB-KEY. However, a WHITE-USB-KEY is not required for remote VRF explorer software.

BACnet® gateway

UTY-ABGXZ1 (Software)



White-USB-key
(Software Protection Key)



BACnet® is a registered trademark of ASHRAE. ASHRAE does not endorse, approve or test products for compliance with ASHRAE standards. Compliance of listed products to the requirements of ASHRAE Standard 135 is the responsibility of BACnet International (BI). BTL is a registered trademark of BACnet International.

Up to
4
VRF network systems

Up to
400
outdoor units

Up to
1,600
indoor units

- A medium to large BMS can be connected to a VRF network system via BACnet®, a standard communication protocol for open networks.
- Up to 1,600 indoor units on up to 4 VRF network systems (up to 400 indoor units and 100 outdoor units per system) can be connected to a single BACnet® gateway.
- The VRF network system can be controlled or monitored from BMS via BACnet® gateway.
- Compatible with BACnet® (ANSI/ASHRAE-135-2014) application specific controller (B-ASC).
- Compatible with BACnet®/IP over Ethernet.
- Scheduling, alarm and event setting, and energy cost allocation are provided on the BACnet® gateway.
- The VRF network system can be connected to a computer via a U10 USB interface. Note that Fujitsu General does not supply a U10 USB interface or a computer. They must be purchased separately by the user.
- Corresponds to 7 different languages: English, Chinese, French, German, Spanish, Russian, Polish.

Installation example

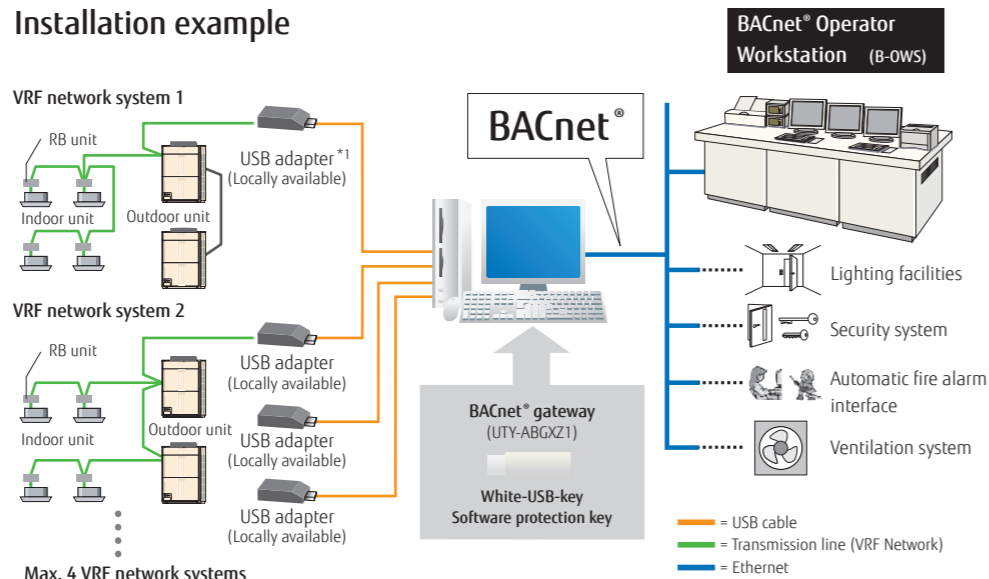

*1: U10 USB network interface available from Echelon® Corporation.

Computer requirements

	UTY-ABGXZ1
Operating system	<ul style="list-style-type: none"> • Microsoft® Windows® 7 Home Premium (32-bit or 64-bit) SP1, Windows® 7 Professional (32-bit or 64-bit) SP1 • Microsoft® Windows® 8.1 (32-bit or 64-bit), Windows® 8.1 Pro (32-bit or 64-bit) • Microsoft® Windows® 10 Home (32-bit or 64-bit), Windows® 10 Pro (32-bit or 64-bit) Supported languages: Chinese, English, French, German, Polish, Russian, and Spanish
CPU	Intel® Core™ i3 2 GHz or higher
Memory	<ul style="list-style-type: none"> • 2 GB or more (for Windows® 7 [32-bit]) • 4 GB or more (for Windows® 7 [64-bit], Windows® 8.1, and Windows® 10)
HDD	40 GB or more of free space
Displayed items	1024 × 768 or higher resolution
Interfaces	<ul style="list-style-type: none"> • Ethernet port (for getting access to the internet using LAN) • Up to 5 USB ports - 1 USB port required to connect to a White-USB-key/WibuKey - Up to 4 USB ports required to connect to an Echelon® U10 USB network interface *The maximum number of required USB ports varies depending on the applicable system configuration.
Software	Adobe® Acrobat Reader® 9.0 or later

• Echelon® U10 USB Network interface – TP/FT-10 Channel (Model name: 75010R) (Required for each VRF Network)

Packing list

Name and shape	Quantity	Application
White-USB-key	1	Includes the software, user's manual, and license for BACnet® gateway.

BACnet® gateway

UTY-VBGX (Hardware)



BACnet® is a registered trademark of ASHRAE. ASHRAE does not endorse, approve or test products for compliance with ASHRAE standards. Compliance of listed products to the requirements of ASHRAE Standard 135 is the responsibility of BACnet International (BI). BTL is a registered trademark of BACnet International.

Up to
1
VRF network system

Up to
32
refrigerant systems

Up to
128
indoor units

Installation example

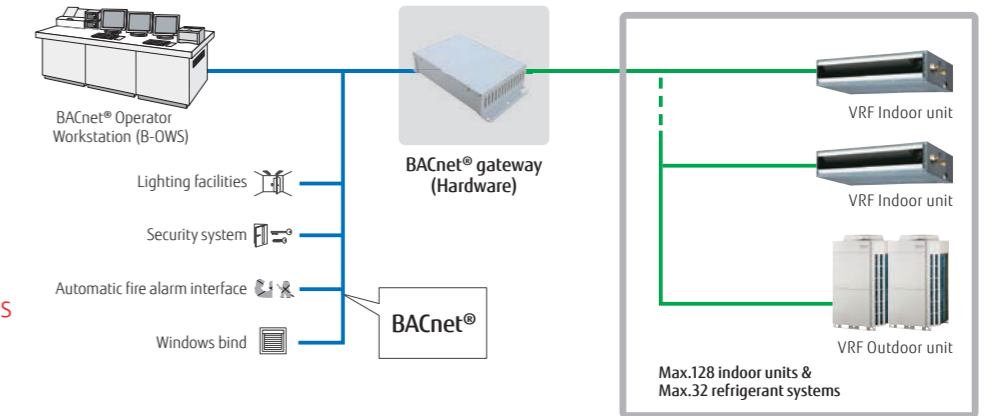

Specifications

Model name	UTY-VBGX
Number of controllable indoor units	128
Number of controllable refrigerant systems	32
Number of controllable VRF networks	1
Number of connectable units / one VRF network	4

Model name	UTY-VBGX
Power supply	Single phase, 100-240 V, 50/60 Hz
Power consumption (W)	4.6 (max.)
Dimensions (H × W × D) (mm)	59.6 × 270.4 × 176
Weight (g)	1200

Multiple protocol LAN adapter

FG-TL-MBS16Z1



NEW



FG-TL-MBS16Z1
(VRF type)

No separate external power supply required

- Can be used for 16 indoor units.

Installation example

[VRF type]

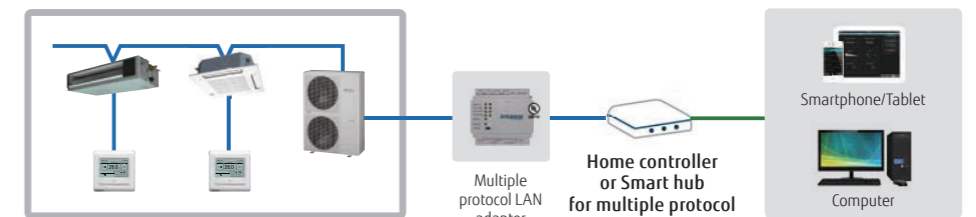

Up to
16
indoor units

Specifications

Model name	FG-TL-MBS16Z1 (VRF type)
Power supply	9 to 36 V DC, Max.: 140 mA or 24 V AC 50/60 Hz, Max.: 127 mA.*
Input power (W)	1.7
Dimensions (H × W × D) (mm)	90 × 88 × 56
Weight (g)	330

*24 V DC power supply is recommended.

BACnet®/MODBUS® Router

FG-RTR-BAC32Z1/FG-RTR-MBS32Z1



NEW



FG-RTR-BAC32Z1 (BAC net)

NEW



FG-RTR-MBS32Z1 (MODBUS®)

Routing between BaCnet® MS/TP and BaCnet® IP networks

- Routing between BaCnet® MS/TP and BaCnet® IP networks
- Routing between MODBUS® RTU and MODBUS® TCP networks

Installation example

[BaCnet® type]

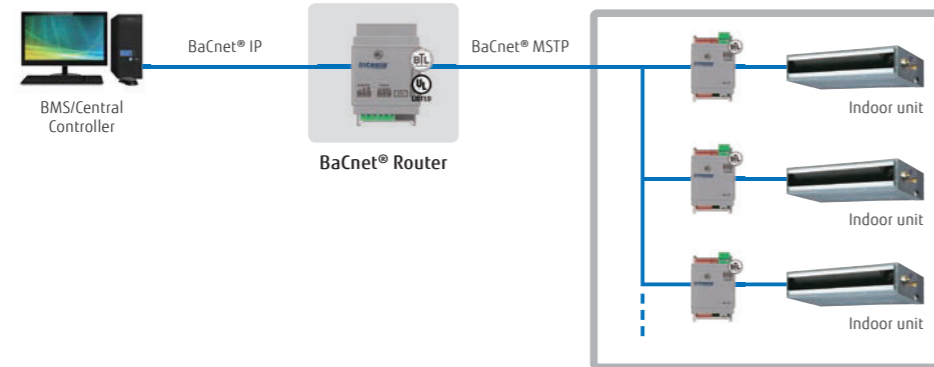

[MODBUS® type]

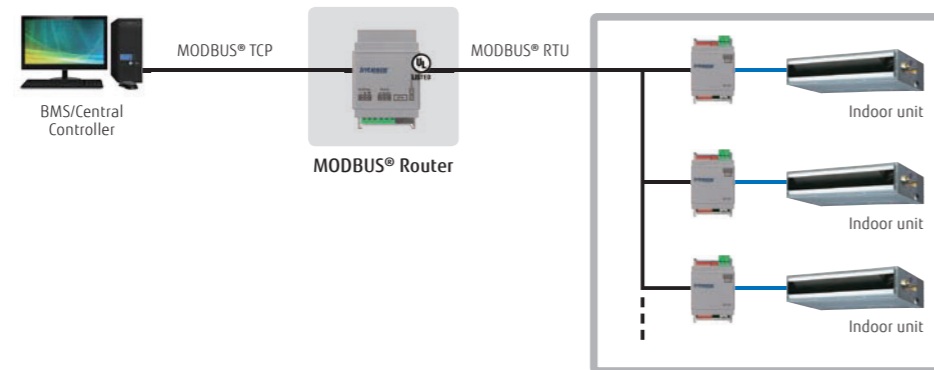

Specifications

Model name	FG-RTR-BAC32Z1 (MS/TP to IP)	FG-RTR-MBS32Z1 (RTU to TCP)
Number of routable devices (max.)	32	32
Power supply	9 to 36 V DC, Max.: 140 mA or 24 V AC 50/60 Hz, Max.: 127 mA	9 to 36 V DC, Max.: 140 mA or 24 V AC 50/60 Hz, Max.: 127 mA
Power consumption (W)	1.7	1.7
Dimensions (H × W × D) (mm)	93 × 53 × 58	93 × 53 × 58
Weight (g)	150	150

BACnet®/MODBUS® Cloud Device

FG-CLD-BMG4Z1/FG-CLD-BMG8Z1/FG-CLD-BMG16Z1/FG-CLD-BMG32Z1



NEW



FG-CLD-BMG4/8/16/32Z1

- The most powerful configuration tool common to all BACnet® gateways provides the system integrators with the power to configure and monitor their systems in an easy and reliable manner.
- A simple, easy-to-use description for the ST Cloud Web and App User Interface, with all widgets customizable to the user's needs, enabling system integrators to easily offer the best user experience to customers who are in control of their BaCnet® or MODBUS® devices.

Installation example

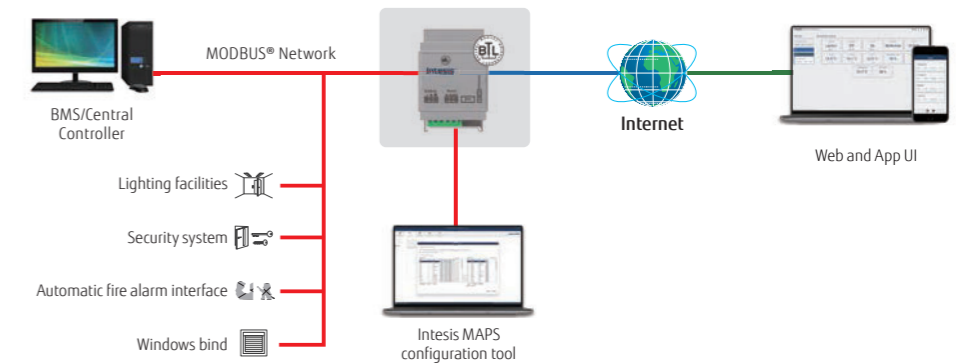

*BMS: Building Management System

Gateway features

- BaCnet® IP/MSTP or MODBUS® TCP/RTU connectivity
- Up to 32 devices can be connected to each gateway.
- Up to 12 widgets per device
- Easy device configuration with Intesis MAPS

Next-generation services

- Industrial-grade connectivity now for building automation
- Fast and scalable real-time edge connectivity over HMS HubTM
- Full data control and protection
- Secure and remote updates during the application lifetime

System Features

- Monitor and control all devices in an intuitive way
- Comes with a native iOS and Android app and a web interface
- Create scenes and interact with multiple concurrent devices
- Calendar that shows the daily planned installation commands
- Notifications keep you updated about system status
- Device sharing and usage permissions management
- Multiple site management from a common dashboard

Specifications

Model name	FG-CLD-BMG4Z1	FG-CLD-BMG8Z1	FG-CLD-BMG16Z1	FG-CLD-BMG32Z1
Number of connectable BaCnet® (IP/MSTP) or MODBUS® (TCP/RTU) devices	4	8	16	32
Power supply	9 to 24 V DC, 50/60Hz	9 to 24 V DC, 50/60Hz	9 to 24 V DC, 50/60Hz	9 to 24 V DC, 50/60Hz
Power consumption (W)	1.7	1.7	1.7	1.7
Dimensions (H × W × D) (mm)	93 × 53 × 58	93 × 53 × 58	93 × 53 × 58	93 × 53 × 58
Weight (g)	150	150	150	150

MODBUS® convertor for VRF

UTY-VMGX/FG-TL-MBS16Z1



UTY-VMGX

MODBUS® convertor enables air conditioners to be fully integrated into a MODBUS® network.

- Compact and lightweight design
- Direct connection to MODBUS® network
- MODBUS® convertor enables central monitoring and control of air conditioners from BMS or a central controller.
- Up to 9 converters can be connected to a VRF network (UTY-VMGX). Simultaneous control, such as Power ON/ OFF and temperature setting, can be performed for each zone.
- If a connection error occurs after installation work is completed, the source of the error can be located easily.

Up to 9 units per VRF system

Up to 100 outdoor units

Up to 128 indoor units

NEW



FG-TL-MBS16Z1

Up to 16 indoor units

Up to 16 outdoor units

Installation example

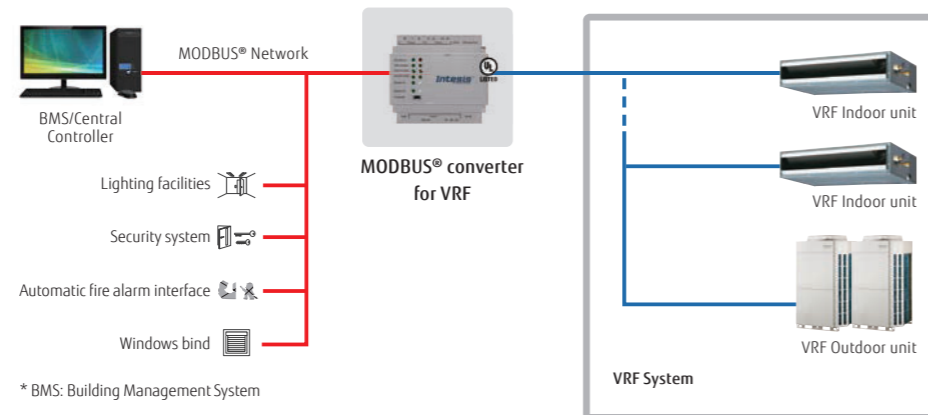
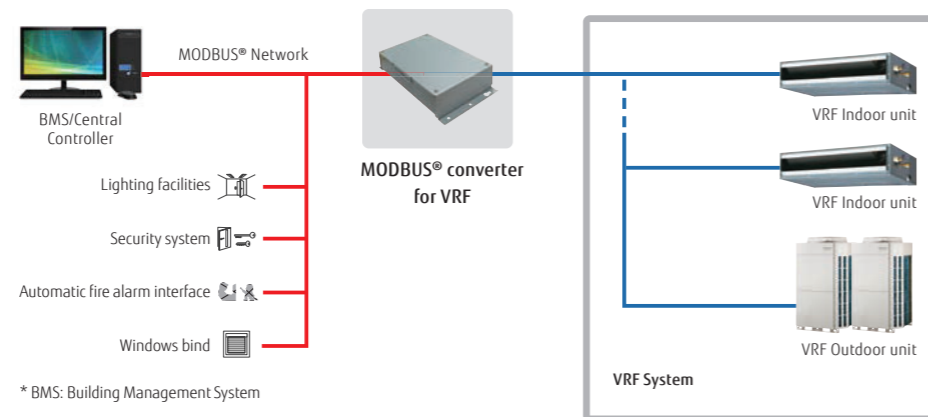

Specifications

Model name	UTY-VMGX	FG-TL-MBS16Z1
Power supply	Single phase ~220 to 240 V 50/60 Hz	9 to 36 V DC, Max.: 140 mA or 24 V AC 50/60 Hz, Max.: 127 mA.*
Input power (W)	Max. 2	1.7
Dimensions (H × W × D) (mm)	54 × 260 × 150	90 × 88 × 56
Weight (g)	1,100	330

*24 V DC power supply is recommended.

KNX® converter for VRF

UTY-VKGX/FG-TL-KNX16Z1

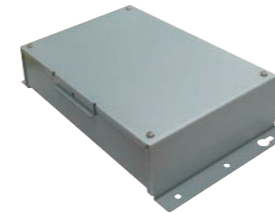

UTY-VKGX

KNX® converter enables centralized control of a system.

- KNX® converter connects a central or home controller and a Fujitsu General VRF system.
- Up to 128 indoor units and 100 outdoor units can be connected to a single KNX® converter. (UTY-VKGX)

Up to 100 outdoor units

Up to 128 indoor units

NEW



FG-TL-KNX16Z1

Up to 16 indoor units

Up to 16 outdoor units

Installation example

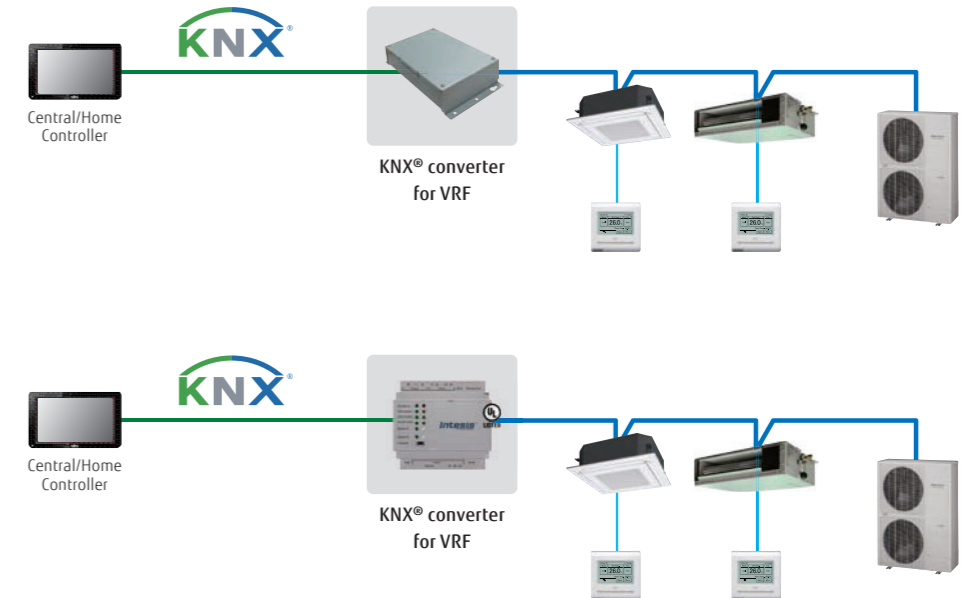

Specifications

Model name	UTY-VKGX	FG-TL-KNX16Z1
Power supply	Single phase ~220 to 240 V 50/60 Hz	9 to 36 V DC, Max.: 140 mA or 24 V AC 50/60 Hz, Max.: 127 mA.*
Input power (W)	1.5	1.6
Dimensions (H × W × D) (mm)	54 × 260 × 150	90 × 88 × 56
Weight (g)	1,200	340

*24 V DC power supply is recommended.

Signal amplifier

UTY-VSGXZ1

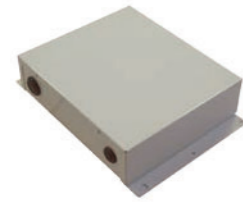

- The transmission line can be extended up to 3,600 m using multiple Signal amplifiers.
- Up to 8 Signal amplifiers can be added in a VRF network system.
- A Signal amplifier is required.
 - (1) When the total wiring length of the transmission line exceeds 500 m.
 - (2) When the total number of units on the transmission line exceeds 64.

Installation example

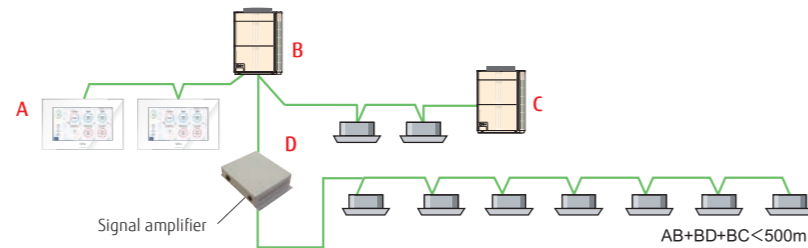

Specifications

Model name	UTY-VSGXZ1
Power supply	Single phase ~208 to 240 V 50/60 Hz
Power consumption (W)	4.5
Dimensions (H × W × D) (mm)	67 × 288 × 211
Weight (g)	1,500

Network converter for LONWORKS®

UTY-VLGX

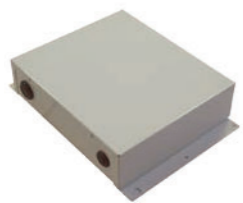

- Connects the VRF network system to a **LONWORKS®** open network to manage small and midsized BMS and VRF network system.
- The UTY-VLGX enables centralized monitoring and control of VRF network system from a BMS via a **LONWORKS®** interface.
- Up to 128 Indoor units can be connected to one network converter for **LONWORKS®**

Installation example

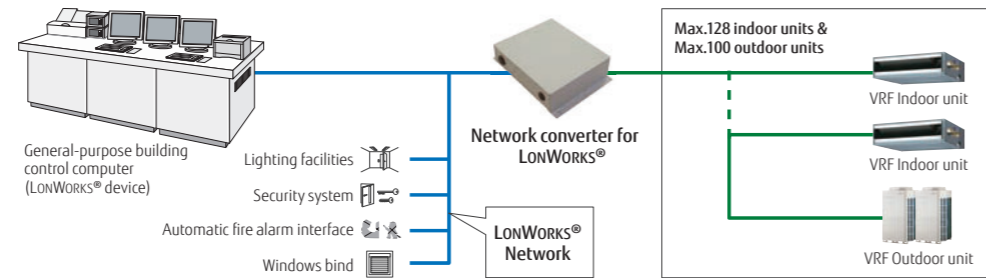

- Up to 4 units to BMS
- Up to 100 outdoor units
- Up to 128 indoor units

Specifications

Model name	UTY-VLGX
Power supply	Single phase ~208 to 240 V 50/60 Hz
Power consumption (W)	4.5
Dimensions (H × W × D) (mm)	67 × 288 × 211
Weight (g)	1,500

Transmission specifications (BMS side)

Transmission speed	78 kbps
Transceiver	FT-X1 (available from Echelon® Corporation)
Transmission line form	Free topology
Terminal resistor	None (converter to be attached at the terminal of a network)



Controller system list (available) for Split/Multi-split

Controller Options/Accessories:



Type	Refrigerant	Indoor unit																		Outdoor unit				
		Wall-mounted						Cassette		Duct		Duct						Multi-split				Single phase		
		Flagship Series	Designer Series		Standard Series		ECO Series	Compact 4-way flow Series	Circular flow Series	Slim	Medium static pressure (Compact)	Medium static pressure (Standard)	High static pressure		BIG	Floor	Ceiling	Wall-mounted	Compact cassette		Mini duct		Slim duct	
ASYG 12KXCA	ASYG 07/09/12/14 KGTB	ASYG 07/09/12/14 KETA, KETA-B	ASYG 07/09/12/14 KMCC	ASYG 18/24KMTB	ASYG 30/36KMTA	ASYG 07/09/12 KPCA	AUXG 09/12/14/18/22/24 KVLA	AUXG 18/22/24/30/36/45/54 KRLB	ARXG 09/12/14/18 KLLAP	ARXG 12/14/18/22/24/30/36/45/54 KHTAP	ARXG22KMLB, ARXG 24/30/36/45 KMLA	ARXG 45/54KHTA	ARYG 45/54/60 LHTA	ARYG 72/90LHTA	ACYG 09/12/14 KVCA	ABYG 18/22/24/30/36/45/54 KR1A	ASYG 22KMTB	AUXG 07KVLA	ARXG 07/09/12/14/18 KSLAP	ARXG 07KLLAP	AOYG36KBTAS			
Wired remote controller			● UTY-RNRYZ5+ UTY-TWRXZ2		● UTY-RNRYZ5+ UTY-TWRXZ2			● UTY-RNRYZ5			● UTY-RNRYZ5				● UTY-RNRYZ5	● UTY-RNRYZ5+ UTY-TWRXZ3	● UTY-RNRYZ5	● UTY-RNRYZ5+ UTY-TWRXZ2		● UTY-RNRYZ5				
			● UTY-RLRY+ UTY-TWRXZ2		● UTY-RLRY+ UTY-TWRXZ2			● UTY-RLRY			● UTY-RLRY				● UTY-RLRY	● UTY-RLRY+ UTY-TWRXZ3	● UTY-RLRY	● UTY-RLRY+ UTY-TWRXZ2		● UTY-RLRY				
			● UTY-RCRYZ1+ UTY-TWRXZ2		● UTY-RCRYZ1+ UTY-TWRXZ2			● UTY-RCRYZ1			● UTY-RCRYZ1				● UTY-RCRYZ1	● UTY-RCRYZ1+ UTY-TWRXZ3	● UTY-RCRYZ1	● UTY-RCRYZ1+ UTY-TWRXZ2		● UTY-RCRYZ1				
					● UTY-RVNYM+ UTY-TWBXFZ			● UTY-RVNYM			● UTY-RVNYM										● UTY-RVNYM			
					● UTY-RNNYM+ UTY-TWBXFZ			● UTY-RNNYM			● UTY-RNNYM										● UTY-RNNYM			
Simple remote controller			● UTY-RSRY UTY-RHRY+ UTY-TWRXZ2		● UTY-RSRY UTY-RHRY+ UTY-TWRXZ2			● UTY-RSRY, UTY-RHRY, UTY-RSNYM			● UTY-RSRY, UTY-RHRY, UTY-RSNYM				● UTY-RSNYM	● UTY-RSRY UTY-RHRY UTY-RSNYM	● UTY-RSRY UTY-RHRY	● UTY-RSRY UTY-RHRY+ UTY-TWRXZ3	● UTY-RSRY UTY-RHRY	● UTY-RSRY UTY-RHRY+ UTY-TWRXZ2		● UTY-RSRY UTY-RHRY UTY-RSNYM		
Central remote controller																						● UTY-DMMYM1*3 (KBTAS) ● UTY-DMMYM*3 (LBLA6, LBT8)		
Wireless remote controller							● UTY-LNTY														● UTY-LNTY			
IR receiver unit with Wireless remote controller															● UTY-LRHYM (60)	● UTY-LRHYM								
								● UTY-LBTYC	● UTY-LBTYM		● UTY-LBTYM					● UTY-LBTYM		● UTY-LBTYH				● UTY-LBTYM	● UTY-LBTYM	

*1: Available only when the WLAN adapter (UY-TFSXF2) is removed. *2 Available only when the WLAN adapter (UY-TFSXZ1) is removed. *3 Consult your dealer for conditions of use.

Controller System List (available) for VRF

Controller Options:



Type	Refrigerant	Indoor unit																										
		Cassette						Duct						Indoor unit														
		One-way flow	3D flow	Compact Grid type/ Standard type	Slim type		Large type		Low static pressure duct			Medium static pressure			Duct			Floor		Ceiling/ Floor	Ceiling	Wall-mounted						
					4-way flow		Circular flow		Mini (With drain pump)	Slim (With drain pump)		Slim High-efficiency		High efficiency		Normal	High efficiency		-			External EEV	-	External EEV	-	-		
AUXV 004/007/009/ 012/014/018/ 024GLEH	AUXS 018/024 GLEH	AUXB 004/007/009/ 012/014/018/ 024GLEH	AUXD 18/24GALH	AUXA 18/24/30/ 34/36/45/54 GALH	AUXN 009/012/014 GLAH, AUXM 018/024/030 GLEH	AUXK 018/024/030/ 034/036/045/ 054GLEH	ARXK 004/007/009/ 012/014/018/ 024GLGH	ARXD 04GALH	ARXD 007/009/012/ 014/018/024 GLEH	ARXP 009/012/ 014/018 GLAH	ARXA 024/030/ 036/045 GLEH	ARXQ 018/024 GTAH	ARXP 024/030 GTAH	ARXC 036/072/ 090/096 GTEH	ARXC 45/60GATH	ARXQ 030GTAH	AGYA 004/007/ 009/012/014 GCGH	AGYE 004/007/ 009/012/014 GCEH	ABYA 012/014/ 018/024 GTEH	ABYA 030/036/ 045/054 GTEH	ASVA 004/007/009 GCGH	ASVE 004/007/009 GCEH	ASVA 012/014GCGH	ASVE 012/014GCEH	ASVA 18/24GBCH	ASVA 030/034GTEH		
Controllers		● UTY-RNRYZ5																										
		● UTY-RLRY																										
		● UTY-RCRYZ1																										
Simple remote controller		● UTY-RSRY UTY-RHRY	● UTY-RSRY, UTY-RHRY, UTY-RSKY, UTY-RHKY	● UTY-RSRY UTY-RHRY	● UTY-RSRY, UTY-RHRY, UTY-RSKY, UTY-RHKY	● UTY-RSRY UTY-RHRY	● UTY-RSRY, UTY-RHRY, UTY-RSKY, UTY-RHKY	● UTY-RSRY UTY-RHRY	● UTY-RSRY, UTY-RHRY, UTY-RSKY, UTY-RHKY	● UTY-RSRY UTY-RHRY	● UTY-RSRY, UTY-RHRY, UTY-RSKY, UTY-RHKY	● UTY-RSRY UTY-RHRY	● UTY-RSRY, UTY-RHRY, UTY-RSKY, UTY-RHKY	● UTY-RSRY UTY-RHRY	● UTY-RSRY, UTY-RHRY, UTY-RSKY, UTY-RHKY	● UTY-RSRY UTY-RHRY	● UTY-RSRY, UTY-RHRY, UTY-RSKY, UTY-RHKY	● UTY-RSRY UTY-RHRY	● UTY-RSRY, UTY-RHRY, UTY-RSKY, UTY-RHKY	● UTY-RSRY UTY-RHRY	● UTY-RSRY, UTY-RHRY, UTY-RSKY, UTY-RHKY	● UTY-RSRY UTY-RHRY	● UTY-RSRY, UTY-RHRY, UTY-RSKY, UTY-RHKY	● UTY-RSRY UTY-RHRY	● UTY-RSRY, UTY-RHRY, UTY-RSKY, UTY-RHKY	● UTY-RSRY UTY-RHRY		
Wireless remote controller		● UTY-LNHY																										
IR receiver unit		● UTY-TRHX	● UTY-LRHYB1	● UTY-LBHXD	● UTY-TRHX	● UTB-YWC	● UTY-TRHX	● UTB-YWC	● UTY-TRHX	● UTB-YWC	● UTY-TRHX	● UTB-YWC	● UTY-TRHX	● UTB-YWC	● UTY-TRHX	● UTB-YWC	● UTY-TRHX	● UTB-YWC	● UTY-TRHX	● UTB-YWC	● UTY-TRHX	● UTB-YWC	● UTY-TRHX	● UTB-YWC	● UTY-TRHX	● UTB-YWC	● UTY-TRHX	● UTB-YWC
Central remote controller		● UTY-DCGYZ2																										
Touch panel controller		● UTY-DTGYZ1																										
System controller, System controller Lite		● UTY-APGXZ1, UTY-ALGXZ1																										

Controller System List (available) for VRF

Controller Options:



Type	Refrigerant	Indoor unit														Indoor unit													
		Cassette						Duct								Floor		Wall-mounted											
		One-way flow	3D flow	Compact Grid type/ Standard type	Slim type		Large type		Low static pressure duct				Medium static pressure				-	external EEV	Ceiling/ Floor	Ceiling	-	external EEV	-	external EEV	-	-			
					4-way flow	Circular flow	Mini (With drain pump)	Slim (With drain pump)	Slim High-efficiency	Normal	High efficiency		Normal		High efficiency														
R410A		AUXV 004/007/009/ 012/014/018/ 024GLEH	AUXS 018/024 GLEH	AUXB 004/007/009/ 012/014/018/ 024GLEH	AUXD 18/24GALH	AUXA 18/24/30/ 34/36/45/54 GALH	AUXN 009/012/014 GLAH, AUXM 018/024/030 GLEH	AUXK 018/024/030/ 034/036/045/ 054GLEH	ARXK 004/007/009/ 012/014/018/ 024GLGH	ARXD 04GALH	ARXD 007/009/012/ 014/018/024 GLEH	ARXP 009/012/ 014/018 GLAH	ARXA 024/030/ 036/045 GLEH	ARXQ 018/024 GTAH	ARXP 024/030 GTAH	ARXC 036/072/ 090/096 GTEH	ARXC 45/60GATH	ARXQ 030GTAH	AGYA 004/007/ 009/012/014 GCGH	AGYE 004/007/ 009/012/014 GCEH	ABYA 012/014/ 018/024 GTEH	ABYA 030/036/ 045/054 GTEH	ASVA 004/007/009 GCGH	ASVE 004/007/009 GCEH	ASVA 012/014GCGH	ASVE 012/014GCEH	ASVA 18/24GBCH	ASVA 030/034GTEH	
Interfaces	BACnet® gateway	● UTY-ABGXZ1, UTY-VBGX														● UTY-ABGXZ1, UTY-VBGX													
	CN connector type	● FG-AC-BAC1Z1			● FG-AC-BAC1Z1			● FG-AC-BAC1Z1			● FG-AC-BAC1Z1			● FG-AC-BAC1Z1			● FG-AC-BAC1Z1					● FG-AC-BAC1Z1							● FG-AC-BAC1Z1
Network converter for LONWORKS®		● UTY-VLGX														● UTY-VLGX													
		● UTY-VMSX			● UTY-VMSX			● UTY-VMSX			● UTY-VMSX			● UTY-VMSX			● UTY-VMSX					● UTY-VMSX							● UTY-VMSX
MODBUS® Converter		● UTY-VMGX FG-TL-MBS16Z1														● UTY-VMGX FG-TL-MBS16Z1													
		● FG-AC-MBS1Z1		● FG-RC-MBS1Z1		● FG-AC-MBS1Z1		● FG-RC-MBS1Z1		● FG-AC-MBS1Z1		● FG-RC-MBS1Z1		● FG-AC-MBS1Z1		● FG-RC-MBS1Z1		● FG-AC-MBS1Z1		● FG-RC-MBS1Z1		● FG-AC-MBS1Z1		● FG-RC-MBS1Z1		● FG-AC-MBS1Z1		● FG-RC-MBS1Z1	● FG-AC-MBS1Z1
MODBUS® interface	3-wire RC-line type	● FG-AC-MBS1Z1		● FG-RC-MBS1Z1		● FG-AC-MBS1Z1		● FG-RC-MBS1Z1		● FG-AC-MBS1Z1		● FG-RC-MBS1Z1		● FG-AC-MBS1Z1		● FG-RC-MBS1Z1		● FG-AC-MBS1Z1		● FG-RC-MBS1Z1		● FG-AC-MBS1Z1		● FG-RC-MBS1Z1		● FG-AC-MBS1Z1		● FG-RC-MBS1Z1	● FG-AC-MBS1Z1
	CN connector type	● FG-AC-MBS1Z1		● FG-RC-MBS1Z1		● FG-AC-MBS1Z1		● FG-RC-MBS1Z1		● FG-AC-MBS1Z1		● FG-RC-MBS1Z1		● FG-AC-MBS1Z1		● FG-RC-MBS1Z1		● FG-AC-MBS1Z1		● FG-RC-MBS1Z1		● FG-AC-MBS1Z1		● FG-RC-MBS1Z1		● FG-AC-MBS1Z1		● FG-RC-MBS1Z1	● FG-AC-MBS1Z1
KNX® converter		● UTY-VKXS			● UTY-VKXS			● UTY-VKXS			● UTY-VKXS			● UTY-VKXS			● UTY-VKXS					● UTY-VKXS						● UTY-VKXS	
		● UTY-VKGX FG-TL-KNX16Z1														● UTY-VKGX FG-TL-KNX16Z1													
KNX® interface	3-wire RC-line type	● FG-AC-KNX1Z1		● FG-RC-KNX1Z1		● FG-AC-KNX1Z1		● FG-RC-KNX1Z1		● FG-AC-KNX1Z1		● FG-RC-KNX1Z1		● FG-AC-KNX1Z1		● FG-RC-KNX1Z1		● FG-AC-KNX1Z1		● FG-RC-KNX1Z1		● FG-AC-KNX1Z1		● FG-RC-KNX1Z1		● FG-AC-KNX1Z1		● FG-RC-KNX1Z1	● FG-AC-KNX1Z1
	CN connector type	● FG-AC-KNX1Z1		● FG-RC-KNX1Z1		● FG-AC-KNX1Z1		● FG-RC-KNX1Z1		● FG-AC-KNX1Z1		● FG-RC-KNX1Z1		● FG-AC-KNX1Z1		● FG-RC-KNX1Z1		● FG-AC-KNX1Z1		● FG-RC-KNX1Z1		● FG-AC-KNX1Z1		● FG-RC-KNX1Z1		● FG-AC-KNX1Z1		● FG-RC-KNX1Z1	● FG-AC-KNX1Z1
WLAN adapter	IR type	● FG-IR-KNX1Z1+UTY-TRHX	● FG-IR-KNX1Z1	● FG-IR-KNX1Z1+UTY-LRHYB1	● FG-IR-KNX1Z1+UTY-LBHXD	● FG-IR-KNX1Z1+UTY-TRHX	● FG-IR-KNX1Z1+UTB-YWC	● FG-IR-KNX1Z1+UTY-TRHX	● FG-IR-KNX1Z1+UTB-YWC	● FG-IR-KNX1Z1+UTY-TRHX	● FG-IR-KNX1Z1+UTB-YWC	● FG-IR-KNX1Z1+UTY-TRHX	● FG-IR-KNX1Z1+UTB-YWC	● FG-IR-KNX1Z1+UTY-TRHX	● FG-IR-KNX1Z1+UTB-YWC	● FG-IR-KNX1Z1+UTY-TRHX	● FG-IR-KNX1Z1+UTB-YWC	● FG-IR-KNX1Z1+UTY-TRHX	● FG-IR-KNX1Z1+UTB-YWC	● FG-IR-KNX1Z1+UTY-TRHX	● FG-IR-KNX1Z1+UTB-YWC	● FG-IR-KNX1Z1+UTY-TRHX	● FG-IR-KNX1Z1+UTB-YWC	● FG-IR-KNX1Z1+UTY-TRHX	● FG-IR-KNX1Z1+UTB-YWC	● FG-IR-KNX1Z1+UTY-TRHX	● FG-IR-KNX1Z1+UTB-YWC	● FG-IR-KNX1Z1+UTY-TRHX	● FG-IR-KNX1Z1+UTB-YWC
	CN connector type	● FG-IR-KNX1Z1+UTY-TRHX	● FG-IR-KNX1Z1	● FG-IR-KNX1Z1+UTY-LRHYB1	● FG-IR-KNX1Z1+UTY-LBHXD	● FG-IR-KNX1Z1+UTY-TRHX	● FG-IR-KNX1Z1+UTB-YWC	● FG-IR-KNX1Z1+UTY-TRHX	● FG-IR-KNX1Z1+UTB-YWC	● FG-IR-KNX1Z1+UTY-TRHX	● FG-IR-KNX1Z1+UTB-YWC	● FG-IR-KNX1Z1+UTY-TRHX	● FG-IR-KNX1Z1+UTB-YWC	● FG-IR-KNX1Z1+UTY-TRHX	● FG-IR-KNX1Z1+UTB-YWC	● FG-IR-KNX1Z1+UTY-TRHX	● FG-IR-KNX1Z1+UTB-YWC	● FG-IR-KNX1Z1+UTY-TRHX	● FG-IR-KNX1Z1+UTB-YWC	● FG-IR-KNX1Z1+UTY-TRHX	● FG-IR-KNX1Z1+UTB-YWC	● FG-IR-KNX1Z1+UTY-TRHX	● FG-IR-KNX1Z1+UTB-YWC	● FG-IR-KNX1Z1+UTY-TRHX	● FG-IR-KNX1Z1+UTB-YWC	● FG-IR-KNX1Z1+UTY-TRHX	● FG-IR-KNX1Z1+UTB-YWC	● FG-IR-KNX1Z1+UTY-TRHX	● FG-IR-KNX1Z1+UTB-YWC
External switch controller		● UTY-TFSXZ1														● UTY-TFSXZ1													
		● FG-AC-WIF1Z1		● FG-RC-WIF1Z1		● FG-AC-WIF1Z1		● FG-RC-WIF1Z1		● FG-AC-WIF1Z1		● FG-RC-WIF1Z1		● FG-AC-WIF1Z1		● FG-RC-WIF1Z1		● FG-AC-WIF1Z1		● FG-RC-WIF1Z1		● FG-AC-WIF1Z1		● FG-RC-WIF1Z1		● FG-AC-WIF1Z1		● FG-RC-WIF1Z1	● FG-AC-WIF1Z1
External switch controller		● FG-AC-WMP1Z1		● FG-RC-WMP1Z1		● FG-AC-WMP1Z1		● FG-RC-WMP1Z1		● FG-AC-WMP1Z1		● FG-RC-WMP1Z1		● FG-AC-WMP1Z1		● FG-RC-WMP1Z1		● FG-AC-WMP1Z1		● FG-RC-WMP1Z1		● FG-AC-WMP1Z1		● FG-RC-WMP1Z1		● FG-AC-WMP1Z1		● FG-RC-WMP1Z1	● FG-AC-WMP1Z1
		● FG-IR-WMP1Z1+UTY-TRHX	● FG-IR-WMP1Z1	● FG-IR-WMP1Z1+UTY-LRHYB1	● FG-IR-WMP1Z1+UTY-LBHXD	● FG-IR-WMP1Z1+UTY-TRHX	● FG-IR-WMP1Z1+UTB-YWC	● FG-IR-WMP1Z1+UTY-TRHX	● FG-IR-WMP1Z1+UTB-YWC	● FG-IR-WMP1Z1+UTY-TRHX	● FG-IR-WMP1Z1+UTB-YWC	● FG-IR-WMP1Z1+UTY-TRHX	● FG-IR-WMP1Z1+UTB-YWC	● FG-IR-WMP1Z1+UTY-TRHX	● FG-IR-WMP1Z1+UTB-YWC	● FG-IR-WMP1Z1+UTY-TRHX	● FG-IR-WMP1Z1+UTB-YWC	● FG-IR-WMP1Z1+UTY-TRHX	● FG-IR-WMP1Z1+UTB-YWC	● FG-IR-WMP1Z1+UTY-TRHX	● FG-IR-WMP1Z1+UTB-YWC	● FG-IR-WMP1Z1+UTY-TRHX	● FG-IR-WMP1Z1+UTB-YWC	● FG-IR-WMP1Z1+UTY-TRHX	● FG-IR-WMP1Z1+UTB-YWC	● FG-IR-WMP1Z1+UTY-TRHX	● FG-IR-WMP1Z1+UTB-YWC	● FG-IR-WMP1Z1+UTY-TRHX	● FG-IR-WMP1Z1+UTB-YWC

Optional parts overview

For Split & Multi-split, VRF

A variety of optional parts are available to enable installation of the selected indoor unit properly according to the environment.

Optional Parts For Cassette



Human sensor kit
A built-in thermo sensor monitors and controls room temperature accurately.

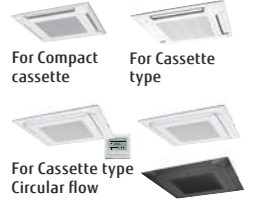

Cassette grille
A lineup of cassette grilles that match a variety of interiors. A grid ceiling-type cassette grille has been added to the lineup.

For Compact cassette For Cassette type
For Cassette type Circular flow



Silver ion filter
The Silver ion filter helps to keep indoor air free from viruses, bacteria and molds.*



Fresh air intake kit
Fresh air can be taken in by a fan connected to an external control unit.

For Compact cassette For Cassette type

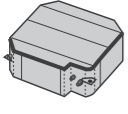

Insulation kit for high humidity
for Compact cassette type/Cassette type
Insulation kit for high humidity is used when the installation location is in a high humidity environment.

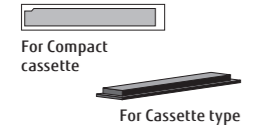

Air outlet shutter plate
Airflow directions can be changed to 3 directions using the Air outlet shutter plate depending on the installation location.

For Compact cassette For Cassette type

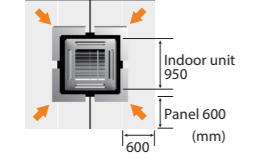

Wide Panel
When a cassette type is installed in a narrow space in the ceiling, the wide panel fills in that space.

Indoor unit 950
Panel 600 (mm)
600

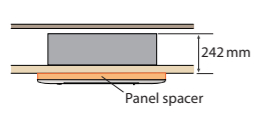

Panel spacer
If the ceiling space is tight and the main body protrudes from the ceiling surface, a panel spacer can be used as a decorative trim.

242 mm
Panel spacer

Optional Parts For V-III



Pressure sensor kit
The height difference of the pressure sensor kit can be extended up to 110 m.

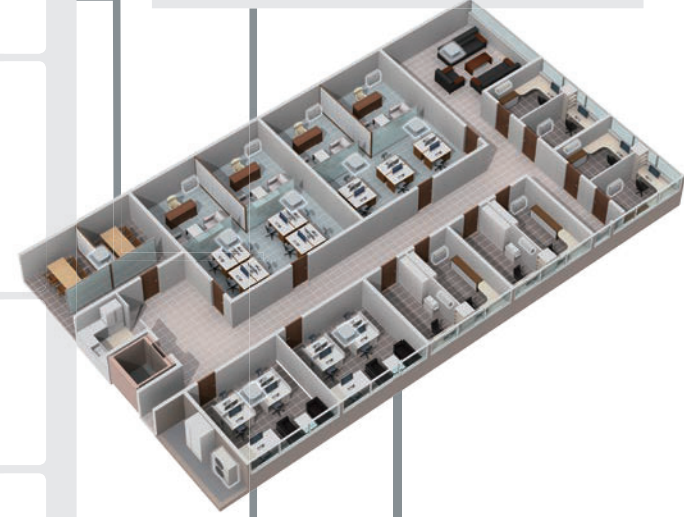



Optional Parts For Floor

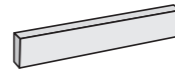

Half concealed kit
Used to half conceal a floor type indoor unit in the wall.



Silver ion filter
The Silver ion filter helps to keep indoor air free from viruses, bacteria and molds.*



Optional Parts For Duct & Ceiling



Auto louver grille kit
The optional clean-looking flat Auto louver grille blends into any interior and provides a comfortable airflow.



Remote sensor unit
The remote sensor provides additional convenience.

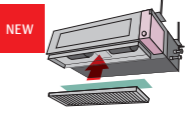

Silver ion filter
The Silver ion filter helps to keep indoor air free from viruses, bacteria and molds.*



Long-life filter
Captures grit and dust. Long-life design with consideration of running costs.



Flange
Flanges are used when connecting a medium static pressure duct type and a ceiling type with air intake and exhaust ducts.



Drain pump unit
Drains water that has accumulated during operation.

Connection Parts



Communication kit
Required for a wall-mounted type when the External connect kit set or a Wired remote controller is connected to the indoor unit.

For wall-mounted type



External input and output PCB
For Wall-mounted, Duct, or Cassette type, these parts are required when the external input and output function is used.

For wall-mounted type

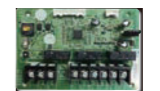

For Duct type and Cassette type

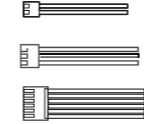

External connect kit & set
Connect the printed circuit board (PCB) to external devices.



Connection Units
Connection units are available to separate the pipes when connecting multiple indoor units in a Multi-split type or VRF system.



External power supply unit
The External power supply unit protects the increment in the system even if the power supply for some of the indoor units is shut down.

*Not a result of experiments in an actual use environment. Silver ion filter inhibits activity or growth of microorganism, but do not prevent infection.

Silver Ion Filter

UTR-FA16-5 / UTR-FA13-3 / UTR-FA03-5 / UTD-HFAA / UTD-HFRA / UTD-HFTA / UTD-HFTB / UTD-HFTC / UTD-HFNC / UTD-HFNB / UTD-HFNA / UTD-HFND / UTD-HFKB / UTD-HFKA



NEW



For Wall mounted / Floor
UTR-FA16-5 / UTR-FA13-3
UTR-FA03-5

For Cassette
UTD-HFAA / UTD-HFRA

For Duct
UTD-HFTA / UTD-HFTB
UTD-HFTC / UTD-HFNC
UTD-HFNB / UTD-HFNA
UTD-HFND / UTD-HFKB
UTD-HFKA

The Silver ion filter helps to keep indoor air free from viruses, bacteria and molds.

(Not a result of experiments in an actual use environment. Silver ion filter inhibits activity or growth of microorganism, but do not prevent infection.)

The silver ion filter inhibits the activities of viruses*1, bacteria*2 and molds*3 trapped on the filter.

(Only effective when the microorganism is trapped on the filter with dust or droplet)

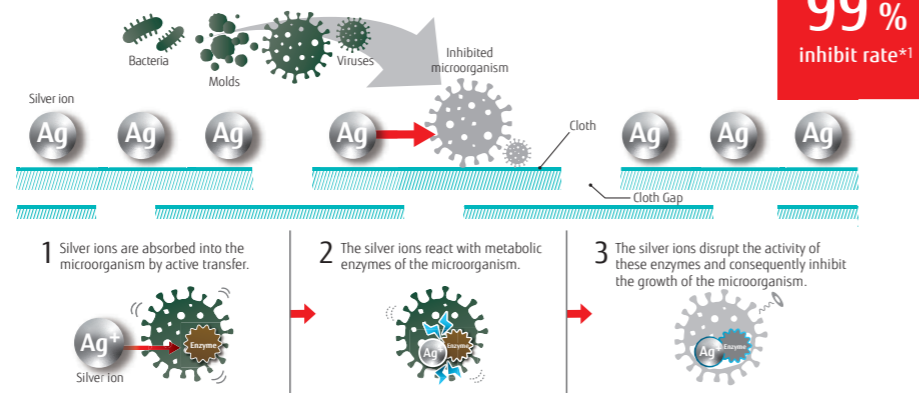

*1 [Testing organization] Kitasato Research Center for Environmental Science [Test Report] No. 2020_0408 [Test virus] Escherichia coli phage Qbeta NBRC 20012 (1 type) [Test Method] Based on the antiviral test method for textile products (JIS L 1922) [Test results] Inhibited by at least 99% in 24 hours. Not tested to prevent transmission of SARS-CoV-2.

*2 [Testing organization] Kitasato Research Center for Environmental Science [Test Report] No. 2020_0409 [Test bacteria] Escherichia coli NBRC 3972 (1 type) [Test Method] Based on the determination of antibacterial activity and efficacy of textile products (JIS L 1902) [Test results] The growth of the test bacteria was inhibited by 24 hours testing

*3 [Testing organization] Kitasato Research Center for Environmental Science [Test Report] No. 2020_0410 [Test fungi] Aspergillus Niger NBRC 105649 and other fungi (3 types) [Test Method] Based on the test for fungus resistance (JIS Z 2911) [Test results] The growth of the fungus was inhibited by 28 days testing

The filter is easily removable* and hand-washable.

(*Wall mounted and floor models only)

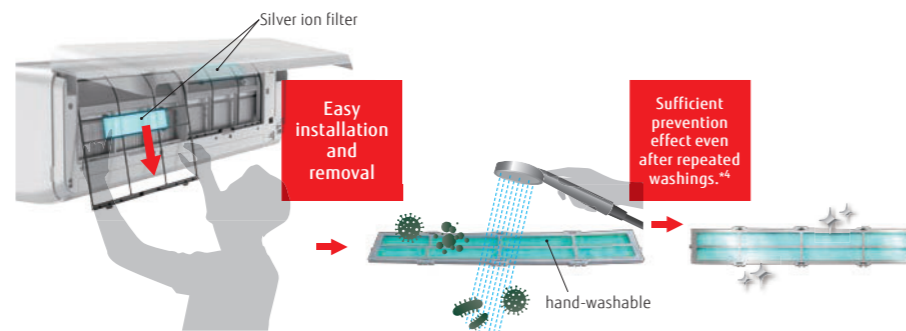

*4 Hand-washing or vacuuming by 3 months is recommended. Cleaning frequency varies depending on the environment of use.

Specifications

Model name	For Wall mounted / Floor			for Cassette		
	UTR-FA16-5	UTR-FA13-3	UTR-FA03-5	UTD-HFAA	UTD-HFRA	
Net Dimension (H x W x D)	mm	35 x 210 x 6	50 x 364 x 6	43 x 272 x 6	350 x 125 x 6	550 x 136 x 6
Weight	g	2	2	2	7	23
Quantity		2	2	2	1	1

Model name	for Duct									
	UTD-HFTA	UTD-HFTB	UTD-HFTC	UTD-HFNC	UTD-HFNB	UTD-HFNA	UTD-HFND	UTD-HFKB	UTD-HFKA	
Net Dimension (H x W x D)	mm	290 x 70 x 6	390 x 70 x 6	290 x 70 x 6 390 x 70 x 6	620 x 88 x 6	420 x 88 x 6	620 x 88 x 6	500 x 79 x 6	420 x 125 x 6	620 x 108 x 6
Weight	g	6	8	10	8	10	16	12	16	20
Quantity		2	2	3	1	2	2	2	2	2

Auto louver grille kit

UTD-GXTA-W/UTD-GXTB-W/UTD-GXTC-W



The optional clean-looking flat Auto louver grille kit blends into any interior and provides a comfortable airflow.



Flexible Control

- The Auto louver grille of the indoor unit can be operated in conjunction with the remote control of the indoor unit.
- Vertical auto swing**
 - Auto airflow direction and auto swing
 - 4 steps selectable
- Auto-closing louver**
 - The louvers will automatically close when the indoor unit stops operating.

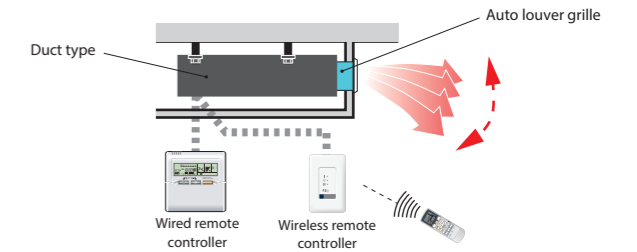

Dimensions

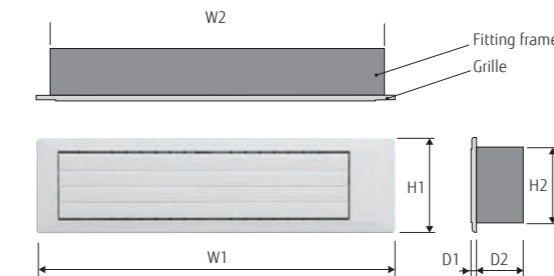

Model name	W1	W2	H1	H2	D1	D2
UTD-GXTA-W	683	645	180	148	9	84
UTD-GXTB-W	883	845	180	148	9	84
UTD-GXTC-W	1,083	1,045	180	148	9	84

Unit: mm

Specifications

Model name	UTD-GXTA-W	UTD-GXTB-W	UTD-GXTC-W		
Applicable indoor unit	ARYG07/09LLTA ARYG12/14LLTB ARXD007/009/012/014GLEH (for VRF) ARXK004/007/009/012/014GLEH (for VRF) ARXD04GALH (for VRF)	ARYG18LLTB ARXD018GLEH (for VRF) ARXK018GLEH (for VRF)	ARXD024GLEH (for VRF) ARXK024GLEH (for VRF)		
Power supply	Connecting with Control box of indoor unit				
Fixing Auto louver grille	Screwed to Flange or Square duct				
Extension Square duct limit	1.0 m (Max. duct length between indoor unit and Auto louver grille)				
Net Dimensions (H x W x D)	mm	180 x 683 x (84 + 9)	180 x 883 x (84 + 9)	180 x 1,083 x (84 + 9)	
Weight	Net	kg	2.0 (4.4)	2.5 (5.6)	3.0 (6.7)
	Gross	(lbs)	3.0 (6.7)	3.5 (7.8)	4.0 (8.9)
Color	White				
Louver motor	Stepping motor				
Accessories	Fitting Flame, etc.				
Operating range	Cooling	°C	18 to 32		
		% RH	80 % or less		
Operating range	Heating	°C	16 to 30		

Pressure sensor kit

UTY-SPWX



NEW



Design flexibility

The height difference between the outdoor unit and the indoor unit is normally 50 m for the V-III Series, but can be extended to 110 m by installing the Pressure sensor kit. (Can only be connected to the V-III Series. Also, it can only be connected to outdoor units using outdoor unit software compatible with the product.)

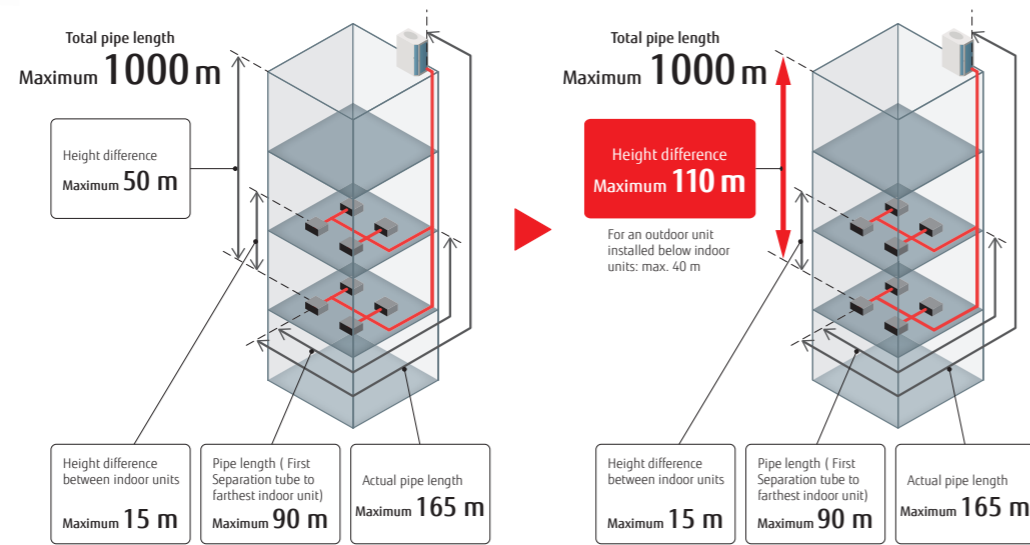

System overview

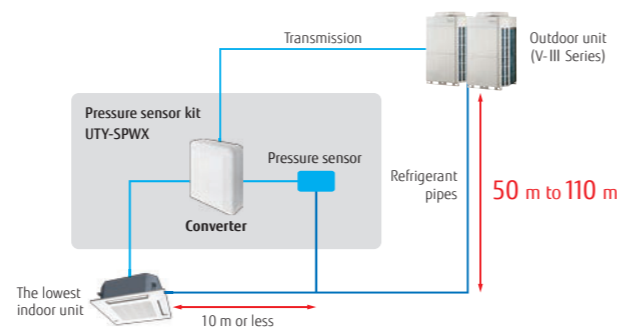

Pressure sensor kit

Pressure sensor kit (Converter)	Refrigerant pressure sensor	Joint pipe

Specifications

Model name	UTY-SPWX
Power supply	9 to 16 V DC
Dimensions (H × W × D) (mm)	140 × 117 × 43
Weight (g)	200

External power supply unit

UTZ-GXXC



NEW



The External power supply unit protects the increment in the system even if the power supply for some of the indoor units is shut down.

Connects to the External power supply unit to supply power to the indoor unit from the auxiliary power supply. This allows for continuous operation without system errors. Built-in relays reduce installation time and cost.

High reliability

- A: Interruption of the main power supply is detected by the power cut-off detection part.
- B: Supplies power for driving the expansion valve of the indoor unit. (12 V or 5 V DC)
- C: Gives notification of the power supply from the External power supply unit.

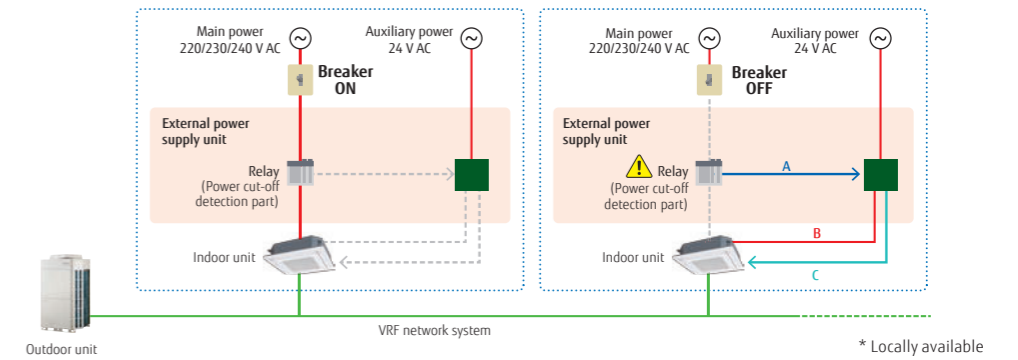

Note

- When changing the power supply voltage to 24 V AC, use a power transformer with an insulated structure that complies with the regulations* of the installation region.
- A powered-off indoor unit driven by the External power supply unit is treated in the same way as an operation-off unit in the electricity charge appointment function. If standby power is generated, the result of the electricity charge appointment may not be zero.

* UL Class II or IEC 61558 Class III, for example.

Specifications

Model name	UTZ-GXXC
Power supply	24 V AC 50/60 Hz
Dimensions (H × W × D) (mm)	97 × 200 × 178
Weight (g)	800

AIR BEAM Radiation air outlet unit

*Production by order
Contact us for more details.



Key component

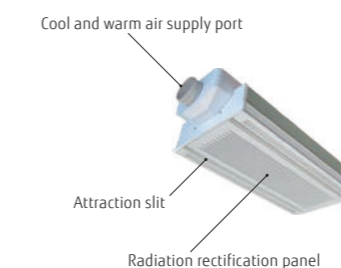

Cross-section view

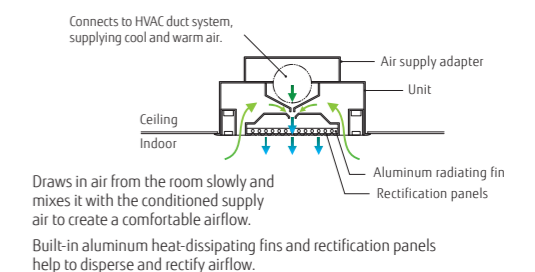

Airflow rate (m ³ /h)	180 (160-215)	270 (240-325)
Grid	600 × 2	600 × 3
AIR BEAM For system ceiling (Integrated type)	KS-180	KS-270

Optional parts list for Split/Multi-split



Type	Refrigerant	Indoor unit							Indoor unit						
		Cassette		Duct			Duct	Floor	Ceiling	Wall-mounted	Multi-split				
		4-way flow Compact	Circular flow	Slim	Medium static pressure (Compact)	Medium static pressure (Standard)	High static pressure				Big	4-way flow Compact cassette	Mini duct	Slim duct	Floor ceiling
		AUXG 09/12/14/ 18/22/24 KVLA	AUXG 18/22/24/ 30/36/45/54 KRLB	ARXG 09/12/14/18 KLLAP	ARXG 12/14/18/22/ 24/30/36/45/54 KHTAP	ARXG 22/24/30/36/45 KMLA	ARXG45/54KHTA					AUXG07KVLA	ARXG 07/09/12/14/18 KSLAP	ARXG07KLLAP	
							ARYG45/54/60LHTA	ARYG72/90LHTA				AUYG07/09LVLA	ARYG07/09LSLAP	ARYG07/09LLTA	ABYG14LVTA
Human sensor kit			• UTY-SHZXC												
Remote sensor unit	 The remote sensor provides additional convenience.				• UTY-XSZX			• UTY-XSZX						• UTY-XSZX	
Cassette grille		• UTG-UFYF-W	• UTG-UKYA-W, UTG-UKYCW, UTG-UKYA-B									• UTG-UFYF-W (KVLA), UTG-UFYD-W (LVLA)			
Auto louver grille kit				• UTD-GXTA-W (09/12/14) UTD-GXTB-W (18)										• UTD-GXTA-W (07/09/12/14), UTD-GXTB-W (18)	
Long-life filter					• UTD-LFNA (36/45/54) UTD-LFNB (18/22/24/30) UTD-LFNC (12/14)	• UTD-LF25NA	• UTD-LF60KA (45/54)	• UTD-LFKA							
Flange						• UTD-SF04ST UTD-RF204									
Drain pump unit						• UTZ-PX1NBA		• UTZ-PX1NAB			• UTR-DPB24T				
Wide Panel			• UTG-AKXA-W												
Panel spacer			• UTG-BKXA-W												
Fresh air intake kit	 For Compact cassette For Cassette type	• UTZ-VXAA	• UTZ-VXRA									• UTZ-VXAA			
Air outlet shutter plate	 For Compact cassette For Cassette type	• UTR-YDZB	• UTR-YDZK									• UTR-YDZB			
Insulation kit for high humidity	 For Compact cassette Series/ Cassette type	• UTZ-KXGC	• UTZ-KXRA									• UTZ-KXGC			
Half concealed kit	 Used to half conceal a floor type indoor unit in the wall.								• UTR-STA						
L-type piping kit											• UTP-FX24A (18/22/24) UTP-FX35A (30/36/45/54)				
Remote controller holder												• UTZ-RXLA			

Separation tube



For SPLIT/MULTI-SPLIT/SIMULTANEOUS MULTI-SPLIT

Separation tube		Branch box	
UTP-SX236A/UTP-SX254A For 3-phase simultaneous multi-split UTP-SX272A For Simultaneous multi-split Twin/ Triple/Double Twin 	UTP-SX354A For 3-phase simultaneous multi-split UTP-SX372A For Simultaneous multi-split Twin/ Triple/Double Twin 	UTP-SX248A For 8-unit multi-split Liquid pipe Gas pipe 	UTP-PY03A UTP-PY02A For 8-unit multi-split 3-zone type 2-zone type



for VRF

Separation tube			
UTP-AX054A Gas pipe Liquid pipe 	UTP-AX090A Gas pipe Liquid pipe 	UTP-AX180A Gas pipe Liquid pipe 	UTP-AX567A Gas pipe Liquid pipe
UTP-BX090A Suction Gas pipe Discharge Gas pipe Liquid pipe 	UTP-BX180A Suction Gas pipe Discharge Gas pipe Liquid pipe 	UTP-BX567A Suction Gas pipe Discharge Gas pipe Liquid pipe 	UTP-LX180A For DX kit

Header

UTR-H0906L/UTR-H1806L Gas pipe Liquid pipe 	UTR-H0908L/UTR-H1808L Gas pipe Liquid pipe 	UTP-J0906A/UTP-J1806A Suction gas pipe Discharge gas pipe Liquid pipe 	UTP-J0908A/UTP-J1808A Suction gas pipe Discharge gas pipe Liquid pipe
--	--	--	--

Outdoor unit branch kit

Outdoor unit branch kit	Separation tube for RB unit		
UTP-CX567A Gas Pipe Liquid Pipe 	UTP-DX567A Suction Gas Pipe Discharge Gas Pipe Liquid Pipe 	UTP-EX060A Gas Pipe Liquid Pipe 	UTP-EX096A Gas Pipe Liquid Pipe

for VRF

EV kit
Model name \leq 09: UTR-EV09XB Model name \geq 12: UTR-EV14XB for compact wall-mounted type

RB unit			
UTP-RX01AH/UTP-RX01BH/ UTP-RX01CH Single type 	UTP-RX04BH Multi-split type 	UTP-RX08AH Multi-split type 	UTP-RX12AH Multi-split type

Specifications

Separation tube

Model name	UTP-AX054A	UTP-AX090A	UTP-AX180A	UTP-AX567A
Total cooling capacity of indoor unit (kW)	19.6 or less	28.0 or less	28.1 to 56.0	56.1 or more

Model name	UTP-BX090A	UTP-BX180A	UTP-BX567A
Total cooling capacity of indoor unit (kW)	28.0 or less	28.1 to 56.0	56.1 or more

Header

Model name	3-6 Branches	UTR-H0906L	UTR-H1806L
	3-8 Branches	UTR-H0908L	UTR-H1808L
Total cooling capacity of indoor unit (kW)	28.0 or less		28.1 to 56.0

Model name	3-6 Branches	UTP-J0906A	UTP-J1806A
	3-8 Branches	UTP-J0908A	UTP-J1808A
Total cooling capacity of indoor unit (kW)	28.0 or less		28.1 to 56.0

Outdoor unit branch kit

Model name	UTP-CX567A (for V-III/V-III Tropical)	UTP-DX567A (for VR-IV)
Number of outdoor units	2 outdoor units	1
	3 outdoor units	2

EV kit

Model name	UTR-EV09XB		UTR-EV14XB	
Application model	ASYE004GCEH ASYE007GCEH ASYE009GCEH	AGYE004GCEH AGYE007GCEH AGYE009GCEH	ASYE012GCEH ASYE014GCEH	AGYE012GCEH AGYE014GCEH

RB unit

Type	Single type			Multi-split type			
	Model name	UTP-RX01AH	UTP-RX01BH	UTP-RX01CH	UTP-RX04BH	UTP-RX08AH	UTP-RX12AH
Power source	V/Ø/Hz	230/1/50					
Input power	W	17	24	31	96	136	204
Number of branches		1	1	1	4	8	12
Maximum capacity of connectable indoor units (Q)	kW	Q \leq 8.0	Q \leq 18.0	Q \leq 28.0	Q \leq 56.1*1	Q \leq 72.0	Q \leq 95.0
Maximum capacity of connectable indoor units per branch (Q)	kW	Q \leq 8.0	Q \leq 18.0	Q \leq 28.0	Q \leq 18.0	Q \leq 8.0	Q \leq 8.0
Maximum Connectable Indoor Units per Branch		3	8	8	8	7	7
Dimensions (H × W × D)	mm	198 × 298 × 268			260 × 658 × 428	298 × 660 × 618	298 × 990 × 618

*1: When two RB units are connected in series (8 branches in total), the maximum capacity of the connectable indoor units is up to 56.0 kW.

Residential AIR TO WATER

- W-002 WATERSTAGE™ Overview
- W-004 WATERSTAGE™ Lineup
- W-006 Benefits
- W-008 Home Heating & Domestic Hot Water Supply
- W-010 High-Efficiency Technology
- W-012 Split Type
 - Comfort Series
 - Super High Power Series
 - High Power Series
- W-018 Split DHW Integrated Type
 - Comfort Series
 - Super High Power Series
 - High Power Series
- W-024 Control Overview
- W-026 Comfort Control
- W-028 System Configuration
- W-030 Case Studies
- W-032 Simple installation
 - Easy Installation & Maintenance
- W-034 Installation Requirements
- W-036 AIR TO WATER Optional Parts



WATERSTAGE™

Innovative solutions for Home Heating

SPLIT TYPE/SPLIT DHW INTEGRATED TYPE

AIR TO WATER
Residential



FUJITSU GENERAL LIMITED

WATERSTAGE™ Overview

Solutions that meet a variety of needs

Water heated by WATERSTAGE™ using clean energy is delivered reliably and comfortably throughout the house, including the living room, bedrooms, bathrooms—even a swimming pool.

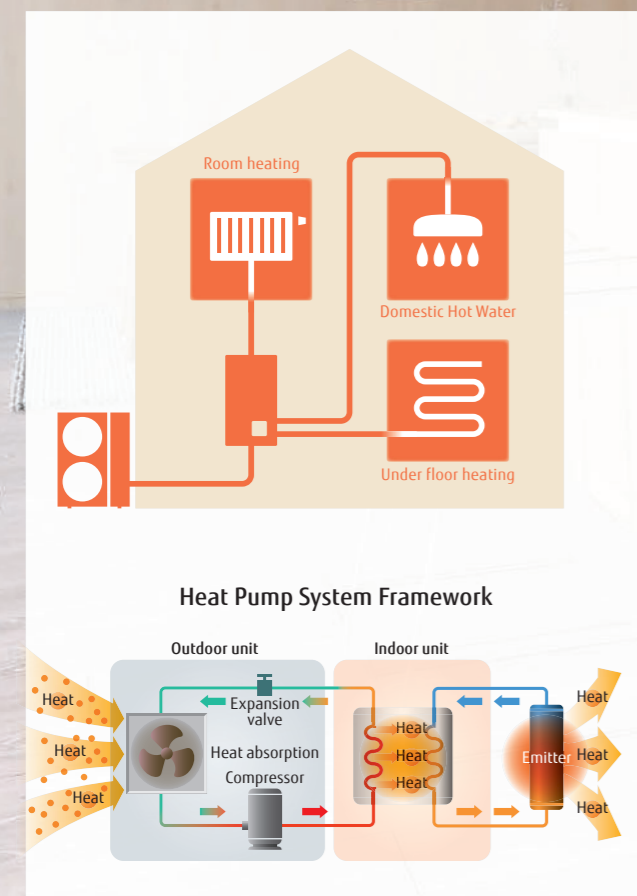

27 Models

Fujitsu General WATERSTAGE™ heat pumps offer a variety of high-efficiency renewable central heating systems that absorb energy primarily from the air.



Optimized refrigerant cycle operation

Super High Power and High Power Series deliver high performance and efficiency with twin sensors and hot water heating technology.

Split Type

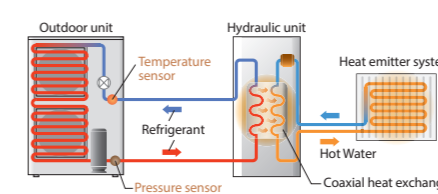

Split DHW Integrated Type

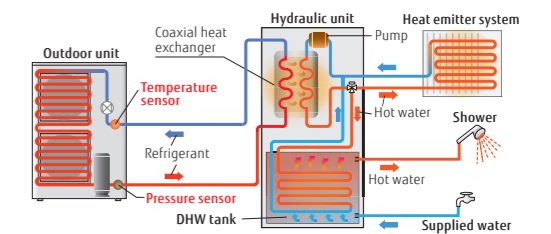

What is a heat pump?

A heat pump extracts heat energy from the atmosphere. It requires only 1 kW of electricity to generate 3 to 5 kW of thermal energy.

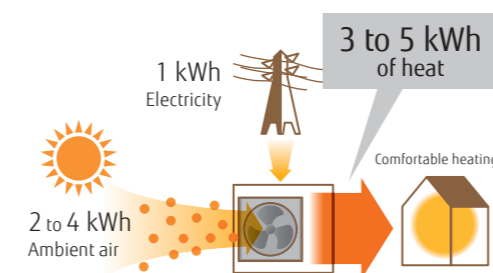

Primary energy usage reduced substantially

Proportion of primary energy converted into heating energy is 100%

Primary Energy Consumption*

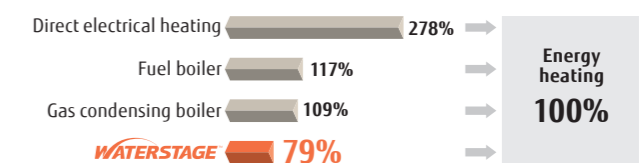

* The amount of electricity loss varies according to the power plant. Typical energy efficiency of a power plant: 36%

WATERSTAGE™ Lineup



Type	Split Type						Split DHW Integrated Type					
	Super High Power Series		High Power Series		Comfort Series		Super High Power Series		High Power Series		Comfort Series	
Hydraulic unit												
Outdoor unit												
Capacity range	15/16/17 kW		11/14 kW 11/14/16 kW		5/6 kW 8 kW 10 kW		15/16/17 kW		11/14 kW 11/14/16 kW		5/6 kW 8 kW 10 kW	
System outline	<ul style="list-style-type: none"> Supplies 60°C hot water even when the outdoor temperature is -20°C. Supplies 55°C hot water even when the outdoor temperature is -22°C. Can be used with a variety of heating systems, including underfloor heating and radiators.* Heating and DHW supply in one system.* Equipped with additional electric heater for backup Up to two independent control circuits.* Cooling operation is possible.* Operating range is -25 to 35°C. 		<ul style="list-style-type: none"> Supplies 60°C hot water even when the outdoor temperature is -20°C. Can be used with a variety of heating systems, including underfloor heating and radiators.* Heating and DHW supply in one system.* Equipped with additional electric heater for backup Up to two independent control circuits.* Cascade connection is possible for up to three systems.* Cooling operation is possible.* Operating range is -25 to 35°C. 		<ul style="list-style-type: none"> Supplies 55°C hot water even when the outdoor temperature is -22°C. Heating and DHW supply in one system.* Equipped with additional electric heater for backup Up to two independent control circuits.* Cooling operation is possible.* Operating range is -20 to 35°C. Can be used with a variety of heating systems, including underfloor heating and radiators.* 		<ul style="list-style-type: none"> Supplies 60°C hot water even when the outdoor temperature is -20°C. Supplies 55°C hot water even when the outdoor temperature is -22°C. Can be used with a variety of heating systems, including underfloor heating and radiators.* Space saving heating and DHW supply in a single Hydraulic unit Equipped with additional electric heater for backup Up to two independent control circuits.* Cooling operation is possible.* Operating range is -25 to 35°C. 		<ul style="list-style-type: none"> Supplies 60°C hot water even when the outdoor temperature is -20°C. Can be used with a variety of heating systems, including underfloor heating and radiators.* Space saving heating and DHW supply in a single Hydraulic unit Equipped with additional electric heater for backup Up to two independent control circuits.* Cooling operation is possible.* Operating range is -25 to 35°C. 		<ul style="list-style-type: none"> Supplies 55°C hot water even when the outdoor temperature is -22°C. Heating and DHW supply in one system. Equipped with additional electric heater for backup Up to two independent control circuits.* Cooling operation is possible.* Operating range is -20 to 35°C. Can be used with a variety of heating systems, including underfloor heating and radiators.* 	
Power source	Single phase, ~230 V, 50 Hz	3-phase, ~400 V, 50 Hz	Single phase, ~230 V, 50 Hz	3-phase, ~400 V, 50 Hz	Single phase, ~230 V, 50 Hz		Single phase, ~230 V, 50 Hz	3-phase, ~400 V, 50 Hz	Single phase, ~230 V, 50 Hz	3-phase, ~400 V, 50 Hz	Single phase, ~230 V, 50 Hz	
Capacity	5 kW				WSYA050ML3 WOYA060KLT						WGYA050ML3 WOYA060KLT	
	6 kW				WSYA080ML3 WOYA060KLT						WGYA080ML3 WOYA060KLT	
	8 kW				WSYA080ML3 WOYA080KLT						WGYA080ML3 WOYA080KLT	
	10 kW				WSYA100ML3 WOYA100KLT						WGYA100ML3 WOYA100KLT	
	11 kW			WSYG140DG6 WOYG112LHT	WSYK160DG9 WOYK112LCTA				WGYG140DG6 WOYG112LHT	WGYK160DG9 WOYK112LCTA		
	14 kW			WSYG140DG6 WOYG140LCTA	WSYK160DG9 WOYK140LCTA				WGYG140DG6 WOYG140LCTA	WGYK160DG9 WOYK140LCTA		
	15 kW		WSYK170DJ9 WOYK150LJL						WGYK170DJ9 WOYK150LJL			
	16 kW	WSYG160DJ6 WOYG160LJL			WSYK160DG9 WOYK160LCTA			WGYG160DJ6 WOYG160LJL		WGYK160DG9 WOYK160LCTA		
17 kW		WSYK170DJ9 WOYK170LJL						WGYK170DJ9 WOYK170LJL				

*Optional parts required

Benefits

Less
CO₂ Emissions

WATERSTAGE™ is an environmentally friendly system that emits substantially less carbon dioxide than conventional gas and hydrocarbon combustion systems.

Average annual CO₂ emissions

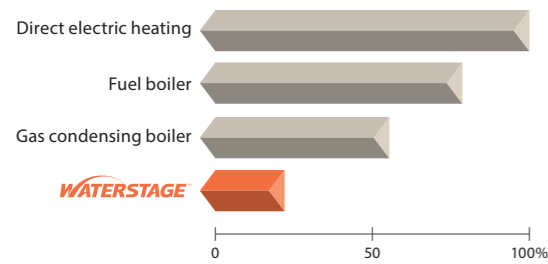

*Calculations based on energy efficiency data provided by the European Programme for Energy Efficiency in EU-27: 89% for fuel boilers; 93% for gas boiler

Clean
and Healthy

As a WATERSTAGE™ system does not use a burner to heat water, it does not produce NO_x or other harmful substances.



Environmentally friendly heating system



Low
Running Cost

High-efficiency heat pump technology keeps the running cost of a WATERSTAGE™ system.

Average annual running cost

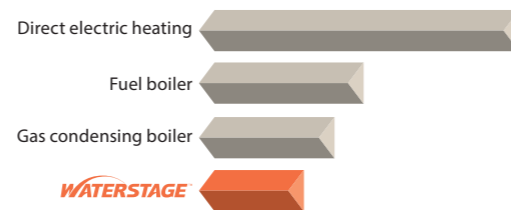

*The running cost may vary depending on a system's installation, geographical location, and operating conditions.

Easy
Installation and Maintenance

All components are built into a compact outdoor unit or a Hydraulic unit.



Well-designed Hydraulic unit
The sophisticated arrangement of Hydraulic units makes piping and maintenance work easy.

Energy Efficiency Standards Product labels

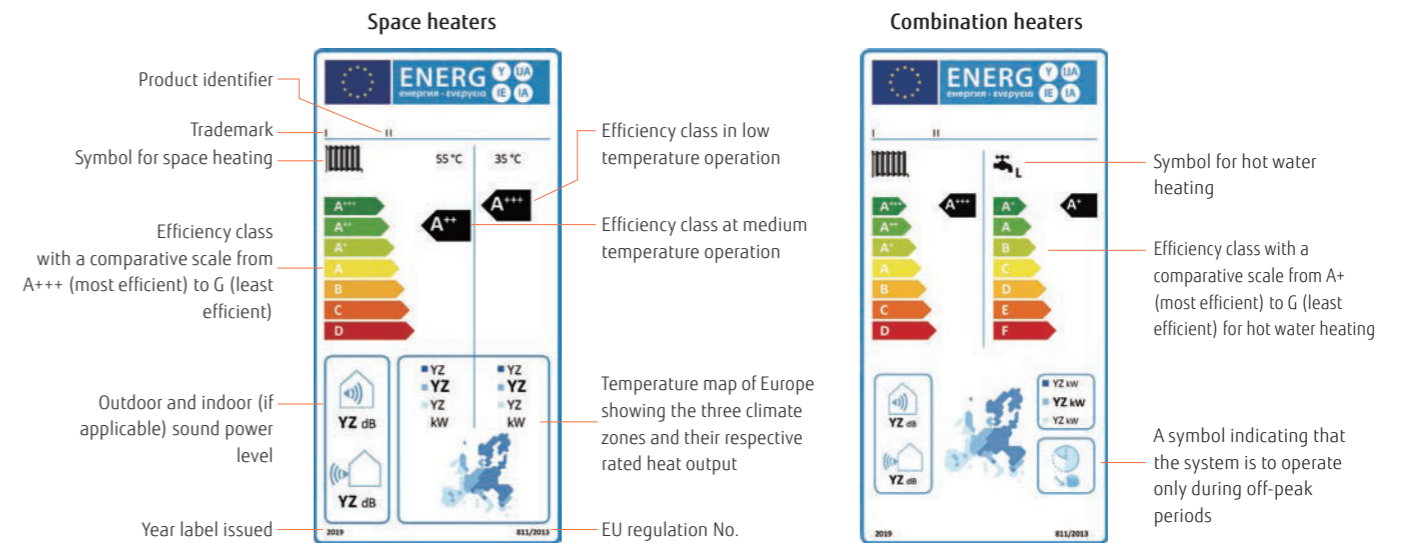

The Ecodesign Directive Lot 1 Regulation 813/2013

The Ecodesign directive defines a regulatory framework for improving the environmental performance of energy-related products (ErP) through design. Since September 26, 2015, the Ecodesign Directive has applied to space heaters, including heat pumps and fossil fuel fired boilers, combination heaters for space and hot water heating, water heaters, and water storage tanks.

All of these products must meet minimum requirements for energy efficiency*¹ and maximum sound power level. The minimum energy efficiency class were raised on September 26, 2017, and the maximum sound levels were lowered on September 26, 2018.

*1: Energy efficiency is expressed in terms of seasonal space heating efficiencies (η_s). The value is based upon the Seasonal Coefficient of Performance (SCOP).

The Energy Labelling Directive (EU) No. 811/213

Energy label is intended to enable consumers to make direct comparisons of energy use and product features. All labels should indicate the product identifier, efficiency class, sound power level, and heat output. Heat generators are rated A+++ to D. There are two different product labels. One for space heaters and one for combination heaters.

Seasonal space heating Energy efficiency class

Class	Except low temp. HP 55°C	Low temp. HP 35°C
A+++	η _s ≥ 150	η _s ≥ 175
A++	125 ≤ η _s < 150	150 ≤ η _s < 175
A+	98 ≤ η _s < 125	123 ≤ η _s < 150
A	90 ≤ η _s < 98	115 ≤ η _s < 123
B	82 ≤ η _s < 90	107 ≤ η _s < 115
C	75 ≤ η _s < 82	100 ≤ η _s < 107
D	36 ≤ η _s < 75	61 ≤ η _s < 100
E	34 ≤ η _s < 36	59 ≤ η _s < 61
F	30 ≤ η _s < 34	55 ≤ η _s < 59
G	η _s < 30	η _s < 55

EHPA Quality Label



Fujitsu General's WATERSTAGE™² has acquired the EHPA Quality Label³ through testing in accordance with the International Standards EN14511 and EN17025. The EHPA Quality Label³ is a label that shows the end-consumer a quality heat pump unit on the market.

*2: 3-phase High Power Series only
*3: Learn more about the validity of the mark at www.ehpa.org/quality/quality-label/

SG ready Label



SG ready is a label issued to heat pumps and their control technologies that meet the requirements set by BWV⁴, and technologies that conform to their standards can be integrated into a smart grid. SG ready labeled heat pumps receive signals from the power grid and PV systems with regard to energy and renewable energy sources such as wind, solar, and water. All of Fujitsu General's new heat pump series are SG ready compatible.

*4: BWP: Bundesverband Wärmepumpe e. V (Federal German Heat Pump Association)

The CEN Heat Pump KEYMARK



The Heat Pump KEYMARK is a full certificate supporting the quality of heat pumps in the European market. The Heat Pump KEYMARK is a voluntary, independent, European certification mark (ISO Type 5 Certification) for all heat pumps, combination heat pumps, and hot water heaters (as covered by Ecodesign, EU Regulation 813/2013 and 814/2013). Fujitsu General's WATERSTAGE™⁵ has acquired the KEYMARK certificate⁶.

*5: R32 refrigerant comfort model only
*6: Learn more about the validity of the mark at www.heatpumpkeymark.com/about/

Home Heating & Domestic Hot Water Supply

A wide range of products to suit regional characteristics, family structures, and usage patterns. We provide a variety of products to meet the needs of customers from the heating-centered High Power Series to the reasonably priced Compact Series.

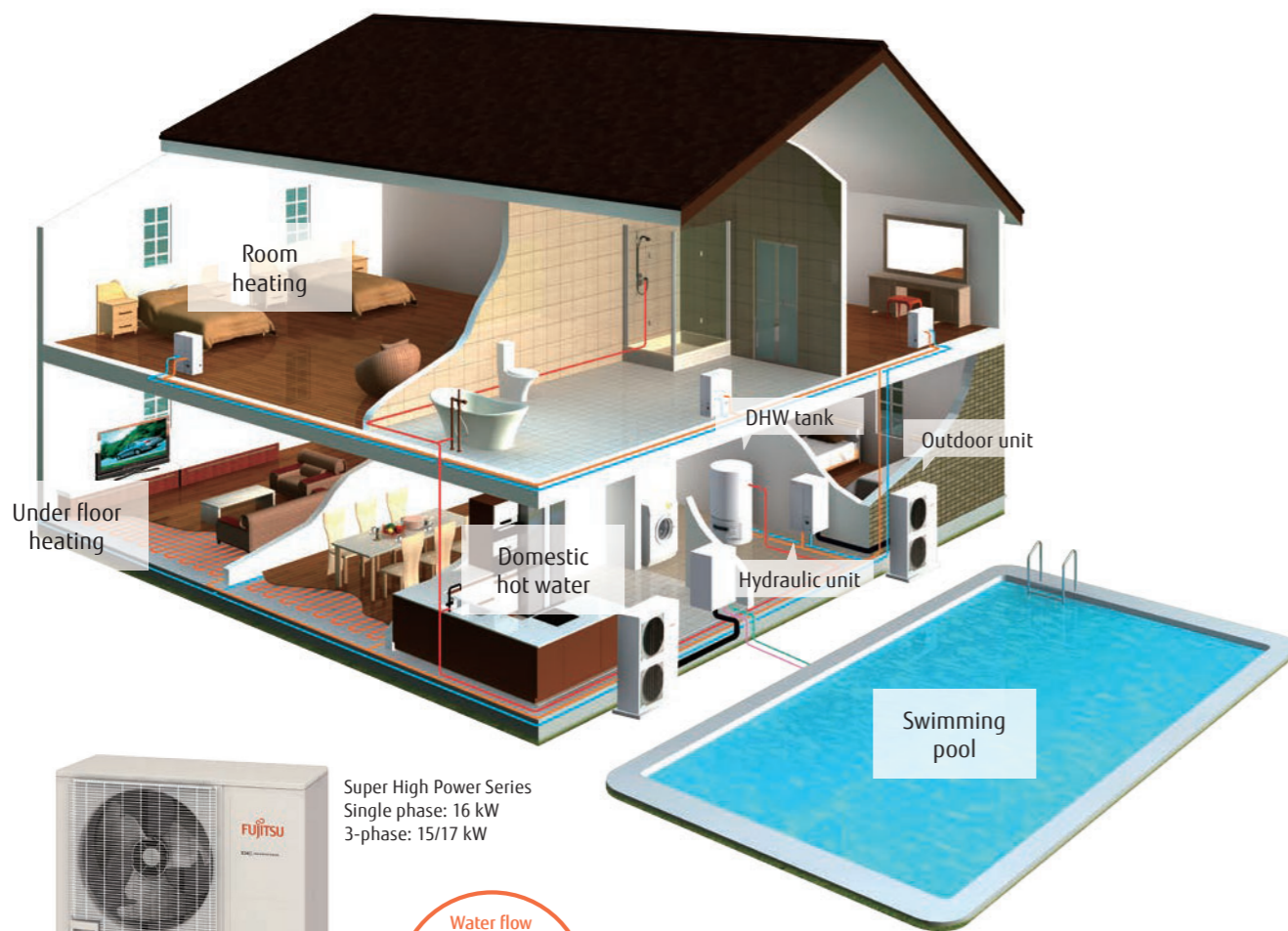

Super High Power Series
Single phase: 16 kW
3-phase: 15/17 kW

Water flow temperature
60°C

High water flow temperature

The temperature of water flow can be maintained at 60°C without using a backup heater, even when the outdoor temperature drops to -20°C.

Floor heating and domestic hot water supply

Outdoor units and hydraulic indoor units can be installed flexibly and easily. Hydraulic units installed inside the house prevent the circulating water from freezing. More units can be cascaded together to provide a greater heating capacity with greater flexibility.¹

¹: High Power Series only

* When using the Swimming pool kit (UTW-KSPXD), other devices (Radiator, DHW tank etc.) cannot be connected in the same system.



NEW



Adopting R32 refrigerant

R32 refrigerant is an environmentally friendly refrigerant with a significantly lower Global Warming Potential (GWP) than conventional refrigerants.



300 Liters

+ DHW tank

A DHW tank (optional) can be connected to supply hot water.

+ Boiler

By combining with an existing boiler, powerful heating can be achieved even at low outdoor temperature.

*Optional parts required

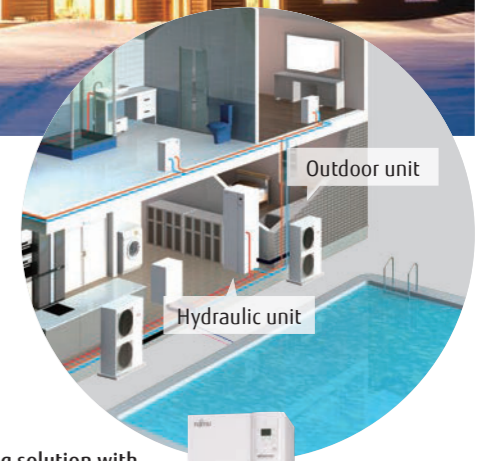

Stylish space saving solution with built-in DHW tank



Built-in DHW tank saves a great deal of space.

Existing boilers can be replaced easily. A higher heating capacity can be achieved with the flexibility to cascade more units.

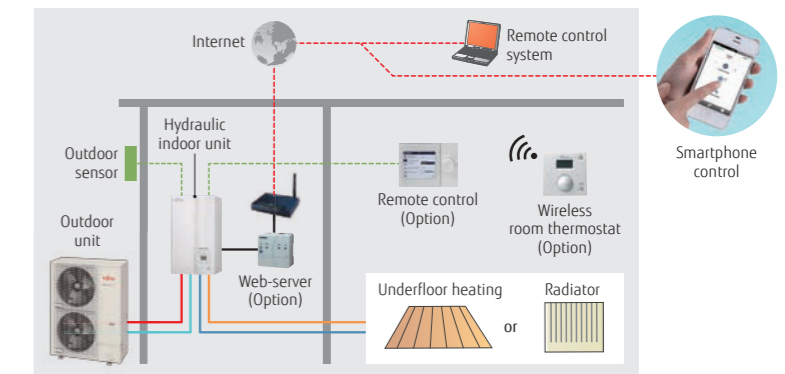

Smart control

To meet the diverse needs of customers, we offer a variety of control options, such as individual control and remote control options.

High-Efficiency Technology

Twin-Rotary Compressor



For Outdoor unit

Twin-Rotary Compressor with Linear Control Injection Port

The compressor achieves a high condensing temperature without overheating the discharge gas temperature due to the Linear control injection process used during compression. This makes the condensing temperature higher than in a normal circuit. Higher water temperatures can be achieved by controlling the injection volume according to usage conditions.

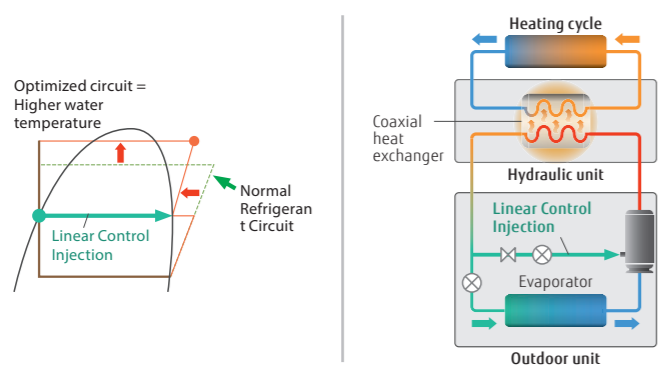

DC inverter technology controls temperatures precisely.

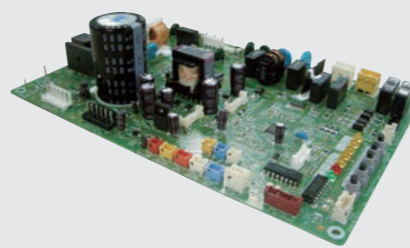
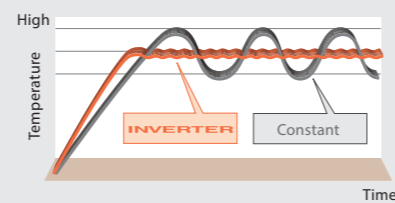

High-durability coaxial heat exchanger

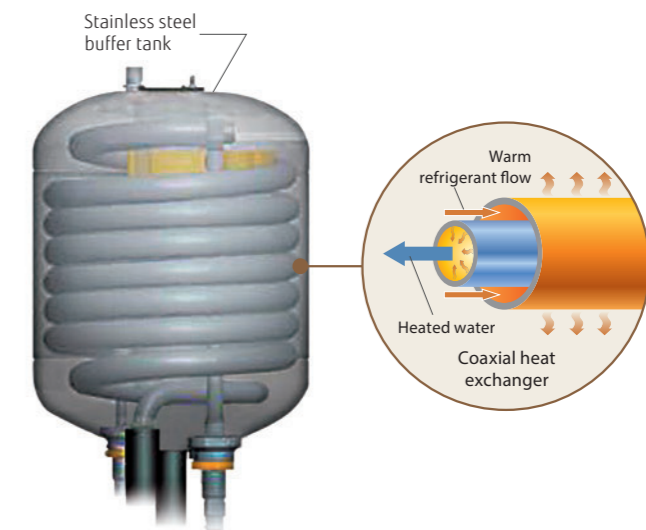

For Hydraulic unit

Stainless steel buffer tank

Heat exchange amount is 25% higher than the previous model. Energy-saving performance has also been improved.

- Anti-corrosion protection
- No flow switch required
- Anti-freeze protection not required

Class A Pump

Energy-saving pump with the ability to adjust the flow rate and pressure to a constant level



Split Type

Comfort Series



High water flow temperature

The temperature of water flow is up to 55°C without a backup heater. Hot water supply temperature can be maintained even at -10°C outdoor temperature.

* If you want to raise the temperature of the water supply to above the maximum temperature, use a backup heater to supplement the primary heater.



High COP

Heat pumps of WATERSTAGE™ ATW Systems work more efficiently and consume less energy than conventional heating systems.

Energy efficiency class **A+++***

*Temperature application: Heating temp. 35°C

Seasonal space heating energy efficiency (η_s)
Conditions: Outdoor Temp. 7°C Heating Temp. 35°C

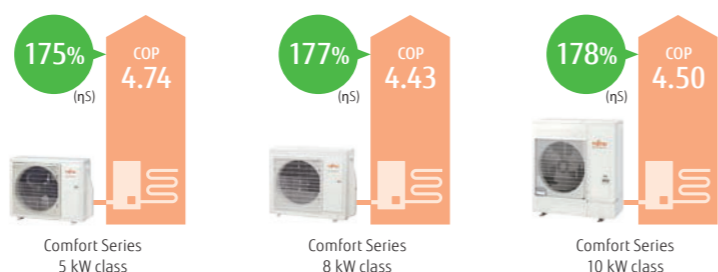

Outdoor unit technology



DC Fan Motor
High-performance, high-efficiency small DC fan motor mounted

DC Twin-Rotary Compressor
High-efficiency DC twin-rotary compressor

DC Inverter
DC inverter provides smooth water temperature control.

Hydraulic unit:
WSYA050ML3/WSYA080ML3/
NEW WSYA100ML3
Outdoor unit:
WOYA060KLT/WOYA080KLT/
NEW WOYA100KLT



Specifications

Model Name	Hydraulic unit	WSYA050ML3	WSYA080ML3	WSYA080ML3	WSYA100ML3				
	Outdoor unit	WOYA060KLT	WOYA060KLT	WOYA080KLT	WOYA100KLT				
Capacity Range		5	6	8	10				
7°C/35°C floor heating *1	Heating capacity	4.50	5.50	7.50	9.50				
	Input power	0.949	1.18	1.69	2.11				
	COP	4.74	4.65	4.43	4.50				
2°C/35°C floor heating *1	Heating capacity	4.50	5.30	6.30	9.30				
	Input power	1.33	1.65	1.96	3.08				
	COP	3.39	3.22	3.21	3.02				
-7°C/35°C floor heating *1	Heating capacity	4.40	5.00	5.70	8.90				
	Input power	1.59	1.90	2.13	3.36				
	COP	2.76	2.63	2.68	2.65				
Space heating characteristics**									
Temperature application	°C	55	35	55	35	55	35	55	35
Energy efficiency class		A++	A++	A++	A+++	A++	A+++	A++	A+++
Rated heat output (P _{rated})	kW	5	5	6	7	8	9	8	9
Seasonal space heating energy efficiency (η_s)	%	125	175	125	175	128	177	130	178
Annual energy consumption	kWh	3,035	2,322	3,411	2,594	3,903	2,982	5,083	3,875
Sound power level*3	Hydraulic unit	40	-	40	-	40	-	40	-
	Outdoor unit	57	-	57	-	60	-	62	-
Hydraulic unit specifications									
Power source		Single phase, ~230 V, 50 Hz							
Dimensions H × W × D	mm	847 × 450 × 493	847 × 450 × 493	847 × 450 × 493	847 × 450 × 493				
Weight (Net)	kg	47	47	47	47				
Water circulation	Min./Max. L/min	7.6/22.0	8.5/22.0	10.0/22.0	13.2/30.0				
Buffer tank capacity	L	16	16	16	16				
Expansion vessel capacity	L	8	8	8	8				
Water flow temperature range	Max. °C	55	55	55	55				
Water pipe connection diameter	Flow/Return mm	Ø25.4/Ø25.4	Ø25.4/Ø25.4	Ø25.4/Ø25.4	Ø25.4/Ø25.4				
Backup heater	Capacity kW	3.0	3.0	3.0	3.0				
Outdoor unit specifications									
Power source		Single phase, ~230 V, 50 Hz							
Current	Max. A	13.0	13.0	18.0	19.0				
Dimensions H × W × D	mm	632 × 799 × 290	632 × 799 × 290	716 × 820 × 315	998 × 940 × 320				
Weight (Net)	kg	39	39	42	62				
Refrigerant	Type (Global Warming Potential)	R32 (675)							
	Charge kg	0.97	0.97	1.02	1.63				
Additional refrigerant charge	g/m	25	25	25	20				
	Liquid mm	6.35	6.35	6.35	9.52				
Connection pipe	Gas mm	12.70	12.70	12.70	15.88				
	Length m	3/30	3/30	3/30	3/30				
	Length (Pre-charge) m	15	15	15	20				
	Height difference Max. m	20	20	20	20				
Operating range	Heating °C	-20 to 35							

*1: Heating capacity, input power, and COP are measured using the EN14511 standard. Actual usage environments, such as the operating modes of the heating equipment, room temperature, and controller settings, may cause differences in values between those listed in the catalog and the actual performance characteristics.

*2: Information about EPR can be downloaded from our website at www.fujitsu-general.com/global/support/downloads/search/

*3: The sound power level values are based on EN12102 standard measurements under EN14825 standard conditions.

Dimensions

(Unit: mm)

Outdoor unit:
WOYA060KLT

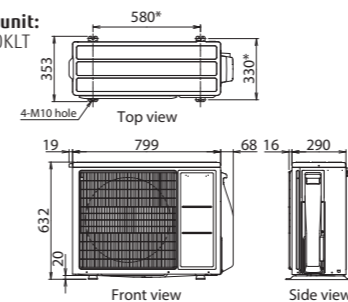

WOYA080KLT

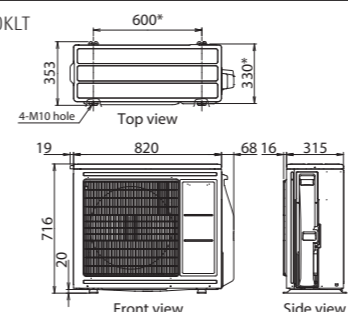

WOYA100KLT

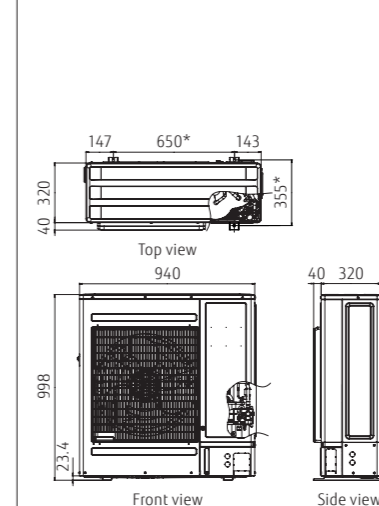

Hydraulic unit:
WSYA050ML3/WSYA080ML3/WSYA100ML3

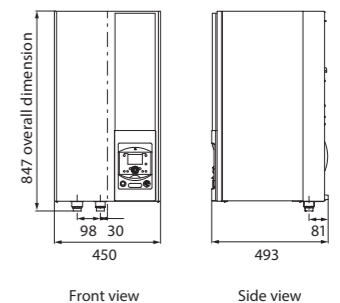

*Pitch of bolts for installation

Split Type

Super High Power Series



High water flow temperature

The temperature of water flow can be maintained at 60°C without using a backup heater, even when the outdoor temperature drops to -20°C. The system can supply 55°C water without a backup heater at an outdoor temperature of -22°C.

* If you want to raise the temperature of the water supply to above the maximum temperature, use a backup heater to supplement the primary heater.

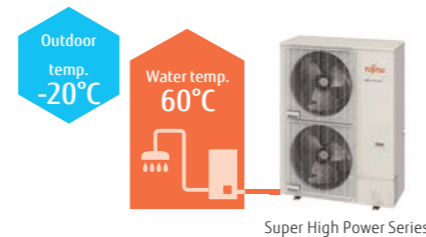

High COP

Heat pumps of WATERSTAGE™ ATW Systems work more efficiently and consume less energy than conventional heating systems.

Energy efficiency class



Seasonal space heating energy efficiency (η_s)

Conditions: Outdoor Temp. 7°C Heating Temp. 35°C

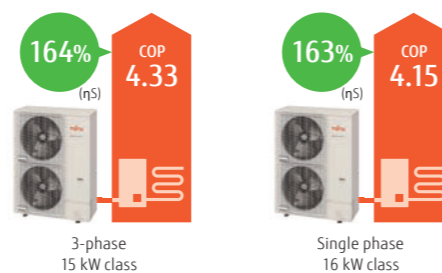

Operating range extended to -25°C

Operating range improved down to -25°C outdoor temperature



Hydraulic unit:
WSYG160DJ6/[3-phase] WSYK170DJ9
Outdoor unit:
WOYG160LJL
[3-phase] WOYK150LJL/WOYK170LJL



Hydraulic unit
Single phase/
3-phase



Outdoor unit
Single phase 16 kW
3-phase 15/17 kW

Specifications

Model Name	Hydraulic unit	Outdoor unit	WSYG160DJ6 WOYG160LJL	WSYK170DJ9 WOYK150LJL	WSYK170DJ9 WOYK170LJL	
Capacity range			16	15	17	
7°C/35°C floor heating *1	Heating capacity	kW	16.00	15.00	17.00	
	Input power		3.86	3.46	4.10	
	COP		4.15	4.33	4.15	
2°C/35°C floor heating *1	Heating capacity	kW	13.30	13.20	13.50	
	Input power		4.25	4.06	4.27	
	COP		3.13	3.25	3.16	
-7°C/35°C floor heating*1	Heating capacity	kW	14.50	13.20	15.00	
	Input power		5.27	4.55	5.32	
	COP		2.75	2.90	2.82	
Space heating characteristics*2						
Temperature application	°C		55	35	55	35
Energy efficiency class			A++	A++	A++	A++
Rated heat output (P _{rated})	kW		14	16	16	17
Seasonal space heating energy efficiency (η _s)	%		125	163	130	164
Annual energy consumption	kWh		8,757	8,014	9,915	8,606
Sound power level	Hydraulic unit	dB(A)	45	45	45	45
	Outdoor unit		67	66	67	66
Hydraulic unit specifications						
Power source			Single phase, ~230 V, 50 Hz		3-phase, ~400 V, 50 Hz	
Dimensions H × W × D	mm		805 × 450 × 471		805 × 450 × 471	
Weight (Net)	kg		52.5		52.5	
Water circulation	Min./Max.	L/min	26.4/57.8		24.0/54.2	
Buffer tank capacity		L	22		22	
Expansion vessel capacity		L	10		10	
Water flow temperature range	Max.	°C	60		60	
Water pipe connection diameter	Flow/Return	mm	Ø25.4/Ø25.4		Ø25.4/Ø25.4	
	Capacity	kW	6.0 (3.0 kW × 2 pcs.)		9.0 (3.0 kW × 3 pcs.)	
Outdoor unit specifications						
Power source			Single phase, ~230 V, 50 Hz		3-phase, ~400 V, 50 Hz	
Current	Max.	A	28.0		14.0	
Dimensions H × W × D	mm		1,428 × 1,080 × 480		1,428 × 1,080 × 480	
Weight (Net)	kg		137		138	
Refrigerant	Type (Global Warming Potential)		R410A (2,088)			
	Charge	kg	3.80		3.80	
Additional refrigerant charge		g/m	50		50	
	Diameter	Liquid	mm	Ø9.52		
Connection pipe	Gas	mm	Ø15.88			
	Length	Min./Max.	m	5/30		
	Length (Pre-charge)	m	15			
Height difference	Max.	m	25/15 (Outdoor unit: Upper/Lower)			
		°C	-25 to 35		-25 to 35	

*1: Heating capacity, input power, and COP are measured using the EN14511 standard. Actual usage environments, such as the operating modes of the heating equipment, room temperature, and controller settings, may cause differences in values between those listed in the catalog and the actual performance characteristics.

*2: Information about ErP can be downloaded from our website at www.fujitsu-general.com/global/support/downloads/search/

Dimensions

(Unit: mm)

Outdoor unit:
Single phase: WOYG160LJL
3-phase: WOYK150LJL/WOYK170LJL

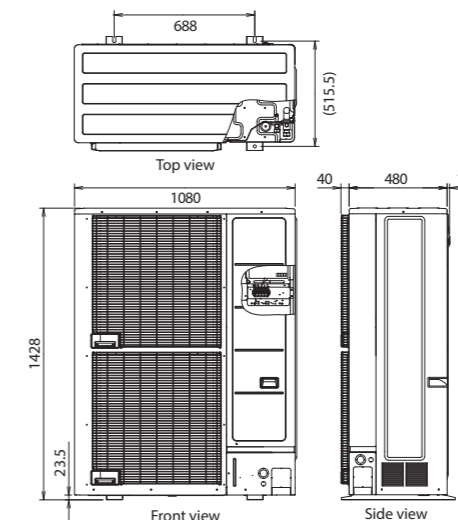

Hydraulic unit:
Single phase: WSYG160DJ6
3-phase: WSYK170DJ9

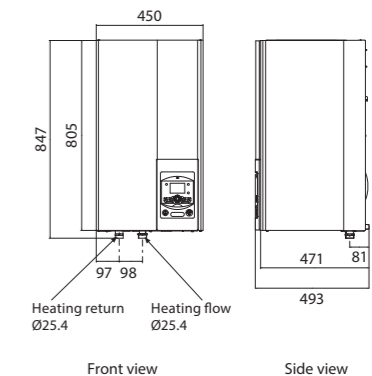

Split Type High Power Series



High water flow temperature

The temperature of water flow can be maintained at 60°C without using a backup heater, even when the outdoor temperature drops to -20°C.

* If you want to raise the temperature of the water supply to above the maximum temperature, use a backup heater to supplement the primary heater.



High COP

Heat pumps of WATERSTAGE™ ATW Systems work more efficiently and consume less energy than conventional heating systems.

Energy efficiency class



*Temperature application: Heating temp. 35°C

Seasonal space heating energy efficiency (η_s)

Conditions: Outdoor Temp. 7°C Heating Temp. 35°C

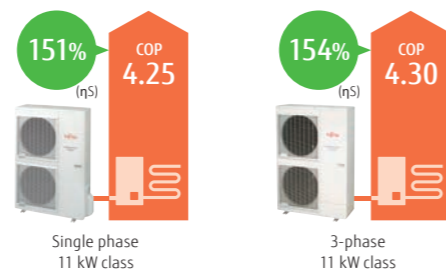

Hydraulic unit:
WSYG140DG6/[3-phase] WSYK160DG9
Outdoor unit:
WOYG112LHT/WOYG140LCTA
[3-phase] WOYK112LCTA/WOYK140LCTA/
WOYK160LCTA



Hydraulic unit
Single phase/
3-phase



Outdoor unit
Single phase
11/14 kW



Outdoor unit
3-phase
11/14/16 kW

Specifications

Model Name	Hydraulic unit		WSYG140DG6		WSYG140DG6		WSYK160DG9		WSYK160DG9		WSYK160DG9	
	Outdoor unit		WOYG112LHT		WOYG140LCTA		WOYK112LCTA		WOYK140LCTA		WOYK160LCTA	
Capacity range			11		14		11		14		16	
7°C/35°C floor heating *1	Heating capacity	kW	10.80		13.50		10.80		13.50		15.17	
	Input power		2.54		3.23		2.51		3.20		3.70	
	COP		4.25		4.18		4.30		4.22		4.10	
2°C/35°C floor heating *1	Heating capacity	kW	10.77		12.00		10.77		13.00		13.50	
	Input power		3.44		3.87		3.40		4.15		4.34	
	COP		3.13		3.10		3.17		3.13		3.11	
-7°C/35°C floor heating *1	Heating capacity	kW	10.38		11.54		10.38		12.20		13.50	
	Input power		4.32		5.08		4.28		5.13		5.40	
	COP		2.40		2.27		2.43		2.38		2.50	

Space heating characteristics*2

Temperature application	°C	55	35	55	35	55	35	55	35	55	35
Energy efficiency class		A+	A++	A+	A+	A+	A++	A+	A++	A+	A+
Rated heat output (P _{rated})	kW	9	11	11	13	9	11	11	13	13	14
Seasonal space heating energy efficiency (η _s)	%	112	151	113	148	112	154	117	150	117	149
Annual energy consumption	kWh	6,704	6,062	8,041	6,824	6,669	5,930	7,803	6,738	9,062	7,408
Sound power level	Hydraulic unit	46		46		46		46		46	
	Outdoor unit	68		69		69		68		71	

Hydraulic unit specifications

Power source	Single phase, ~230 V, 50 Hz				3-phase, ~400 V, 50 Hz					
Dimensions H × W × D	800 × 450 × 457				800 × 450 × 457					
Weight (Net)	42				42					
Water circulation	Min./Max.	L/min	19.5/39.0	24.4/48.7	19.5/39.0	24.4/48.7	27.4/54.8			
Buffer tank capacity	16				16					
Expansion vessel capacity	8				8					
Water flow temperature range	Max.	°C	60				60			
Water pipe connection diameter	Flow/Return	mm	Ø25.4/Ø25.4				Ø25.4/Ø25.4			
Backup heater	Capacity	kW	6.0 (3.0 kW × 2 pcs.)				9.0 (3.0 kW × 3 pcs.)			

Outdoor unit specifications

Power source	Single phase, ~230 V, 50 Hz				3-phase, ~400 V, 50 Hz					
Current	Max.	A	22.0	25.0	9.0	9.5	10.5			
Dimensions H × W × D	92				1,290 × 900 × 330					
Weight (Net)	92				99					
Refrigerant	Type (Global Warming Potential)	R410A (2,088)								
	Charge	kg	2.50							
Additional refrigerant charge		g/m	50							
	Diameter	Liquid	Ø9.52							
Connection pipe	Gas	mm	Ø15.88							
	Length	Min./Max.	5/20							
	Length (Pre-charge)	m	15							
	Height difference	Max.	15							
Operating range	Heating	°C	-25 to 35							

*1: Heating capacity, input power, and COP are measured using the EN14511 standard. Actual usage environments, such as the operating modes of the heating equipment, room temperature, and controller settings, may cause differences in values between those listed in the catalog and the actual performance characteristics.

*2: Information about ErP can be downloaded from our website at www.fujitsu-general.com/global/support/downloads/search/

Dimensions

(Unit: mm)

Outdoor unit:

Single phase: WOYG112LHT/WOYG140LCTA

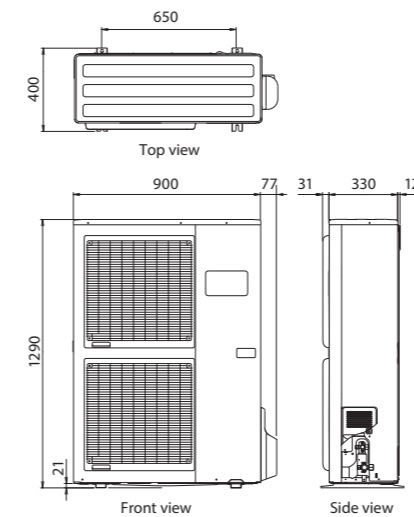

3-phase: WOYK112LCTA/WOYK140LCTA/WOYK160LCTA

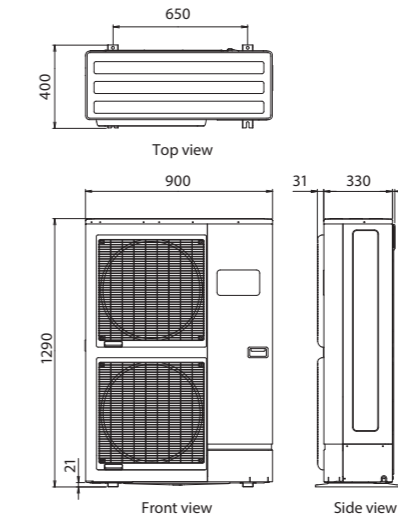

Hydraulic unit:

Single phase: WSYG140DG6
3-phase: WSYK160DG9

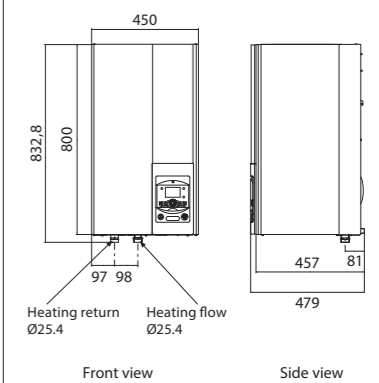

Split DHW Integrated Type

Comfort Series



High water flow temperature

The temperature of water flow is up to 55°C without a backup heater. Hot water supply temperature can be maintained even at -10°C outdoor temperature.

* If you want to raise the temperature of the water supply to above the maximum temperature, use a backup heater to supplement the primary heater.



High COP

Heat pumps of WATERSTAGE™ ATW Systems work more efficiently and consume less energy than conventional heating systems.

Energy efficiency class



*Temperature application: Heating temp. 35°C

Seasonal space heating energy efficiency (η_s)

Conditions: Outdoor Temp. 7°C Heating Temp. 35°C

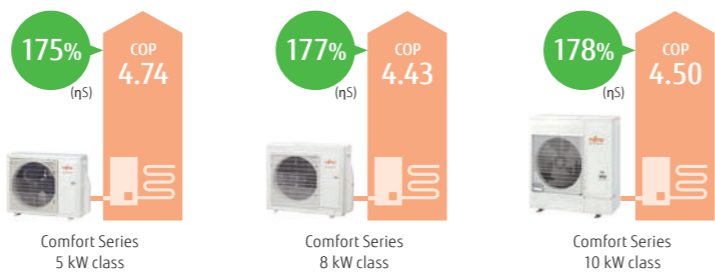

Outdoor unit technology



DC Fan Motor
High-performance, high-efficiency small DC fan motor mounted

DC Twin-Rotary Compressor
High-efficiency DC twin-rotary compressor

DC Inverter
DC inverter provides smooth water temperature control.

Hydraulic unit:
WGYA050ML3/WGYA080ML3/
NEW WGYA100ML3
Outdoor unit:
WOYA060KLT/WOYA080KLT/
NEW WOYA100KLT

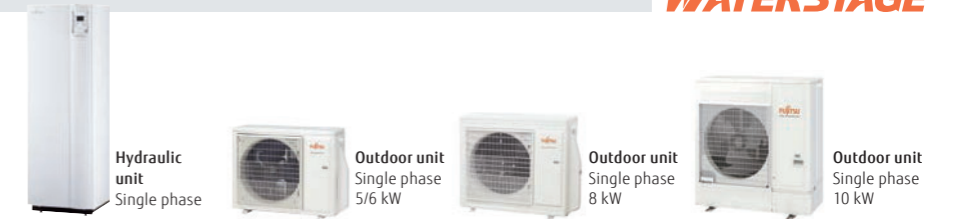

Specifications

Model Name	Hydraulic unit	WGYA050ML3	WGYA080ML3	WGYA080ML3	WGYA100ML3				
	Outdoor unit	WOYA060KLT	WOYA060KLT	WOYA080KLT	WOYA100KLT				
Capacity range		5	6	8	10				
7°C/35°C floor heating *1	Heating capacity	4.50	5.50	7.50	9.50				
	Input power	0.949	1.18	1.69	2.11				
	COP	4.74	4.65	4.43	4.50				
2°C/35°C floor heating *1	Heating capacity	4.50	5.30	6.30	9.30				
	Input power	1.33	1.65	1.96	3.08				
	COP	3.39	3.22	3.21	3.02				
-7°C/35°C floor heating *1	Heating capacity	4.40	5.00	5.70	8.90				
	Input power	1.59	1.90	2.13	3.36				
	COP	2.76	2.63	2.68	2.65				
Space heating characteristics*2									
Temperature application	°C	55	35	55	35	55	35	55	35
Energy efficiency class		A++	A+++	A++	A+++	A++	A+++	A++	A+++
Rated heat output (P _{rated})	kW	5	5	5	6	6	7	8	9
Seasonal space heating energy efficiency (η _s)	%	125	175	125	175	128	177	130	178
Annual energy consumption	kWh	3,035	2,322	3,411	2,594	3,903	2,982	5,083	3,875
Sound power level*3	Hydraulic unit								
	Outdoor unit	dB(A)	40	-	40	-	40	-	40
Domestic hot water characteristics*2									
Load profile		L	L	L	L				
Energy efficiency class		A+	A+	A+	A+				
Energy efficiency (η _{wh})	%	130	130	130	130				
Annual electricity consumption	kWh	793	793	793	793				
Hydraulic unit specifications									
Power source		Single phase, ~230 V, 50 Hz							
Dimensions H × W × D	mm	1,863 × 648 × 700	1,863 × 648 × 700	1,863 × 648 × 700	1,863 × 648 × 700				
Weight (Net)	kg	145	145	145	145				
Water circulation	Min./Max.	L/min	7.6/22.0	8.5/22.0	10.0/22.0	13.2/30.0			
DHW capacity	L	190	190	190	190				
Hot water heater capacity	kW	1.5	1.5	1.5	1.5				
Buffer tank capacity	L	16	16	16	16				
Expansion vessel capacity	L	8	8	8	8				
Water flow temperature range	Max.	°C	55	55	55				
Water pipe connection diameter	Flow/Return	mm	Ø25.4/Ø25.4	Ø25.4/Ø25.4	Ø25.4/Ø25.4				
Hot water pipe connection diameter		mm	Ø19.05	Ø19.05	Ø19.05				
Backup heater	Capacity	kW	3.0	3.0	3.0				
Outdoor unit specifications									
Power source		Single phase, ~230 V, 50 Hz							
Current	Max.	A	13.0	13.0	18.0	19.0			
Dimensions H × W × D	mm	632 × 799 × 290	632 × 799 × 290	716 × 820 × 315	998 × 940 × 320				
Weight (Net)	kg	39	39	42	62				
Refrigerant	Type (Global Warming Potential)	R32 (675)							
Charge	kg	0.97	0.97	1.02	1.63				
Additional refrigerant charge	g/m	25	25	25	20				
Connection pipe	Diameter	Liquid	6.35	6.35	6.35	9.52			
		Gas	12.70	12.70	12.70	15.88			
	Length	Min./Max.	m	3/30	3/30	3/30			
	Length (Pre-charge)	m	15	15	15	20			
Height difference	Max.	m	20	20	20				
	Heating	°C	-20 to 35	-20 to 35	-20 to 35	-20 to 35			

*1: Heating capacity, input power, and COP are measured using the EN14511 standard. Actual usage environments, such as the operating modes of the heating equipment, room temperature, and controller settings, may cause differences in values between those listed in the catalog and the actual performance characteristics.

*2: Information about EIP can be downloaded from our website at www.fujitsu-general.com/global/support/downloads/search/

*3: The sound power level values are based on EN12102 standard measurements under EN14825 standard conditions.

Dimensions

(Unit: mm)

Outdoor unit:
WOYA060KLT

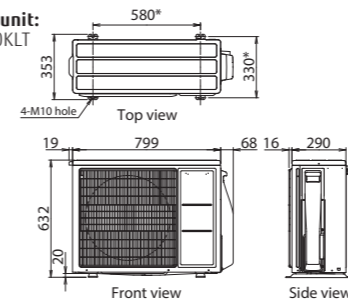

WOYA080KLT

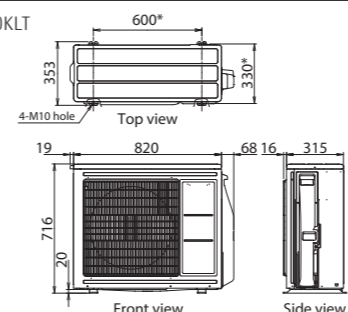

WOYA100KLT

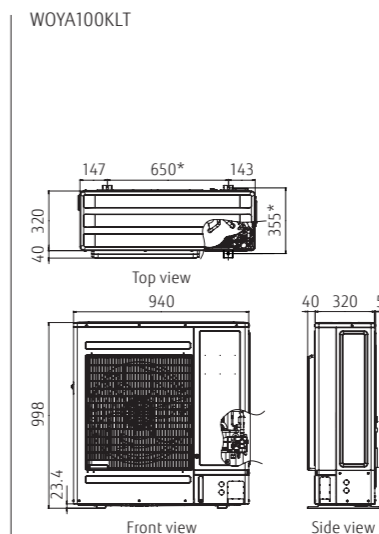

Hydraulic unit:
WGYA050ML3/WGYA080ML3/WGYA100ML3

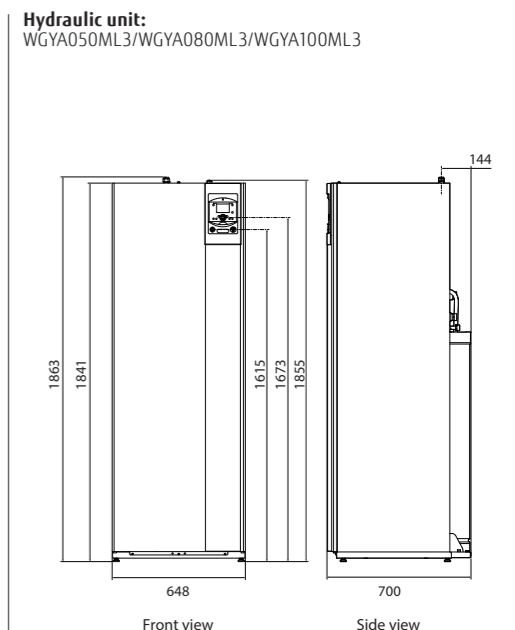

*Pitch of bolts for installation

Split DHW Integrated Type

Super High Power Series



High water flow temperature

The temperature of water flow can be maintained at 60°C without using a backup heater, even when the outdoor temperature drops to -20°C. The system can supply 55°C water without a backup heater at an outdoor temperature of -22°C.

* If you want to raise the temperature of the water supply to above the maximum temperature, use a backup heater to supplement the primary heater.

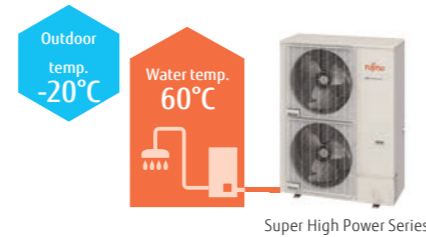

High COP

Heat pumps of WATERSTAGE™ ATW Systems work more efficiently and consume less energy than conventional heating systems.

Energy efficiency class **A++**

Seasonal space heating energy efficiency (η_s)

Conditions: Outdoor Temp. 7°C Heating Temp. 35°C

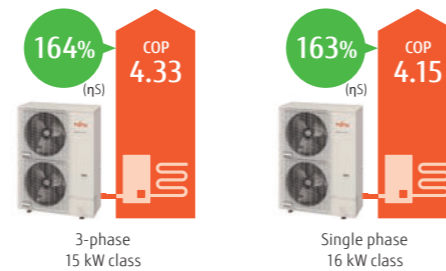

Operating range extended to -25°C

Operating range improved down to -25°C outdoor temperature

Stylish space saving solution with **Built-in High-performance DHW tank 190 L**

- Coil heat exchanger optimizes DHW supply performance.
- Temperature rises quickly due to the large surface of the exchanger.

Hydraulic unit:
WGYG160DJ6 / [3-phase] WGYK170DJ9
Outdoor unit:
WOYG160LJL
[3-phase] WOYK150LJL/WOYK170LJL



Hydraulic unit
Single phase/
3-phase



Outdoor unit
Single phase 16 kW
3-phase 15/17 kW

Specifications

Model Name	Hydraulic unit	WGYG160DJ6	WGYK170DJ9	WGYK170DJ9			
Capacity range	Outdoor unit	WGYG160DJ6	WGYK170DJ9	WGYK170DJ9			
7°C/35°C floor heating *1	Heating capacity	16.00	15.00	17.00			
	Input power	3.86	3.46	4.10			
	COP	4.15	4.33	4.15			
2°C/35°C floor heating *1	Heating capacity	13.30	13.20	13.50			
	Input power	4.25	4.06	4.27			
	COP	3.13	3.25	3.16			
-7°C/35°C floor heating*1	Heating capacity	14.50	13.20	15.00			
	Input power	5.27	4.55	5.32			
	COP	2.75	2.90	2.82			
Space heating characteristics*2							
Temperature application	°C	55	35	55	35	55	35
Energy efficiency class		A++	A++	A++	A++	A++	A++
Rated heat output (P _{rated})	kW	14	16	16	17	17	18
Seasonal space heating energy efficiency (η _s)	%	125	163	130	164	130	161
Annual energy consumption	kWh	8,757	8,014	9,915	8,606	10,232	9,059
Sound power level	Hydraulic unit	45	45	45	45	45	45
	Outdoor unit	67	66	67	66	67	68
Domestic hot water characteristics*2							
Load profile							L
Energy efficiency class							A
Energy efficiency (η _{wh})	%						109
Annual electricity consumption	kWh						941
Hydraulic unit specifications							
Power source		Single phase, ~230 V, 50 Hz		3-phase, ~400 V, 50 Hz			
Dimensions H × W × D	mm	1,841 × 648 × 698		1,841 × 648 × 698			
Weight (Net)	kg	166		166			
Water circulation	Min./Max. L/min	26.4/57.8		24.0/54.2			
DHW capacity	L	190		190			
Hot water heater capacity	kW	1.5		1.5			
Buffer tank capacity	L	22		22			
Expansion vessel capacity	L	12		12			
Water flow temperature range	Max. °C	60		60			
Water pipe connection diameter	Flow/Return mm	Ø25.4/Ø25.4		Ø25.4/Ø25.4			
Hot water pipe connection diameter	mm	Ø19.05		Ø19.05			
Backup heater	Capacity kW	6.0 (3.0 kW × 2 pcs.)		9.0 (3.0 kW × 3 pcs.)			
Outdoor unit specifications							
Power source		Single phase, ~230 V, 50 Hz		3-phase, ~400 V, 50 Hz			
Current	Max. A	28.0		14.0			
Dimensions H × W × D	mm	1,428 × 1,080 × 480		1,428 × 1,080 × 480			
Weight (Net)	kg	137		138			
Refrigerant	Type (Global Warming Potential)	R410A (2,088)		R410A (2,088)			
Additional refrigerant charge	Charge	3.80		3.80			
	g/m	50		50			
Connection pipe	Diameter	Liquid	Ø9.52		Ø9.52		
		Gas	Ø15.88		Ø15.88		
	Length	Min./Max.	5/30		5/30		
		Length (Pre-charge)	15		15		
Height difference	Max.	25/15 (Outdoor unit: Upper/Lower)		25/15 (Outdoor unit: Upper/Lower)			
	Heating	°C		-25 to 35			

*1: Heating capacity, input power, and COP are measured using the EN14511 standard. Actual usage environments, such as the operating modes of the heating equipment, room temperature, and controller settings, may cause differences in values between those listed in the catalog and the actual performance characteristics.

*2: Information about ErP can be downloaded from our website at www.fujitsu-general.com/global/support/downloads/search/

Dimensions

(Unit: mm)

Outdoor unit:
Single phase: WOYG160LJL
3-phase: WOYK150LJL/WOYK170LJL

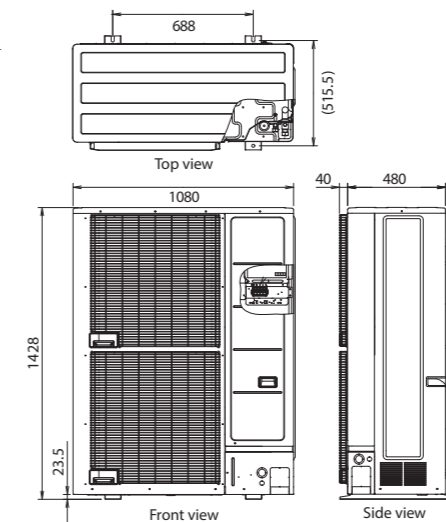

Hydraulic unit:
Single phase: WGYG160DJ6
3-phase: WGYK170DJ9

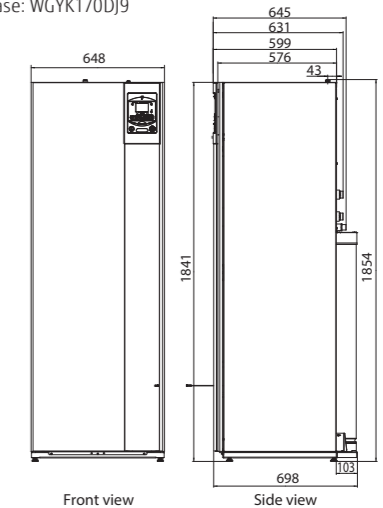

Split DHW Integrated Type

High Power Series



High water flow temperature

The temperature of water flow can be maintained at 60°C without using a backup heater, even when the outdoor temperature drops to -20°C.

* If you want to raise the temperature of the water supply to above the maximum temperature, use a backup heater to supplement the primary heater.



High COP

Heat pumps of WATERSTAGE™ ATW Systems work more efficiently and consume less energy than conventional heating systems.



*Temperature application: Heating temp. 35°C

Seasonal space heating energy efficiency (η_s)

Conditions: Outdoor Temp. 7°C Heating Temp. 35°C

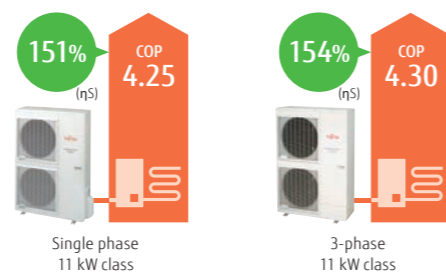

Optimized refrigerant cycle operation

The High Power Series deliver high performance and efficiency with twin sensors and hot water heating technology.

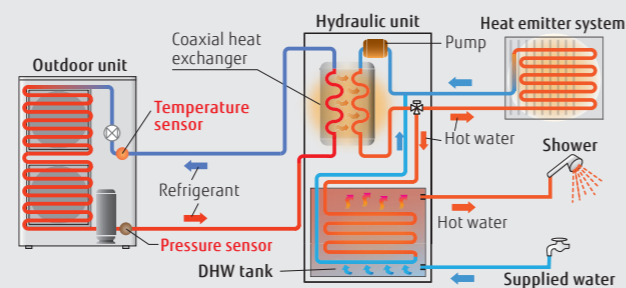

Hydraulic unit:
WGYG140DG6/[3-phase] WGYK160DG9
Outdoor unit:
WOYG112LHT/WOYG140LCTA
[3-phase] WOYK112LCTA/WOYK140LCTA/
WOYK160LCTA



Hydraulic unit
Single phase/
3-phase



Outdoor unit
Single phase
11/14 kW



Outdoor unit
3-phase
11/14/16 kW

Specifications

Model Name	Hydraulic unit		WGYG140DG6		WGYK160DG9		WGYG140DG6		WGYK160DG9	
	Outdoor unit		WOYG112LHT	WOYG140LCTA	WOYK112LCTA	WOYK140LCTA	WOYK112LCTA	WOYK140LCTA	WOYK160DG9	WOYK160LCTA
Capacity range			11	14	11	14	11	14	16	
7°C/35°C floor heating *1	Heating capacity	kW	10.80	13.50	10.80	13.50	10.80	13.50	15.17	
	Input power		2.54	3.23	2.51	3.20	2.51	3.20	3.70	
	COP		4.25	4.18	4.30	4.22	4.30	4.22	4.10	
2°C/35°C floor heating *1	Heating capacity	kW	10.77	12.00	10.77	12.00	10.77	12.00	13.50	
	Input power		3.44	3.87	3.40	4.15	3.40	4.15	4.34	
	COP		3.13	3.10	3.17	3.13	3.17	3.13	3.11	
-7°C/35°C floor heating *1	Heating capacity	kW	10.38	11.54	10.38	12.20	10.38	12.20	13.50	
	Input power		4.32	5.08	4.28	5.13	4.28	5.13	5.40	
	COP		2.40	2.27	2.43	2.38	2.43	2.38	2.50	

Space heating characteristics*2

Temperature application	°C	55	35	55	35	55	35	55	35	55	35
Energy efficiency class		A+	A++	A+	A+	A+	A++	A+	A++	A+	A+
Rated heat output (P _{rated})	kW	9	11	11	13	9	11	11	13	13	14
Seasonal space heating energy efficiency (η _s)	%	112	151	113	148	112	154	117	150	117	149
Annual energy consumption	kWh	6,704	6,062	8,041	6,824	6,669	5,930	7,803	6,738	9,062	7,408
Sound power level	Hydraulic unit										
	Outdoor unit	dB(A)	46	46	46	46	46	46	46	46	46
		68	68	69	69	69	68	70	68	71	71

Domestic hot water characteristics*2

Load profile		L									
Energy efficiency class		A									
Energy efficiency (η _{wh})	%	88									
Annual electricity consumption	kWh	1166									

Hydraulic unit specifications

Power source	Single phase, ~230 V, 50 Hz				3-phase, ~400 V, 50 Hz					
Dimensions H × W × D	mm				1,840 × 648 × 698					
Weight (Net)	kg				152					
Water circulation	Min./Max.	L/min	19.5/39.0	24.4/28.7	19.5/39.0	24.4/48.7	27.4/54.8			
DHW capacity		L	190							
Hot water heater capacity		kW	1.5							
Buffer tank capacity		L	16							
Expansion vessel capacity		L	12							
Water flow temperature range	Max.	°C	60							
Water pipe connection diameter	Flow/Return	mm	Ø25.4/Ø25.4							
Hot water pipe connection diameter		mm	Ø19.05							
Backup heater	Capacity	kW	6.0 (3.0 kW × 2 pcs.)				9.0 (3.0 kW × 3 pcs.)			

Outdoor unit specifications

Power source	Single phase, ~230 V, 50 Hz				3-phase, ~400 V, 50 Hz				
Current	Max.	A	22.0	25.0	9.0	9.5	10.5		
Dimensions H × W × D	mm				1,290 × 900 × 330				
Weight (Net)	kg				92				
Refrigerant	Type (Global Warming Potential)	R410A (2,088)							
	Charge	kg	2.50						
Additional refrigerant charge		g/m	50						
	Diameter	Liquid	Ø9.52						
Connection pipe		Gas	Ø15.88						
	Length	Min./Max.	m						
	Length (Pre-charge)		m						
	Height difference	Max.	m						
Operating range		°C	-25 to 35						
	Heating								

*1: Heating capacity, input power, and COP are measured using the EN14511 standard. Actual usage environments, such as the operating modes of the heating equipment, room temperature, and controller settings, may cause differences in values between those listed in the catalog and the actual performance characteristics.

*2: Information about ErP can be downloaded from our website at www.fujitsu-general.com/global/support/downloads/search/

Dimensions

(Unit: mm)

Outdoor unit:

Single phase: WGYG112LHT/WOYG140LCTA

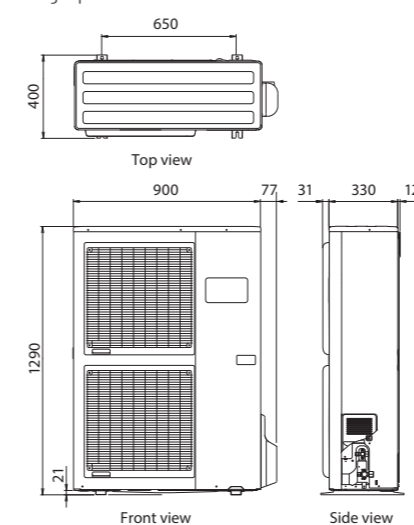

3-phase: WOYK112LCTA/WOYK140LCTA/WOYK160LCTA

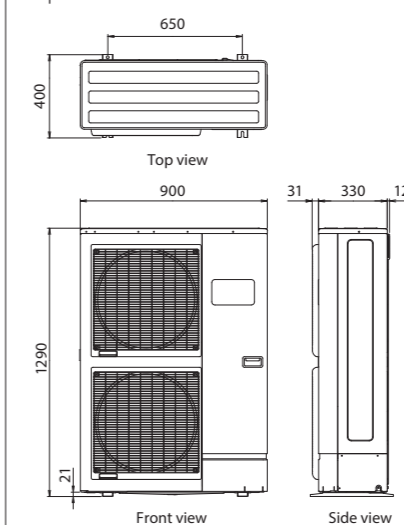

Hydraulic unit:

Single phase: WGYG140DG6
3-phase: WGYK160DG9

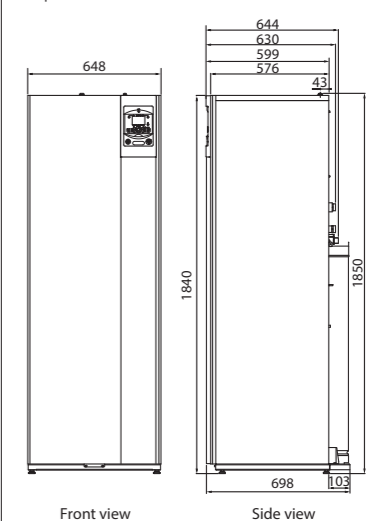

Control Overview

To meet the diverse needs of customers, we offer a variety of control options, such as individual control and remote control options.

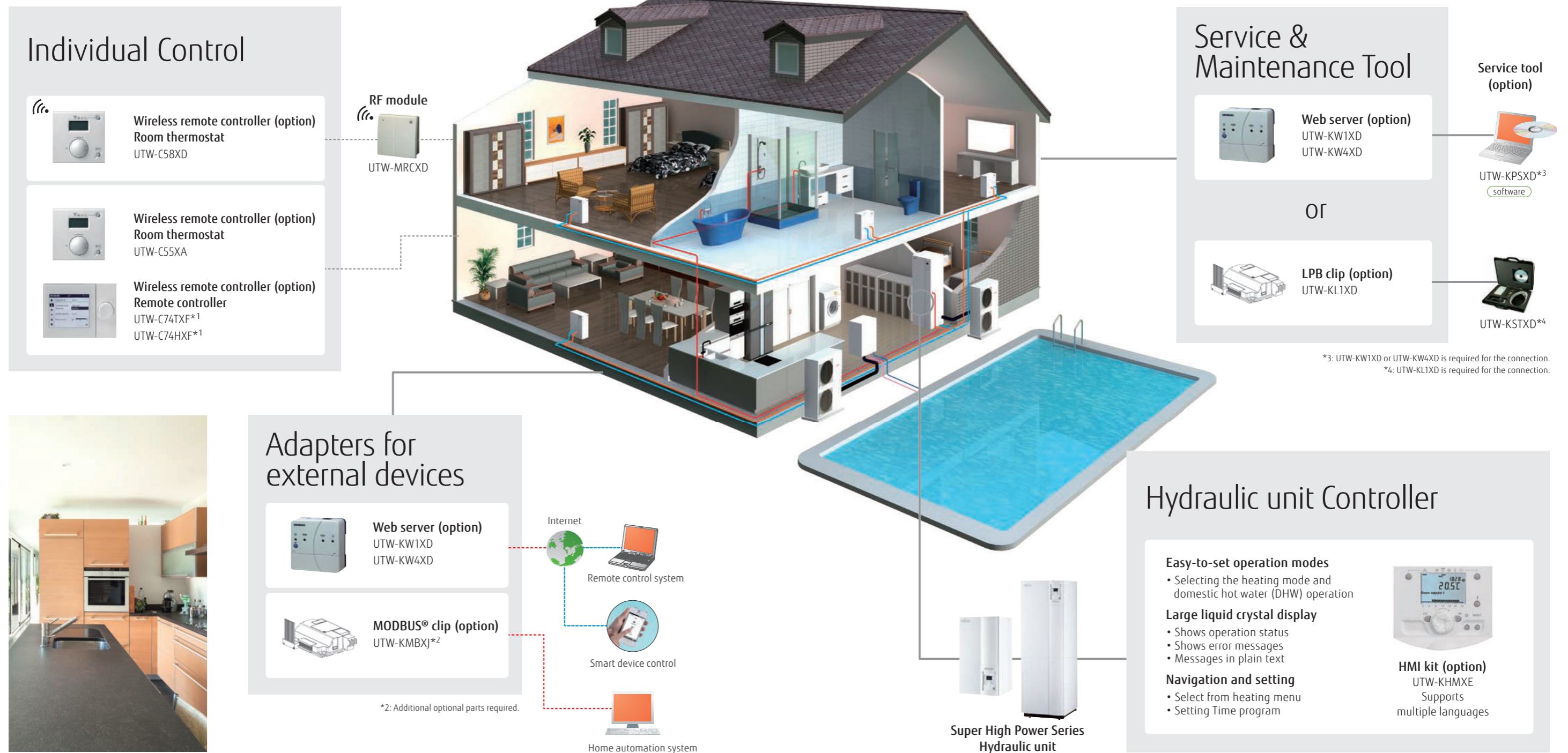

Comfort Control

The high-grade heating controller automatically adjusts the flow temperature according to the climate conditions to maintain the room and domestic hot water temperatures at the desired levels.

Hydraulic unit Controller 4 Heating modes

- 1. Automatic mode**
Enables automatic switching between Comfort mode and Reduce mode according to time program
- 2. Reduce mode**
Maintains water temperature at a lower level
- 3. Comfort mode**
Maintains water temperature at a comfortable level
- 4. Protection mode**
Activates frost protection in standby operation



Useful Features

Automatic heating curve control

Automatic temperature regulation according to heating curve (depending on heating terminal and outdoor temperature)

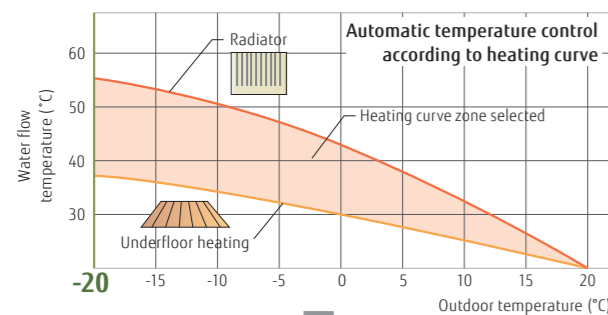

The heating curve will shift to adjust the room temperature setting.

Can be fine-adjusted when it is too warm or too cold.

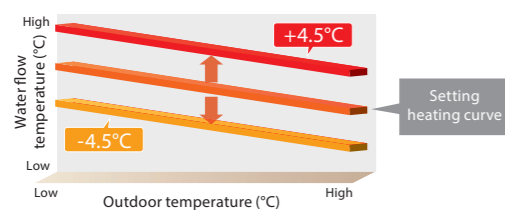

Quick recovery from defrosting

Maintains room temperature by boost start operation during defrosting.

Auto changeover

When cooling mode is selected, the system automatically switches between cooling and heating modes depending on the outdoor temperature to serve as an all-season air conditioner.

2-zone independent control

2-zone independent control (For example, the individual control of 2 underfloor heating zones or the combination of 1 underfloor heating zone and 1 radiator zone)*1

*1: Optional parts required

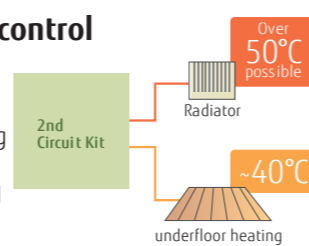

2-stage low-noise mode

The outdoor unit can be switched to quiet mode, depending on the installation environment.

*Effective only for High Power Series

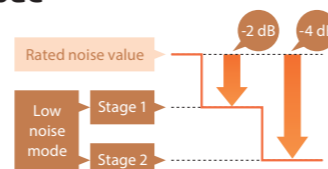

Backup heater operation

Backup heater maintains a comfortable room temperature even when the outside temperature is low. The backup heater is intelligently controlled as a safety backup for very cold days and nights, and only operates when really needed.

Energy Saving

Time program

- The timer is easy to set.
- You can select the heating mode in conjunction with various times of the day.

Day-weekly timer

- Allows up to 3 settings per day.
- Allows individual settings for each day of the week.

Holiday timer

- Allows up to 8 settings.
- While you are away from home for an extended period during winter, the system prevents your room or house from freezing.

Peak cut Function*2

Sets the peak current value to reduce power consumption.

Mode	Ratio to reduce power consumption
1	100%
2	75%
3	50%
4	Almost 0%

*2: Optional parts required

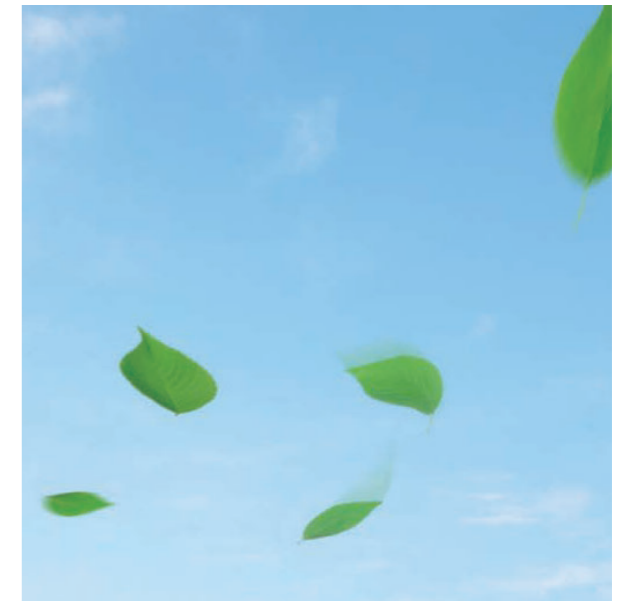

Safety Features

Anti-Legionella function

Prevents the growth of Legionella bacteria in the DHW tank to supply safe and clean hot water at all times.



Anti-freeze function

When the outside temperature drops below a specified level, the compressor will self-activate and water will also be automatically circulated to prevent freezing.

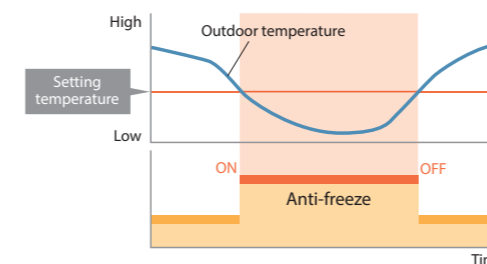

Emergency operation

If an outdoor unit fails to operate, a built-in backup heater or an external boiler is activated to supply an uninterrupted supply of hot water to the house.

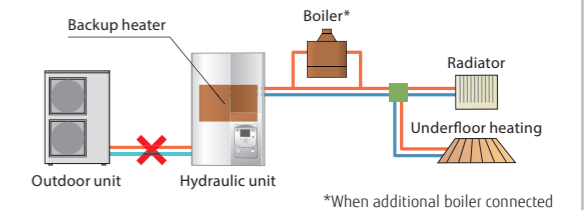

Error and Maintenance Alarm

Enables quick error-handling services and maintenance



- Error history saves 10 errors in memory
- Display telephone number of service company

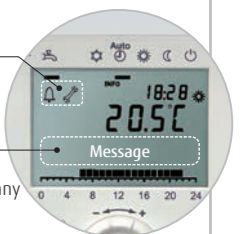

System Configuration

Split Type

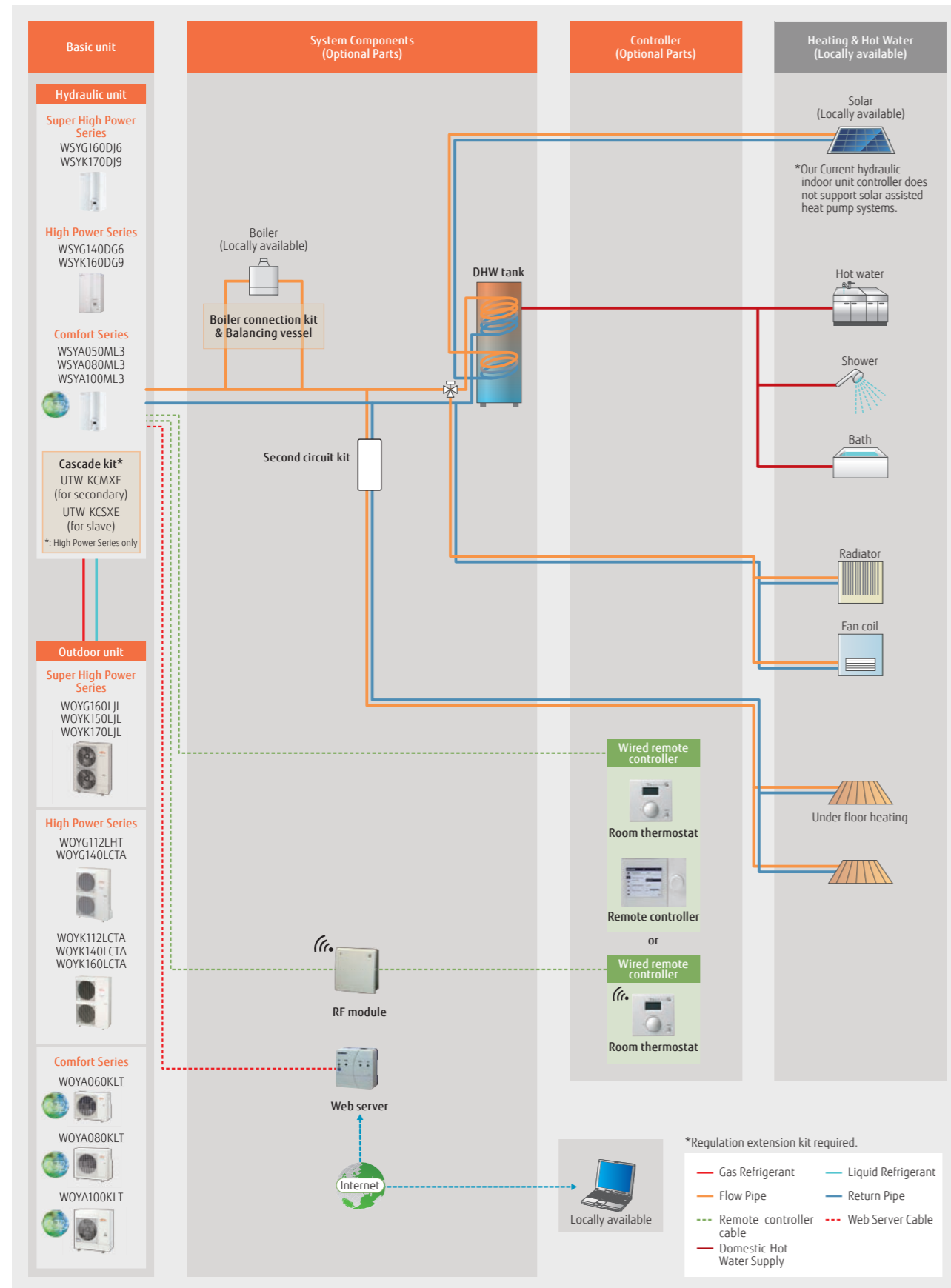

Split DHW Integrated Type

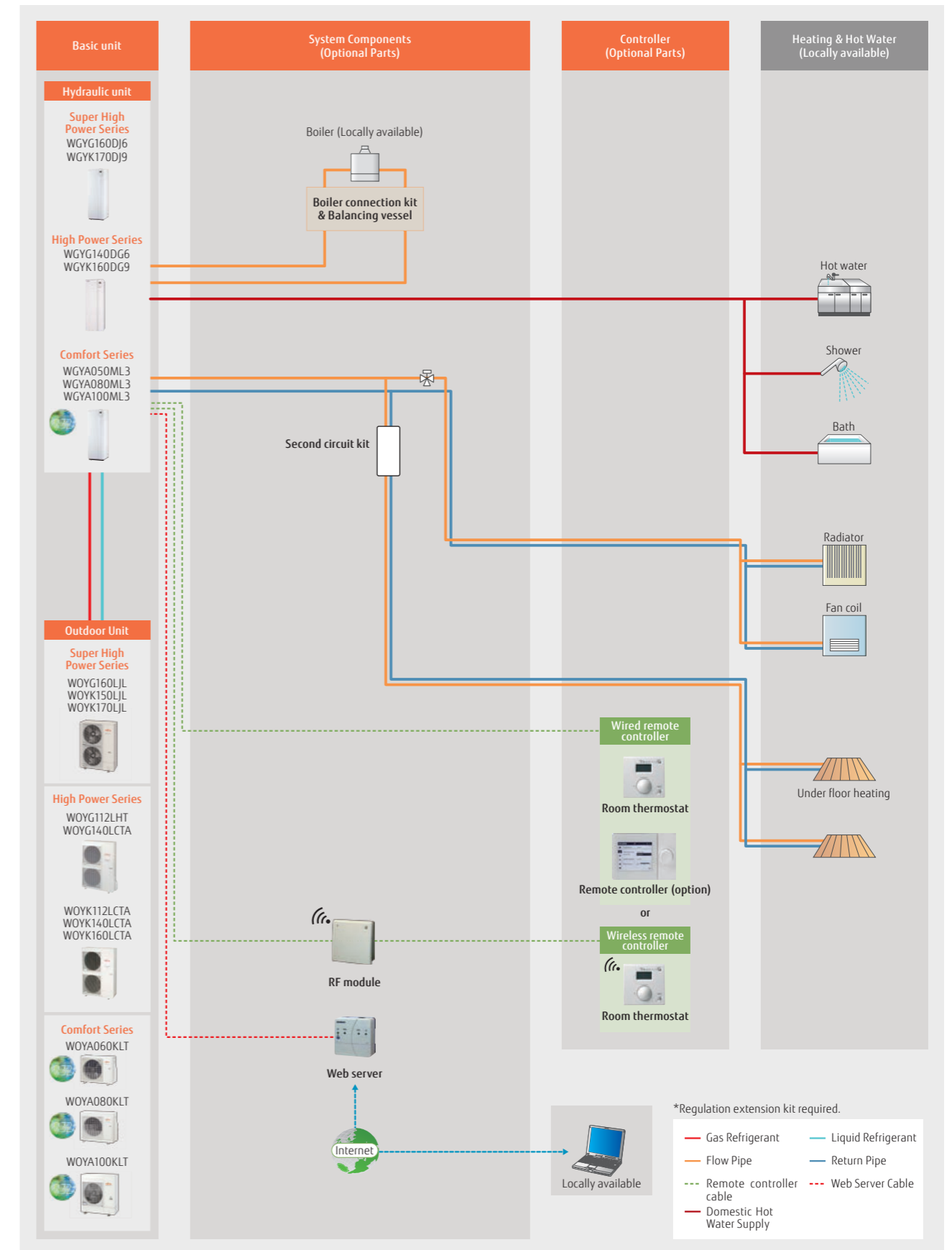

Case Studies

Split Type

2-emitter simultaneous heating (Individual control)
Underfloor heating + Radiator

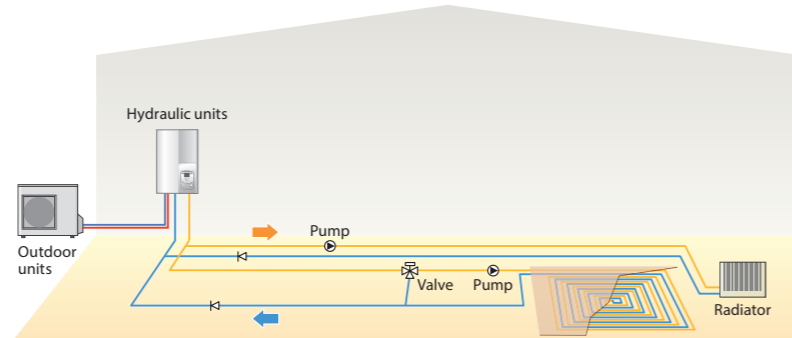

Boiler connected to heating (Boiler + Heating)

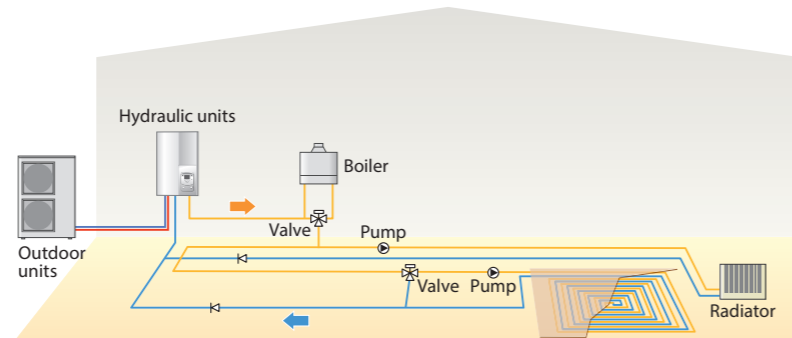

2-emitter simultaneous heating & domestic hot water supply (Cascade)

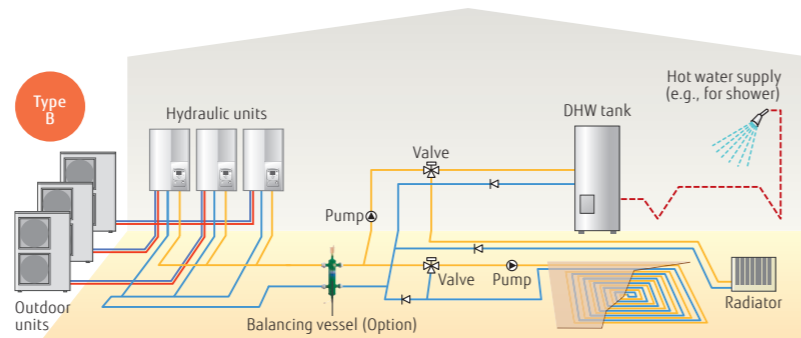
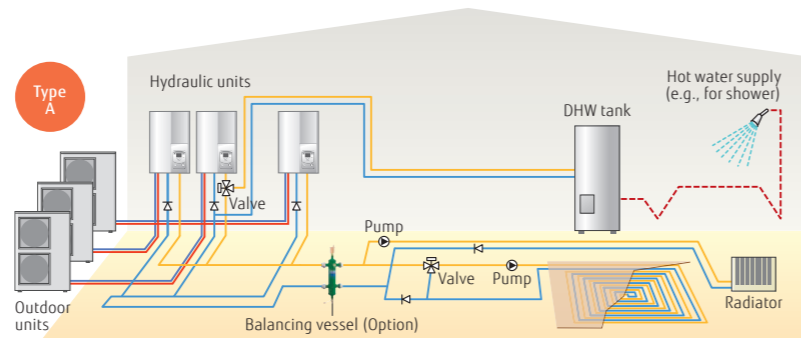

The hydraulic layouts shown are mainly representation. Please check with local dealer for actual hydraulic connections.

Split DHW Integrated Type

Single heating & domestic hot water supply
Radiator + domestic hot water supply

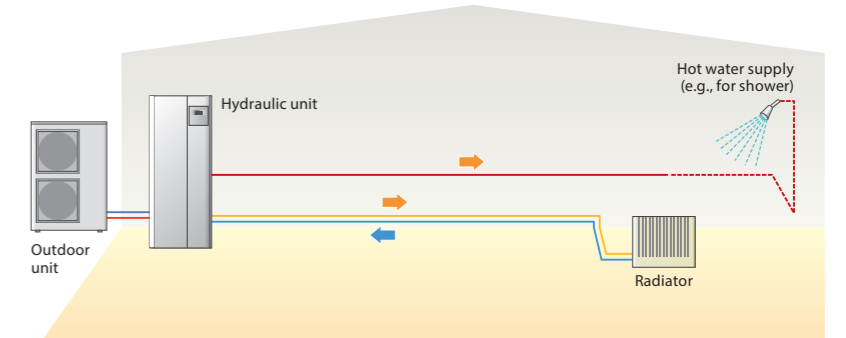

2-emitter simultaneous heating (Individual control) & domestic hot water supply
Radiator + domestic hot water supply

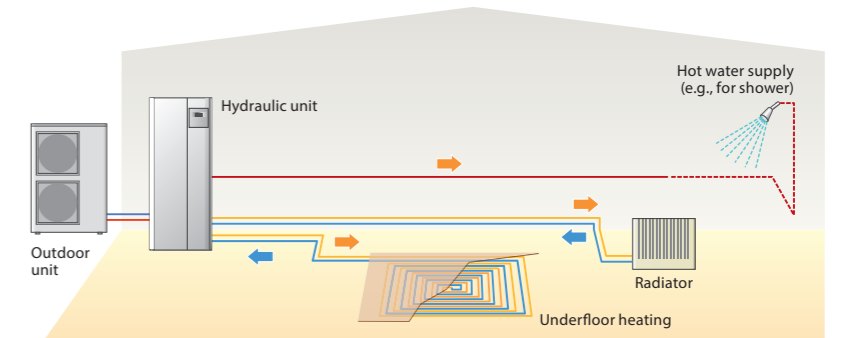

Boiler connected to heating (Boiler + Heating) and domestic hot water supply

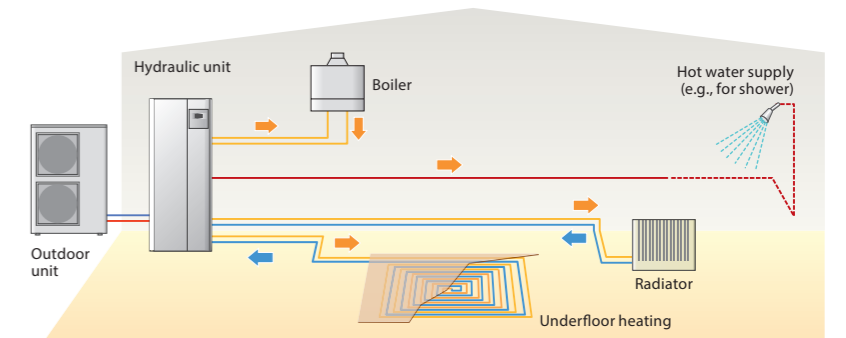

The hydraulic layouts shown are mainly representation. Please check with local dealer for actual hydraulic connections.

Simple installation

Presetting configurations

A controller installed makes it easy to configure the system without having to set each component or unit individually.

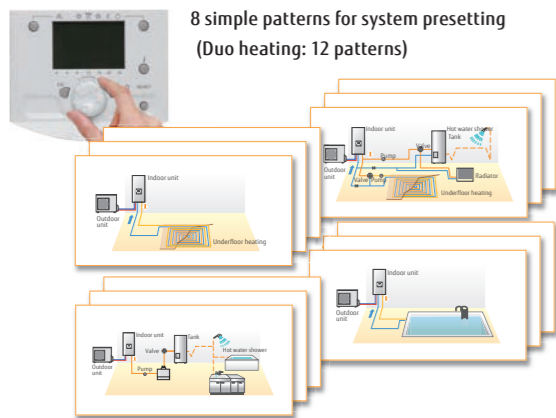

Configuration (Parameter 5700)	Installation type
Presetting 1	1 heating circuit
Presetting 2	2 heating circuits
Presetting 3	1 heating circuit with boiler backup
Presetting 4	2 heating circuits with boiler backup
Presetting 5	1/2 heating circuit with buffer control
Presetting 6	1/2 heating circuit with buffer control and boiler backup
Presetting 7	Cascade connection Primary
Presetting 8	Cascade connection A
Presetting 9	Cascade connection B/C

- DHW & solar control auto detection
- Pool heating and cooling option

Outdoor temperature simulation

It verifies that each unit operates properly under the set conditions and expected outdoor air temperature when the system is actually assembled.

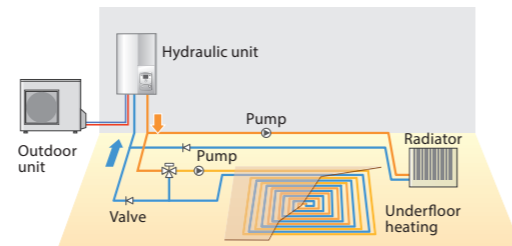

The outdoor temperatures can be simulated in the range of -50°C to +50°C.

Concrete floor drying

Allows the concrete surrounding the hot-water pipes to dry more quickly, shortening the construction period for underfloor heating installations.

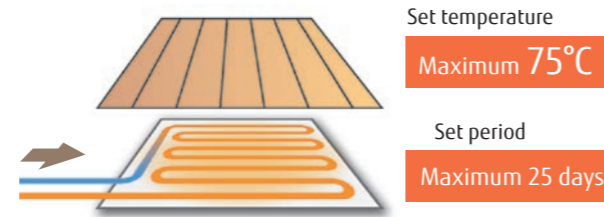

Controller with a large liquid crystal display and buttons for easy function setting

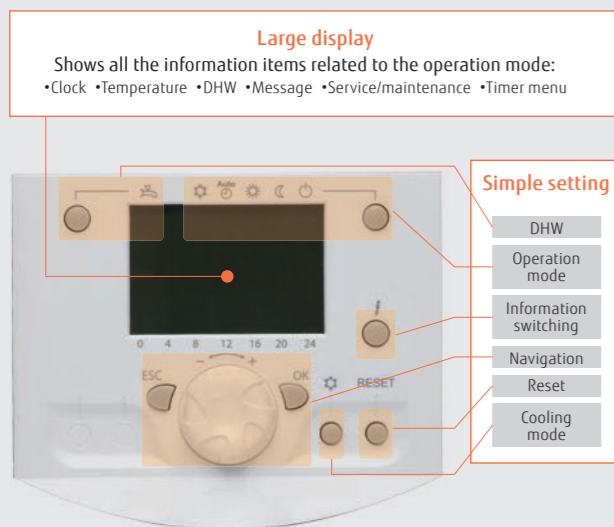

Main operation flow and settings for installers and end users

	Flow Chart	Example Item
Installers	1 Install Setting	Pump speed setting, Configuration, Heating curve setting, Heat pump shut off
	2 Option Setting	Cooling kit, DHW kit, Boiler kit, Swimming pool kit
	3 Convenient Function	Automatic heating curve setting, Underfloor controlled driving, Outdoor temperature adjustment, Maintenance period setting
	4 Workout	Outdoor temperature simulator
	5 Confirmation	Checking operation (Heating and cooling, DHW, option)
End users	6 User Setting	Date and time, Time program, Operation temperature setting

Easy Installation & Maintenance

- All hydraulic safety and control components are built in with no additional selection required.
- Lifting bars for installation free of difficulty or risk
- Easy access for maintenance
- Refrigerant pump down operation

Maintenance Support

Diagnostics functions for troubleshooting

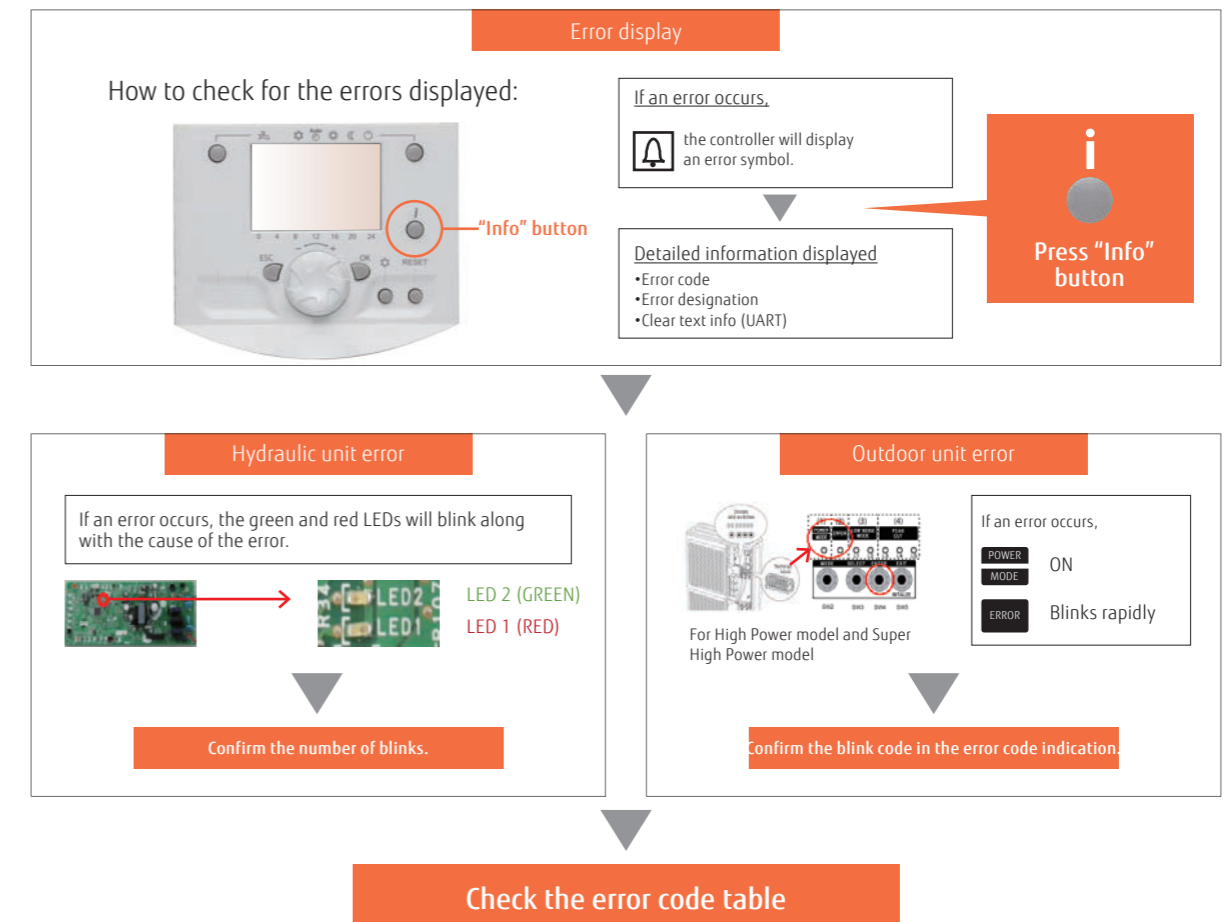

Installation requirements

Installation of equipment & electrical wiring

Split type Hydraulic unit

- The Hydraulic unit is hung on the wall.
- Weight ≤ 88 kg (including water)
- Space for maintenance needs to be taken into consideration.

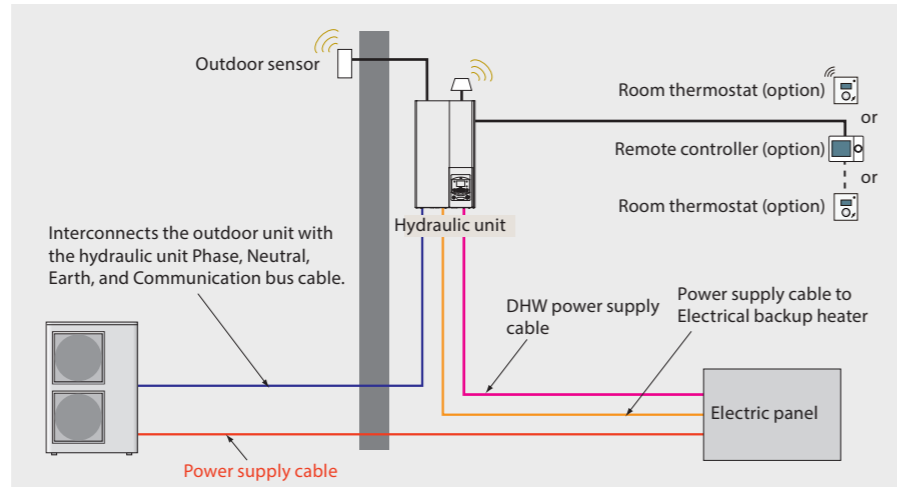
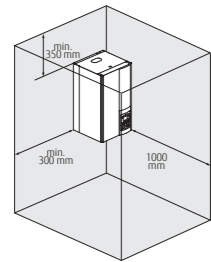

Split DHW Integrated Type Hydraulic Unit

- Floor standing
- Weight ≤ 393 kg (including water)
- Space for maintenance needs to be taken into consideration.

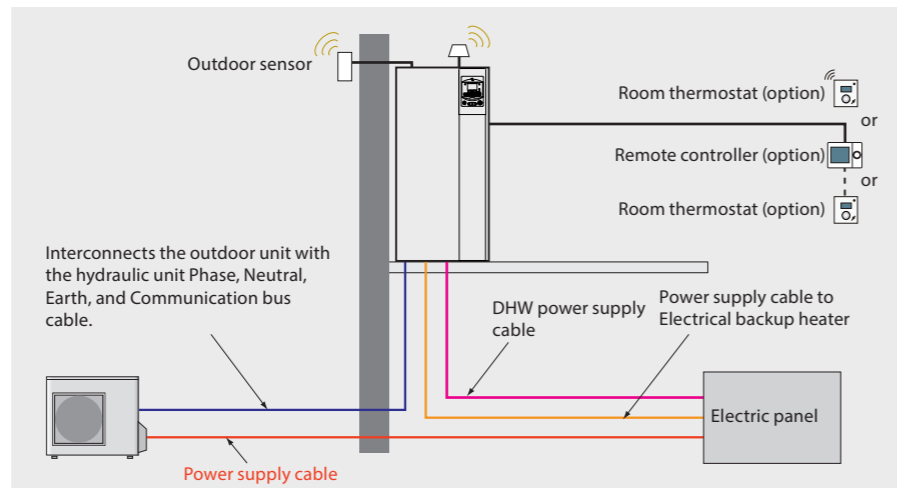
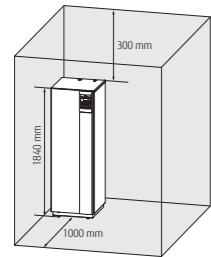

Piping and Wiring split type

Series	Capacity range (kW)	Pipe diameter (Liquid/Gas) (mm)	H1 (m)	H2 (m)	L (m)
R32 Comfort	5	6.35/12.70	+20	-20	3-30
	6				
	8				
High Power	10	9.52/15.88	+15	-15	5-20
	11				
	14				
Super High Power	15	9.52/15.88	+15	-25	5-30
	16				
	17				

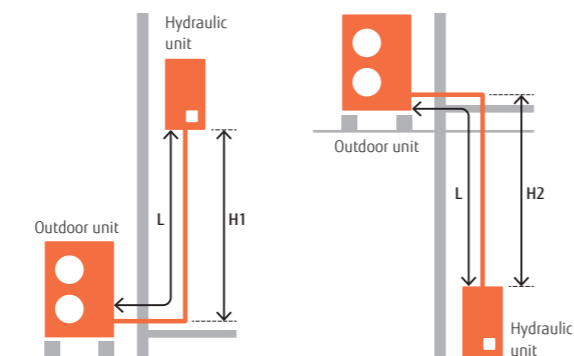

AIR TO WATER Optional Parts

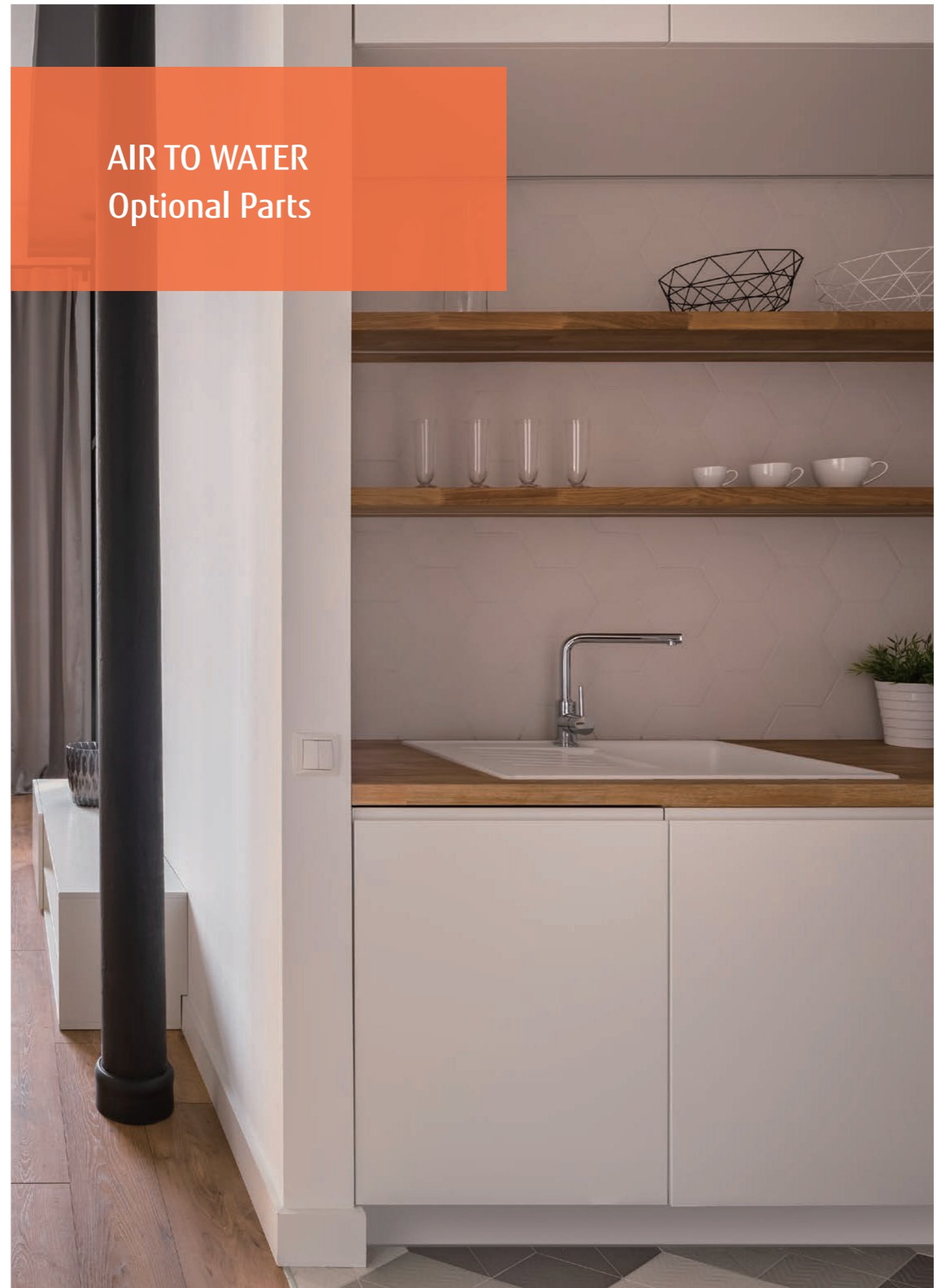

Optional Parts

Product Name	Model Name	Split Type										Split DHW Integrated Type												
		Super High Power			High Power				R32 Comfort			Super High Power			High Power				R32 Comfort					
		1Ø	3Ø		1Ø	3Ø		1Ø	3Ø		1Ø	3Ø		1Ø	3Ø		1Ø	3Ø						
		16	15	17	11	14	11	14	16	5	6	8	10	16	15	17	11	14	11	14	16	5	6	8
Second circuit Kit	UTW-KZSXE	-	-	-	•	•	•	•	•	•	•	•	-	-	-	-	-	-	-	-	-	-	-	-
	UTW-KZDXE	-	-	-	-	-	-	-	-	-	-	-	-	-	•	•	•	•	•	•	•	•	•	•
	UTW-KZSXJ	•	•	•	-	-	-	-	-	-	-	-	-	-	-	-	-	-	-	-	-	-	-	-
	UTW-KZDXJ	-	-	-	-	-	-	-	-	-	-	-	•	•	•	-	-	-	-	-	-	-	-	-
Boiler connection kit	UTW-KBSXD	-	-	-	•	•	•	•	•	•	•	•	-	-	-	-	-	-	-	-	-	-	-	
	UTW-KBDXD	-	-	-	-	-	-	-	-	-	-	-	-	-	•	•	•	•	•	•	•	•	•	
	UTW-KBSXJ	•	•	•	-	-	-	-	-	-	-	-	•	•	•	-	-	-	-	-	-	-	-	
Balancing vessel	UTW-TEVXA	•	•	•	•	•	•	•	•	•	•	•	•	•	•	•	•	•	•	•	•	•	•	
DHW kit	UTW-KDWXD (External)	•	•	•	•	•	•	•	•	•	•	•	•	•	•	•	•	•	•	•	•	•	•	
DHW tank	200 Liters 300 Liters UTW-T20AXH UTW-T30AXH	•	•	•	•	•	•	•	•	•	•	•	•	•	•	•	•	•	•	•	•	•	•	
	200 Liters 300 Liters UTW-T20BXH UTW-T30BXH	•	•	•	•	•	•	•	•	•	•	•	•	•	•	•	•	•	•	•	•	•	•	
DHW expansion kit	UTW-KDEXE	-	-	-	-	-	-	-	-	-	-	-	-	-	•	•	•	•	•	•	•	•	•	
	UTW-KDEXL	-	-	-	-	-	-	-	-	-	-	-	-	-	-	-	-	-	-	•	•	•	•	
Circulating pump	UTW-PHFXG	•	•	•	•	•	•	•	•	•	•	•	•	•	•	•	•	•	•	•	•	•	•	
Swimming pool kit	UTW-KSPXD*6	•	•	•	•	•	•	•	•	•	•	•	•	•	•	•	•	•	•	•	•	•	•	
Cooling kit	UTW-KCLXD	•	•	•	•	•	•	•	•	•	•	•	•	•	•	•	•	•	•	•	•	•	•	
	UTW-KCLXL	-	-	-	-	-	-	-	-	-	-	-	-	-	-	-	-	-	-	•	•	•	•	
Regulation extension kit	UTW-KREXD	•	•	•	•	•	•	•	•	•	•	•	•	•	•	•	•	•	•	•	•	•	•	
Drain pan	UTW-KDPXB	-	-	-	-	-	-	-	•	•	•	•	-	-	-	-	-	-	-	•	•	•	•	
Cascade master kit (incl. LPB clip)	UTW-KCMXE	-	-	-	•	•	•	•	•	•	•	•	-	-	-	-	-	-	-	-	-	-	-	

Product Name	Model Name	Split Type										Split DHW Integrated Type											
		Super High Power			High Power				R32 Comfort			Super High Power			High Power				R32 Comfort				
		1Ø	3Ø		1Ø	3Ø		1Ø	3Ø		1Ø	3Ø		1Ø	3Ø		1Ø	3Ø					
		16	15	17	11	14	11	14	16	5	6	8	10	16	15	17	11	14	11	14	16	5	6
Cascade slave kit (incl. LPB clip)	UTW-KCSXE	-	-	-	•	•	•	•	•	-	-	-	-	-	-	-	-	-	-	-	-	-	-
HMI kit	UTW-KHMXE*2	•	•	•	•	•	•	•	•	•	•	•	•	•	•	•	•	•	•	•	•	•	•
Remote controller	UTW-C74TXF*2	•	•	•	•	•	•	•	•	•	•	•	•	•	•	•	•	•	•	•	•	•	•
	UTW-C74HFX*2	•	•	•	•	•	•	•	•	•	•	•	•	•	•	•	•	•	•	•	•	•	•
Room thermostat	Wired UTW-C55XA	•	•	•	•	•	•	•	•	•	•	•	•	•	•	•	•	•	•	•	•	•	•
	Wireless UTW-C58XD	•	•	•	•	•	•	•	•	•	•	•	•	•	•	•	•	•	•	•	•	•	•
Outdoor sensor transmitter	UTW-MOSXD	•	•	•	•	•	•	•	•	•	•	•	•	•	•	•	•	•	•	•	•	•	•
RF modules for BSB-Port	UTW-MRCXD	•	•	•	•	•	•	•	•	•	•	•	•	•	•	•	•	•	•	•	•	•	•
Web server	UTW-KW1XD UTW-KW4XD	•	•	•	•	•	•	•	•	•	•	•	•	•	•	•	•	•	•	•	•	•	•
LPB clip	UTW-KL1XD	•	•	•	•	•	•	•	•	•	•	•	•	•	•	•	•	•	•	•	•	•	•
MODBUS® clip	UTW-KMBXJ	•*5	•*5	•*5	•*5	•*5	•*5	•*5	•*5	-	-	-	-	•*5	•*5	•*5	•*5	•*5	•*5	•*5	•*5	•*5	
Service tool (incl. OCI700 Adapter)	UTW-KSTXD	•*3	•*3	•*3	•*3	•*3	•*3	•*3	•*3	•*3	•*3	•*3	•*3	•*3	•*3	•*3	•*3	•*3	•*3	•*3	•*3	•*3	•*3
Service tool software	UTW-KPSXD	•*4	•*4	•*4	•*4	•*4	•*4	•*4	•*4	•*4	•*4	•*4	•*4	•*4	•*4	•*4	•*4	•*4	•*4	•*4	•*4	•*4	•*4
External connect kit	UTY-XWZXZ2	-	-	-	•	•	•	•	•	-	-	-	-	-	-	-	-	-	-	•	•	•	•
	UTY-XWZXZ3	•	•	•	-	-	-	-	-	-	-	-	-	-	•	•	•	-	-	-	-	-	-
Electrical backup heater relay	UTW-KBHXL	-	-	-	-	-	-	-	•	•	•	•	-	-	-	-	-	-	-	•	•	•	•

•: Available -: Not Available

*1: Split DHW integrated type supplies DHW without the DHW kit and DHW tank.
 *2: Includes 19 languages with no need to prepare an RC for Eastern Europe separately. C74TXF has a built-in room temperature sensor. C74HFX has a built-in room temperature and humidity sensor.
 *3: UTW-KL1XD is required for the connection.
 *4: UTW-KW1XD or UTW-KW4XD is required for the connection.
 *5: Additional optional parts required.
 *6: When using the Swimming pool kit (UTW-KSPXD), other devices (Radiator, DHW tank etc.) cannot be connected in the same system.

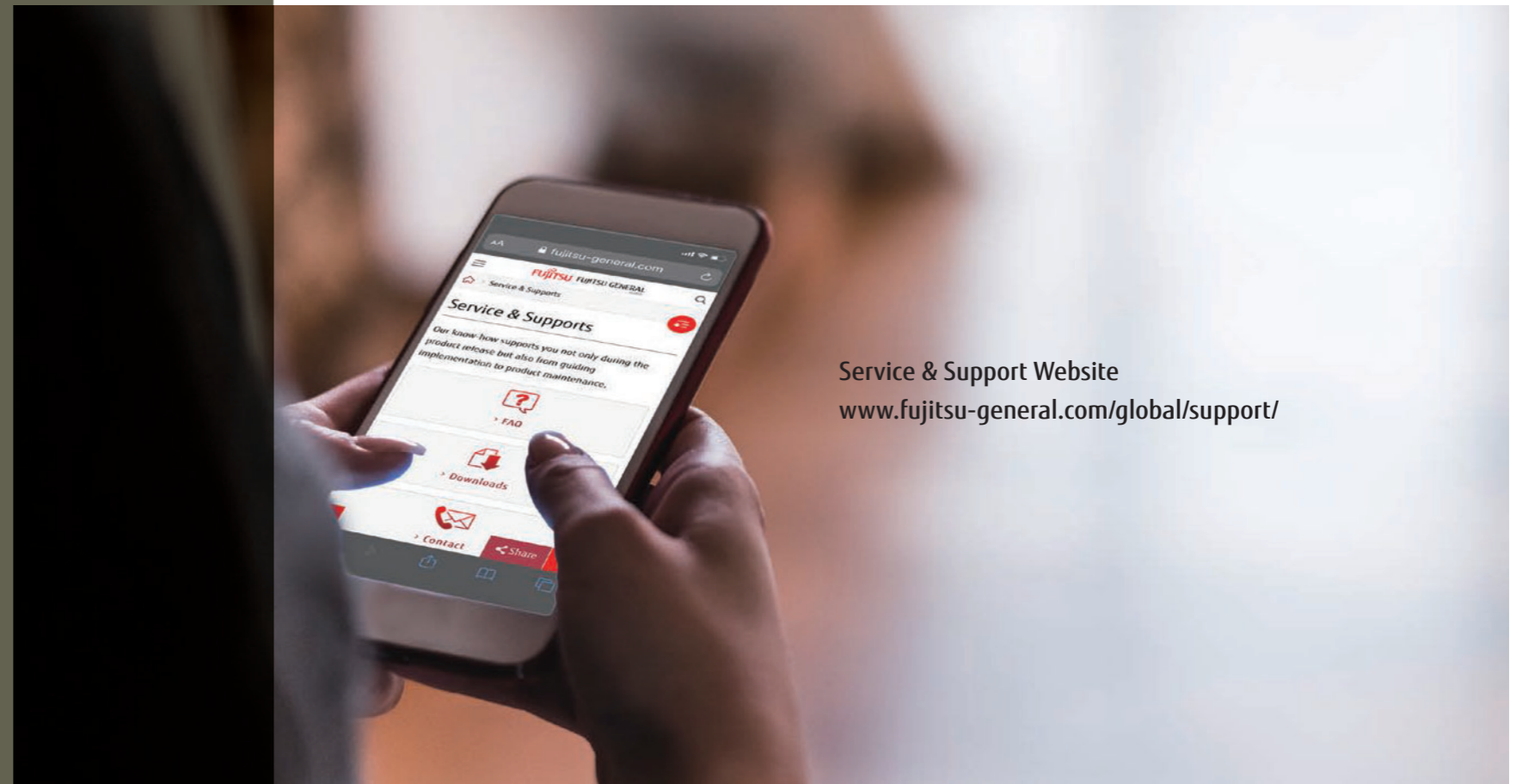

Service & Support Website
www.fujitsu-general.com/global/support/

SUPPORT

- Sp-002 AIRSTAGE™ Support
- Sp-004 AIRSTAGE™/RAC Support Tool
- Sp-006 WATERSTAGE™ Support Tool
- Sp-008 Quick Service & Maintenance
- Sp-010 Service Tool
- Sp-011 Web Monitoring Tool

Our knowledgeable sales and service representatives assist you, from product selection to installation and maintenance.

Category	Information material										Tool							
	Product sales training material	Product technical training material	Product news	Brochures	Promotional movies	Operation manuals	Design & Technical manuals	Certification data	2D CAD data	3D CAD (Revit) data	Installation manuals	Service manual	WATERSTAGE™ Package label creator	Design simulator (Room air conditioner, Packaged air conditioner, and VRF)	WATERSTAGE™ proposer	CFD simulation	Service tool and Web monitoring tool	Mobile technician
Product training	●	●																
Product information seeking			●	●	●	●	●											
Technical information seeking						●	●					●						
Model selection						●							●	●				
Design						●		●	●									
Verification																●		
Installation						●				●								
After-sales service											●						●	●

AIRSTAGE™ Support

Fujitsu General provides engineers and consultants with a wide range of product and technical information. In addition, we conduct research on new products and support design activities. We provide a wide range of support services from design to installation to maintain high quality.



Training facilities

Technical information

We provide equipment selection software that facilitates the design of air conditioning systems by providing performance data for the units and estimation for model selection.

Features

- Design & Technical manuals
- Model selection & estimation
- Certification data
- 2D/3D CAD data

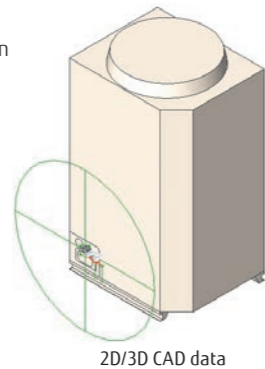

2D/3D CAD data

Product information

Information on new models is provided in the form of documents and movies in a timely manner for release, readily downloadable from the private section of our website. Contact your Fujitsu General representative for access information.

Features

- Product news
- Brochures & manuals
- Promotional movies



www.fujitsu-general.com/uk/support/downloads/vrf/

Technical support

Technical support is offered at every stage, from design through to installation, to assist in optimizing air conditioning solutions.

Features

- CFD simulation
- Guidelines
- Commissioning support

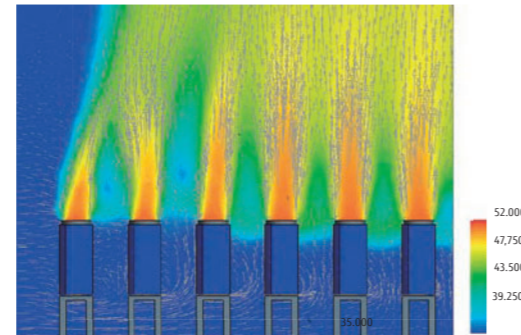

CFD simulation



Commissioning support



Fujitsu General regularly provides professional product, technical and service training at its training facilities worldwide. These research facilities also support the development of human resources with advanced technical skills.

Features

- Designing AIRSTAGE™ systems
- On-site training for control systems

- 1 Head office training center in Japan
- 2 Training center in China
- 3 Asia training center in Singapore
- 4 Europe training center in the United Kingdom
- 5 Europe training center in Germany
- 6 America training center in the United States
- 7 Middle East training center in the UAE
- 8 Oceania training center in Australia

AIRSTAGE™/RAC Support tool

Put the charts and pens away and design your projects on a computer using the Design simulator. Everything from selecting indoor and outdoor units, allocating controls and optional parts through to designing the piping and wiring systems is made easier using the program's built-in features. Once the project design is complete, the Export function makes it easy to generate material lists, product specifications, and refrigerant calculations, and more. You can also export in Word, Excel, and Acrobat formats, as well as group CAD data related to your project.



Design simulator

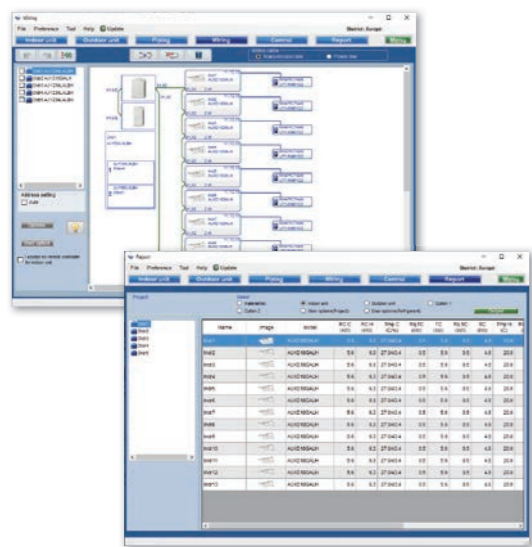

Outputs in the format that matches the application

You can export your project information in a number of industry standard file formats.

- Word format (rtf) (doc)
- Excel format (csv)
- Acrobat format (pdf)
- 2D CAD data (DXF)

Automatically create model selection information

- The required performance, type, and temperature conditions for each indoor unit are entered and then dragged and dropped onto the outdoor unit to automatically set each unit.
- Creates piping and wiring diagrams automatically to facilitate branching, grouping, and option settings.
- The additional refrigerant charging is automatically calculated when the pipe length is entered.
- Easy configuration of remote controller groups, central controller, and converters.
- The equipment list including the equipment information is created automatically.

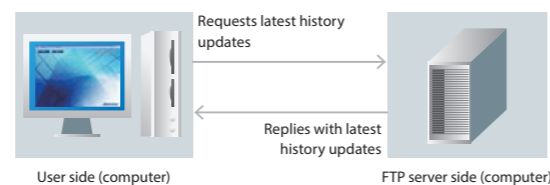

Update your Design simulator

The database can be updated easily online with the AutoUpdate function using FTP.

NEW BIM Building information modeling



BIM files of Fujitsu General's products are available on BIMobject®

Fujitsu General is releasing BIM files of our products on the BIMobject® website BIMobject.com.

Outline of BIMobject®
BIMobject® is a game changer for the construction industry, offering development, maintenance, and syndication of objects on the world's largest BIM platform.

About BIM files

- BIM files can be viewed in Autodesk Revit® 2018 version or later.
- In each BIM file, the location of the connectors for the refrigerant and drain pipe is different.
- Each BIM file includes several family types.
- A catalog and specification sheet is available in Revit file format for each product.

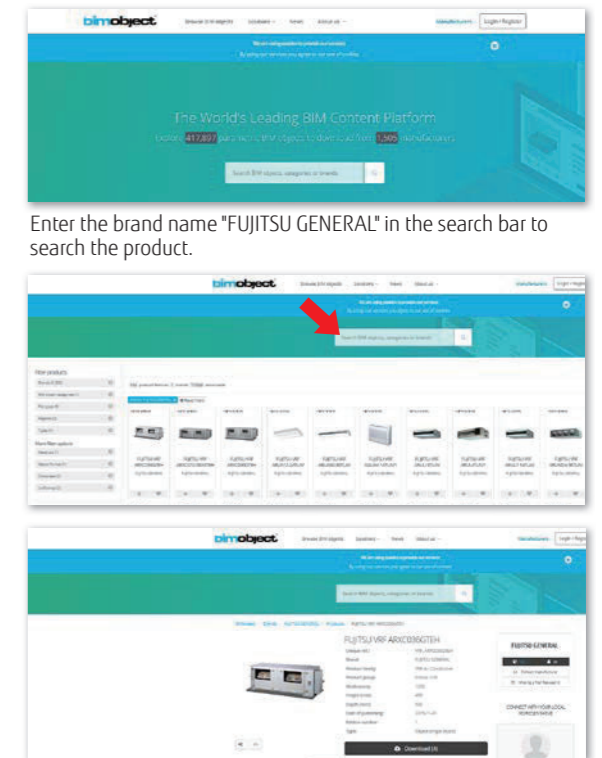

R RFA (Revit data)
A data format available for BIM-designed projects

Data content

- Shape (Size)
- Drain direction
- Pipe direction
- Power supply location
- It contains information about the above specifications.

Type catalog with product specifications

A DWG
a standard data format used for Autodesk products



DXF

Intermediate data commonly available in CAD products

- Data content**
- Shape (Size)

*To learn more about how to use BIM files, refer to the instructional video on each product page. youtu.be/wfL-hwFQ7dM

WATERSTAGE™ Support tool

Fujitsu General's software for WATERSTAGE™ automatically creates a combination of WATERSTAGE™ equipment by simply providing a few parameters. Supports multiple languages with an automatic update function.

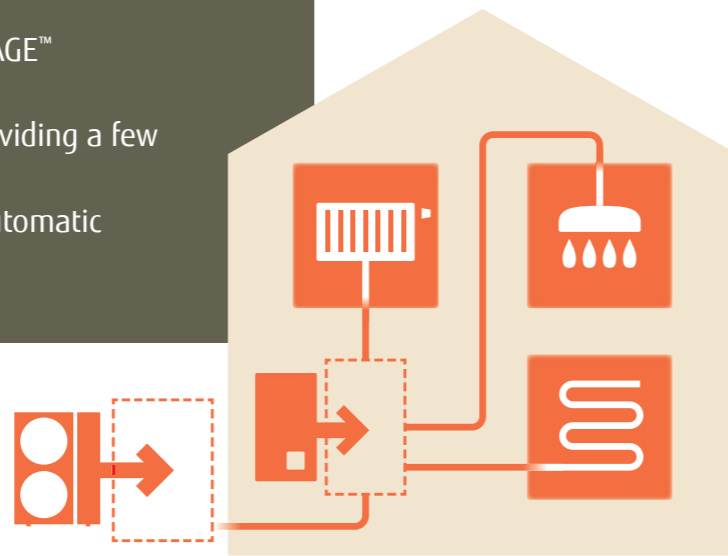

WATERSTAGE™ proposer

Selecting models with detailed technical information

- Simply enter the region where the equipment will be installed, the required heating capacity, the method of heating and other factors, and the software will select the appropriate equipment automatically.

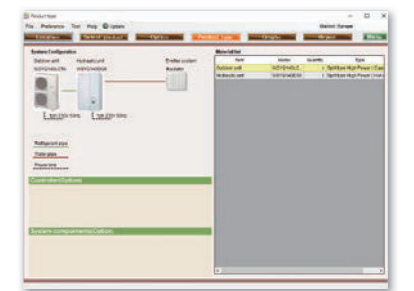

The images of the optional items will help you configure your system correctly. If more than one WATERSTAGE™ equipment is required, all relevant option items will be selected automatically.

The selected unit can be modified after reviewing the overall system configuration. The images and the list of devices are displayed at the same time, helping to avoid mistakes in device selection.



WATERSTAGE™ Package label creator

Download Energy labels and Fiches from our website

ErP documents such as Energy labels, Product fiches, Package labels, Package lists, Information sheets, and EC Declarations can be searched for and downloaded from our website.

We will also provide an online service in the future so that installers can easily create various package labels and package fiches for different models.

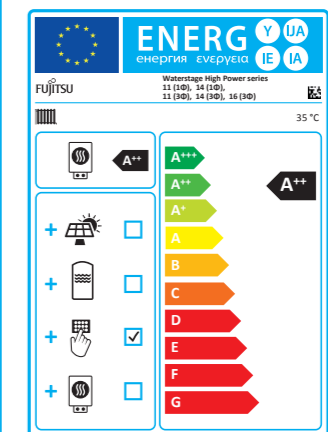
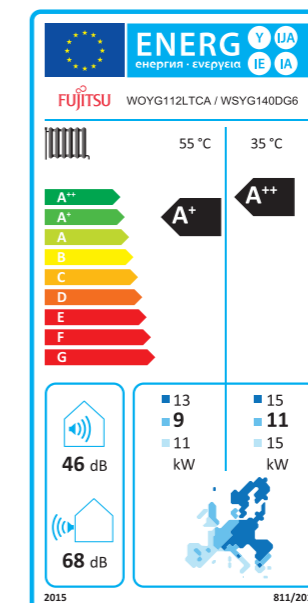

Quick service & maintenance

In the unlikely event that a problem should occur with the unit or system, a wide variety of support tools are available to assist with prompt service and maintenance anytime, anywhere, including error code displays on the product, service tools to check the detailed status of the entire system, and remote monitoring tools using the internet.



Easy maintenance & monitoring

Designed for easy maintenance

The operating status of the air conditioner and detailed trouble conditions are displayed on the 7-segment indicator lamp on the outdoor unit printed circuit board (PCB) and on the screen of the remote controller. Check the status of the unit quickly for a prompt response.

- Display the operation mode at the time.
- Discharge temperature and pressure
- Compressor operation status
- "Address/Type/Number" of the outdoor unit
- Error code

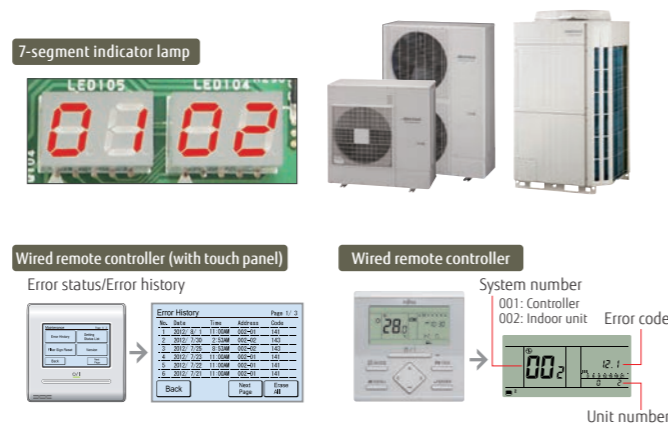

Error diagnosis by Service tool

Connect Service tool to check the status details of units, from single split to VRF, on a computer screen. Check the errors quickly for prompt countermeasures.

- Operating status/control
- Monitoring operating conditions
- Monitoring sensor data
- Indicating trend graphs
- Error history
- Indicating refrigerant circuit diagrams (for VRF)

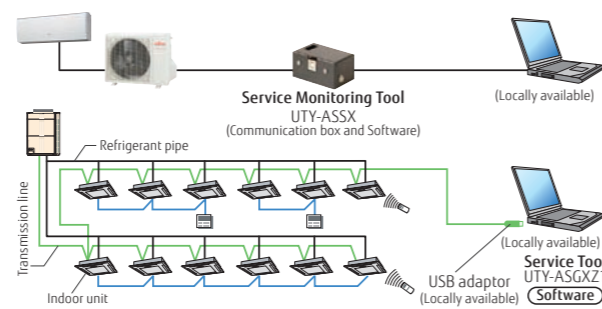

Remote monitoring

VRF system operating status and trouble status details can be monitored remotely at any time via the internet. Prompt coordination is available with service personnel.

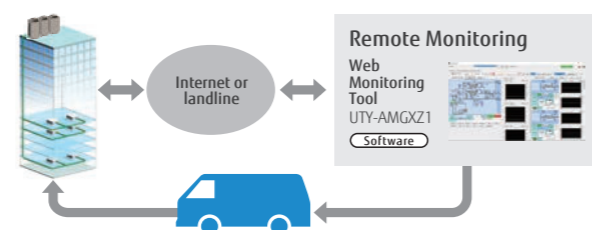

Mobile troubleshooting App for iOS and Android™ devices

We will release an App for troubleshooting tools for iPhone, iPod touch and other Apple devices, and Android products for Fujitsu General air conditioners (Room air conditioner/Packaged air conditioners VRF and ATW, "FGLair", and R32 calculation of allowable refrigerant capacity)

Use Error Code Check, Troubleshooting, and Sensor Check to understand the status of your air conditioner. xxx



Service monitoring tool for Single split, Multi-split & Air to water



- A quick overview of the temperature sensor readings and the electronic expansion valves (EEVs), fans, compressors and other control components
- It is not always easy to read the temperature sensor and know the status of the control components. So let the Service monitoring tool judge them.
- Visualizes protected operations
- Troubleshoots intermittent problems effectively
- Provides proof of normal operation to customers during periodical maintenance

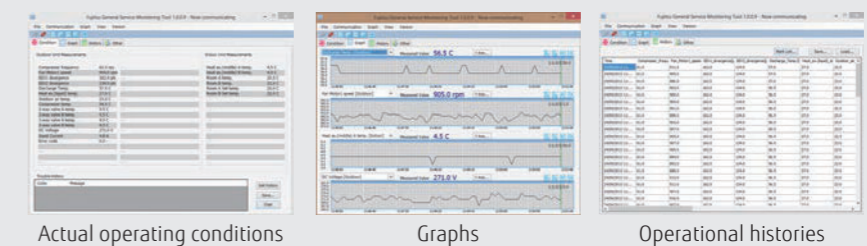

	UTY-ASSX
Dimensions (H × W × D) (mm)	60 × 160 × 160
Weight (g)	500

Service tool

Extensive monitoring and analysis functions that make installation and maintenance easier

- The operation status of the system can be monitored and analyzed to detect any malfunctions.
- Data on the operation status of the system can be stored on a computer to allow for remote access.
- Up to 400 indoor units in a single VRF network system can be controlled and monitored for a large building or hotel.
- This software can be connected to any point of transmission line with a USB adaptor (locally available).

* Saved data can be displayed offline. Note that the data saved by the following software applications cannot be displayed.

- UTR-YSTB/UTR-YSTC (Service tool)
- UTR-YMSA (Web monitoring tool)

Automatic operation check for refrigeration cycles

Once installed, the Service tool automatically checks for refrigeration cycles. The self-diagnosis function determines whether each sensor value is normal, which reduces the need for manual checks. The result of a diagnosis can be provided in a report.

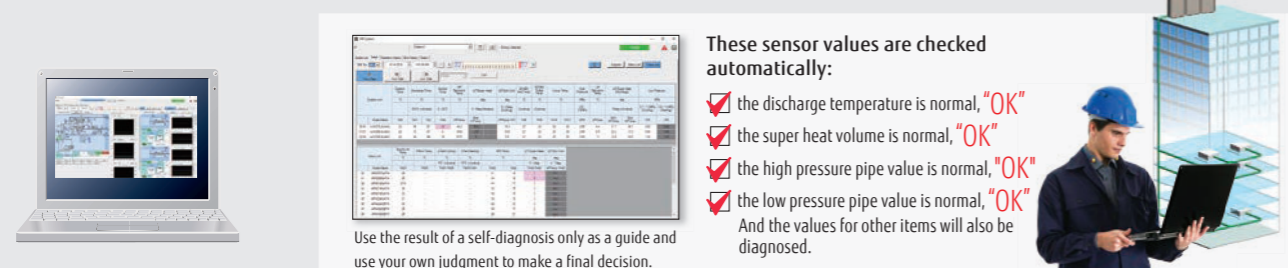

Use the result of a self-diagnosis only as a guide and use your own judgment to make a final decision.

These sensor values are checked automatically:

- ✓ the discharge temperature is normal, "OK"
- ✓ the super heat volume is normal, "OK"
- ✓ the high pressure pipe value is normal, "OK"
- ✓ the low pressure pipe value is normal, "OK"

And the values for other items will also be diagnosed.

Remote technical support and maintenance

On-site check screen can be shared between on-site staff and a service technician in a remote location. When a service technician visits the site for troubleshooting, the system's operation status can be shared in real time with a remote service center for assistance. On-site staff can have an online chat with a remote service center to get further assistance.

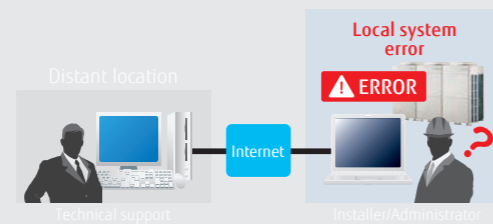

Trend charts

Previous-generation application could display only 3 sets of data from sensors. However, the current generation of the service tool displays multiple charts simultaneously so that refrigeration cycles can be monitored and checked in greater detail.

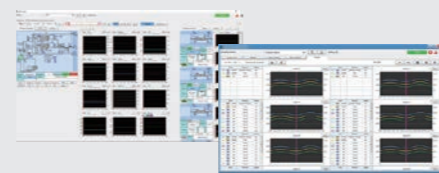

Computer requirements

UTY-ASGXZ1	
Operating system	• Microsoft® Windows® 7 Professional (32-bit or 64-bit) SP1 • Microsoft® Windows® 8.1 Pro (32-bit or 64-bit) • Microsoft® Windows® 10 Pro (32-bit or 64-bit)
CPU	1 GHz or higher
Memory	• 1 GB or more (for Windows® 7 [32-bit], Windows® 8.1 [32-bit], and Windows® 10 [32-bit]) • 2 GB or more (for Windows® 7 [64-bit], Windows® 8.1 [64-bit], and Windows® 10 [64-bit])
HDD	40 GB or more of free space
Screen resolution	1366 × 768 pixels or higher
Interface	• USB port for U10 USB Network interface and software protection key
Software	Internet Explorer® 11 or Microsoft Edge

Packing list

Name	Quantity	Application
White-USB-key (Software protection key)	1	Software protection key to be connected to a USB port on a Service tool-installed computer. This software runs only on a computer with WibuKey.

- Computer requirements
- Echelon® U10 USB Network Interface – TP/FT-10 Channel (Model name: 75010R) (Required for each VRF Network)

Web monitoring tool

Features

- Troubleshooting is performed by monitoring each air conditioning unit remotely during a periodical system check.
- An error notification is automatically transmitted to several locations via the internet*1.
- Requires either a dedicated internet connection or landline to operate.
- The occurrence of an error can be confirmed through an error alert and equipment status information obtained from a remote location.
- Monitoring data can be downloaded in a remote location. These data can be accessed and displayed even when the service tool is in offline mode.
- Can be viewed on the monitoring computer's Web browser without installing any special software.

*1: Internet e-mail access required.

Web Monitoring System

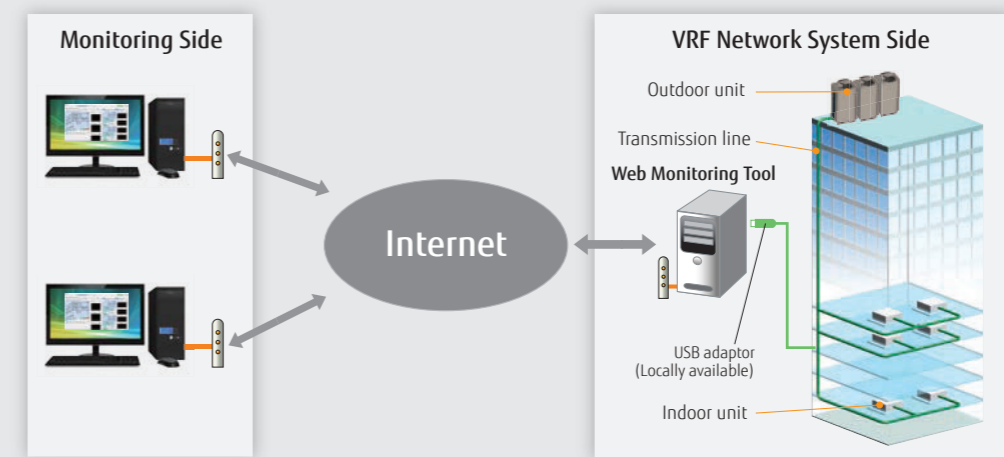

Supporting up to 4 VRF network systems

Up to 4 USB adaptors can be connected to a computer, enabling the monitoring of up to 1,600 indoor units.

Suitable for use in a large building or hotel.

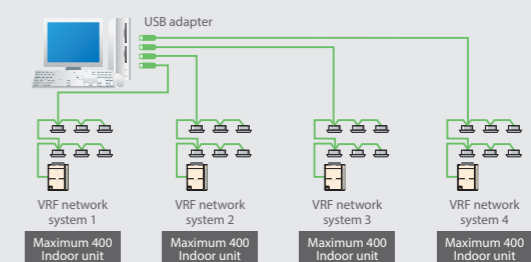

Computer requirements

UTY-AMGXZ1	
Operating system	• Microsoft® Windows® 7 Professional (32-bit or 64-bit) SP1 • Microsoft® Windows® 8.1 Pro (32-bit or 64-bit) • Microsoft® Windows® 10 Pro (32-bit or 64-bit)
CPU	1 GHz or higher
Memory	• 1 GB or more (for Windows® 7 [32-bit], Windows® 8.1 [32-bit], and Windows® 10 [32-bit]) • 2 GB or more (for Windows® 7 [64-bit], Windows® 8.1 [64-bit], and Windows® 10 [64-bit])
HDD	40 GB or more of free space
Screen resolution	1366 × 768 pixels or higher
Interface	• USB ports (one for U10 USB Network interface and up to 4 ports for software protection keys) • Interface for remote connection: - Landline: Modem is required. - Internet using LAN: Ethernet port is required.
Software	Internet Explorer® 11 or Microsoft Edge

Packing list

Name	Quantity	Application
White-USB-key (Software protection key)	1	Software protection key to be connected to a USB port on a Service tool-installed computer. This software runs only on a computer with WibuKey.

- Computer requirements
- Echelon® U10 USB Network Interface – TP/FT-10 Channel (Model name: 75010R) (Required for each VRF Network)